

MAINTENANCE

MAINTENANCE REQUIREMENTS ...	MA- 2	MANUAL TRANSMISSION OIL	MA-13
MAINTENANCE SCHEDULE	MA- 3	TRANSFER OIL	MA-14
SCHEDULE FOR SEVERE		DIFFERENTIAL	MA-14
DRIVING	MA- 5	PROPELLER SHAFT	MA-15
MAINTENANCE OPERATION	MA- 6	DRIVE SHAFT BOOT	MA-15
AIR CLEANER ELEMENT	MA- 6	SHOCK ABSORBERS	MA-15
VALVE CLEARANCES	MA- 6	WHEEL BEARINGS	MA-16
ENGINE OIL & OIL FILTER	MA- 6	STEERING LINKAGE	MA-16
FUEL LINE & CONNECTIONS	MA- 7	STEERING GEAR BOX	MA-16
ENGINE COOLANT	MA- 8	POWER STEERING PUMP FLUID	
DRIVE BELTS	MA-10	HOSE	MA-16
TIMING BELT	MA-10	WHEEL ALIGNMENT	MA-16
SPARK PLUGS	MA-10	BRAKE PEDAL	MA-17
BLOW-BY GAS RECIRCULATION		PARKING BRAKE	MA-18
HOSE	MA-11	FRONT BRAKE DISC &	
CHARCOAL CANISTER	MA-11	DISC PAD	MA-18
EVAPORATIVE EMISSION		BRAKE HOSES & TUBES	MA-18
HOSES	MA-12	P & B VALVE	MA-18
EXHAUST PIPE & MUFFLER		BRAKE FLUID	MA-19
MOUNTING	MA-12	BRAKE DRUM & LINING	MA-19
CLUTCH	MA-12	BRAKE BOOSTER VACUUM	
AUTOMATIC TRANSMISSION		HOSES	MA-19
OIL COOLER HOSES	MA-13	MASTER CYLINDER	MA-19
AUTOMATIC TRANSMISSION		WHEEL CYLINDERS	MA-20
FLUID	MA-13	WHEEL HUB NUTS	MA-20

JMA0001-00000

MAINTENANCE REQUIREMENTS

The scheduled maintenance service is important to ensure trouble-free, safe and economical driving. Failure to perform the scheduled maintenance may cause an accident or serious damage.

If you conduct the periodical maintenance, Daihatsu car owners may reduce the chance of accidents or car problems. Furthermore, it becomes possible for you to find at an earlier stage malfunctions which may lead to serious damages. Consequently, potential vehicle damage can be prevented or the degree of the damage can be minimized.

Therefore, all of the persons who are concerned with servicing the Daihatsu vehicles should offer the periodical maintenance service to Daihatsu car owners in order that they may be protected from accidents or unexpected problems.

To prevent malfunctions in advance, however, conducting the periodical maintenance service only is insufficient. It is essential that owners themselves perform maintenance, such as the pre-starting check described in the owner's manual, so that the vehicle exhibits no abnormal change or phenomenon. Hence, please explain to owners about the necessity of maintenance performed by them. However, malfunction may occur on those vehicles which are always checked by their owners. For instance, if a part instructed to be replaced periodically should be used beyond the replacement intervals and the life of the part has expired, there are cases where malfunction occurs suddenly despite the fact that no malfunction has taken place until yesterday. To prevent such malfunction in advance, be sure to replace parts recommended to be replaced periodically at the specified replacement intervals.

This section describes those items of the scheduled maintenance service recommended by the Daihatsu and their intervals. Be sure to observe the maintenance schedule.

JMA00002-00000

10-1000	...
10-1001	...
10-1002	...
10-1003	...
10-1004	...
10-1005	...
10-1006	...
10-1007	...
10-1008	...
10-1009	...
10-1010	...
10-1011	...
10-1012	...
10-1013	...
10-1014	...
10-1015	...
10-1016	...
10-1017	...
10-1018	...
10-1019	...
10-1020	...
10-1021	...
10-1022	...
10-1023	...
10-1024	...
10-1025	...
10-1026	...
10-1027	...
10-1028	...
10-1029	...
10-1030	...
10-1031	...
10-1032	...
10-1033	...
10-1034	...
10-1035	...
10-1036	...
10-1037	...
10-1038	...
10-1039	...
10-1040	...
10-1041	...
10-1042	...
10-1043	...
10-1044	...
10-1045	...
10-1046	...
10-1047	...
10-1048	...
10-1049	...
10-1050	...

10-1051	...
10-1052	...
10-1053	...
10-1054	...
10-1055	...
10-1056	...
10-1057	...
10-1058	...
10-1059	...
10-1060	...
10-1061	...
10-1062	...
10-1063	...
10-1064	...
10-1065	...
10-1066	...
10-1067	...
10-1068	...
10-1069	...
10-1070	...
10-1071	...
10-1072	...
10-1073	...
10-1074	...
10-1075	...
10-1076	...
10-1077	...
10-1078	...
10-1079	...
10-1080	...
10-1081	...
10-1082	...
10-1083	...
10-1084	...
10-1085	...
10-1086	...
10-1087	...
10-1088	...
10-1089	...
10-1090	...

MAINTENANCE SCHEDULE

NOTE:

- Perform the periodical maintenance at the specified mileage or the time whichever comes first, unless otherwise specified.
- Continue to perform the periodical maintenance after 100,000 km (60,000 miles) at the same intervals as before 100,000 km.
- If the vehicle should be operated under severe driving conditions, operated occasionally, operated in dusty areas, repeating short trip, operated under extremely cold climate and/or on salted roads, it is necessary to perform some maintenance items more frequently than the regular maintenance schedule.
- This maintenance schedule prepared based on requirements mentioned in the owner's manual which are to be performed by the Daihatsu owner thoroughly.

○---Check or inspect. ●---Change or replace.

Section	Item	What to do	Inspection interval	×1000 km	1	10	20	30	40	50	60	70	80	90	100	
				×1000 miles	0.6	6	12	18	24	30	36	42	48	54	60	
				Years	—	0.5	1	1.5	2	2.5	3	3.5	4	4.5	5	
Engine	Air cleaner element	Cleaning Check • Damage					○		●		○		●		○	
	Valve clearance	Check & adjustment							○				○			
	Engine oil & oil filter	Change (Use API: SH or higher grade)		Every 15,000 km												
	Fuel filter	Change		Every 20,000 km												
	Fuel line & connections (Including fuel hoses)	Check • Crack • Tightness • Leakage • Damage		Every 40,000 km												
	Coolant (Long-life coolant)	Change		Every 2 years												
	Drive belt (Alternator, water pump, power steering)	Check • Tension • Crack • Damage				○		○		○		○		○		○
	Timing belt	Change		Every 100,000 km												
	Spark plug	Cleaning & check • Condition • Gap • Damage				○		○		○		○		○		○
Ignition timing	Check & adjustment				○		○		○		○		○		○	
Exhaust emission control system	Blow-by gas recirculation hose (Positive crankcase ventilation hose)	Check • Connection • Damage							○				○			
	Charcoal canister	Check • Function • Damage							○				○			
	Evaporative emission hoses	Change		Every 8 years												
	Exhaust pipe & muffler mounting	Check • Tightness • Damage				○		○		○		○		○		○

* Replace every 12,000 km when API SG multi grade oil is used.

○...Check or inspect. ●...Change or replace.

Section	Item	What to do	Inspection interval	×1000 km	1	10	20	30	40	50	60	70	80	90	100	
				×1000 miles	0.6	6	12	18	24	30	36	42	48	54	60	
				Years	—	0.5	1	1.5	2	2.5	3	3.5	4	4.5	5	
Power train system	Clutch	Check • Free travel • Reserve travel • Damage					○		○		○		○		○	
	Manual transmission	Change • Oil							●				●			
	Automatic transmission	Change • Fluid	Every 80,000 km													
	Automatic transmission Oil cooler hose	Check • Crack, scratch, cut, twist and swelling	Every 40,000 km													
	Transfer	Change • Oil							●					●		
	Differential (Front & Rear)	Change • Oil							●					●		
	Propeller shaft	Check • Tightness • Rattle • Damage				○			○			○		○		○
	Drive shaft boot	Check • Damage				○			○			○		○		○
Suspension system	Shock absorber	Check • Function • Oil leakage (Shock absorber) • Damage				○			○				○		○	
	Suspension arm (Front) Control arm (Rear) Dust boots	Check • Tightness • Damage							○					○		
Running system	Wheel bearing	Check • Tightness • Damage							○					○		
Steering system	Steering linkage, gear box	Check • Free play (Steering wheel) • Tightness • Rattle • Damage				○			○				○		○	
	Wheel alignment	Check • Toe-in							○					○		
	Fluid hose	Check • Crack, scratch, cut, twist and swelling	Every 4 years													

○...Check or inspect. ●...Change or replace.

Section	Item	What to do	Inspection interval	×1000 km	1	10	20	30	40	50	60	70	80	90	100
				×1000 miles	0.6	6	12	18	24	30	36	42	48	54	60
				Years	—	0.5	1	1.5	2	2.5	3	3.5	4	4.5	5
Brake system	Brake pedal & Parking brake	Check • Free play (Brake pedal) • Reserve travel (Brake pedal) • Working travel (Parking brake)					○		○		○		○		○
	Disc pad	Check • Wear • Damage				○		○		○		○		○	
	Brake hose, tube and P & B valve	Check • Leakage (Fluid level, connection) • Loose clamp • Damage				○		○		○		○		○	
	Brake fluid	Change		Every 2 years											
	Brake lining	Check • Wear • Damage				○		○		○		○		○	
	Brake booster vacuum hose	Check		Every 4 years											
	Master & wheel cylinder	Check • Leakage		Every 2 years											
Chassis & body	Wheel hub nut, other bolts & nuts	Check • Tightness				○		○		○		○		○	

JMA00003-00000

SCHEDULE FOR SEVERE DRIVING

○...Check or inspect. ●...Change or replace.

Section	Item	What to do	Inspection interval	×1000 km	1	10	20	30	40	50	60	70	80	90	100
				×1000 miles	0.6	6	12	18	24	30	36	42	48	54	60
				Years	—	0.5	1	1.5	2	2.5	3	3.5	4	4.5	5
Engine	Engine oil & oil filter	Change		Every 5,000 km											
	Air cleaner element	Check & cleaning • Damage Change		Check and cleaning: Every 5,000 km Replacement: Every 20,000 km											
Exhaust emission control system	Exhaust pipe and mounting	Check • Tightness • Damage			○	○	○	○	○	○	○	○	○	○	○
Power train system	Manual transmission	Change • Fluid		Every 25,000 km											
	Automatic transmission	Change • Fluid		Every 50,000 km											
	Transfer	Change • Fluid		Every 25,000 km											
	Differential (Front & Rear)	Change • Fluid		Every 25,000 km											
Steering system	Steering linkage	Check • Tightness • Damage			○	○	○	○	○	○	○	○	○	○	○
Brake system	Disc & disc pad	Check • Wear • Damage			○	○	○	○	○	○	○	○	○	○	○
	Brake drum & lining	Check • Wear • Damage			○	○	○	○	○	○	○	○	○	○	○

JMA00004-00000

MAINTENANCE OPERATION

AIR CLEANER ELEMENT

1. Perform checking every year or 20,000 kilometer running, whichever comes first.
2. If the vehicle has been run under severe driving environments, perform cleaning every 5,000 kilometer running. Also, replace the air cleaner element every 20,000 kilometer running.
3. Take out the air cleaner element from the air cleaner case. Check the element for oil contamination or restriction.
4. When cleaning, blow compressed air first from the downstream side of the air cleaner element. Then, blow compressed air from the upstream side so that dust or other contamination may be removed.

WARNING:

- Be sure to wear safety goggles during this operation.

CAUTION:

- The pressure of the compressed air should not exceed 392 KPa.

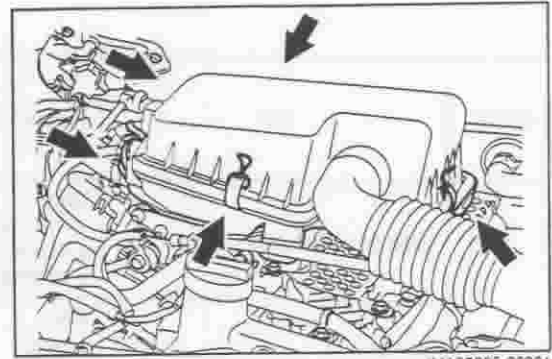

JMA00005-00001

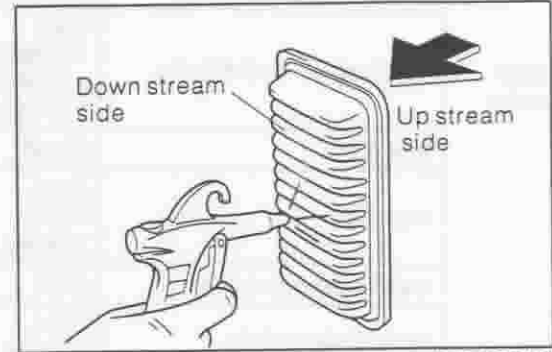

JMA00006-00002

VALVE CLEARANCES

1. Perform checking every two years or 40,000 kilometer running, whichever comes first.

NOTE:

- For the adjustment procedure, refer to Section EM.

Specified Values:

Intake: 0.18 $\begin{smallmatrix} +0.055 \\ -0.035 \end{smallmatrix}$ mm

Exhaust: 0.31 $\begin{smallmatrix} +0.055 \\ -0.035 \end{smallmatrix}$ mm

(During engine cold period)

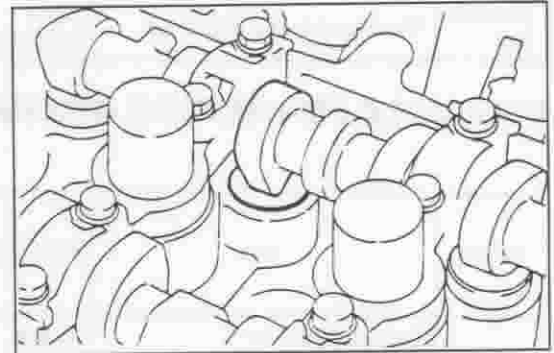

JMA00007-00003

ENGINE OIL & OIL FILTER

1. Change engine oil and replace the oil filter every 15,000 kilometer running.
2. If the vehicle has been run under severe driving environments, change engine oil and replace the oil filter every 5,000 kilometer running.
3. Park the vehicle at a level place. Place a suitable container under the engine oil drain plug and oil filter.

WARNING:

- There is the possibility that you may burn yourself during this operation when the engine is hot.

4. Remove the oil filter cap so that the engine oil may be drained easily. Then, remove the drain plug and drain the engine oil.
5. Remove the oil filter.

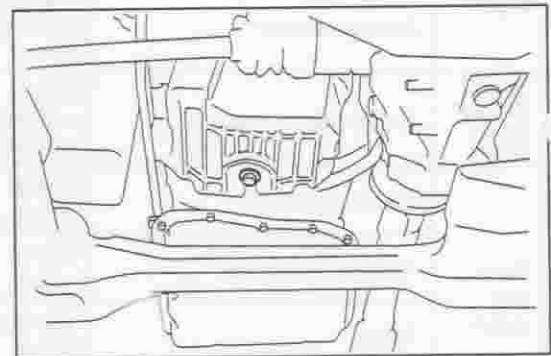

JMA00008-00004

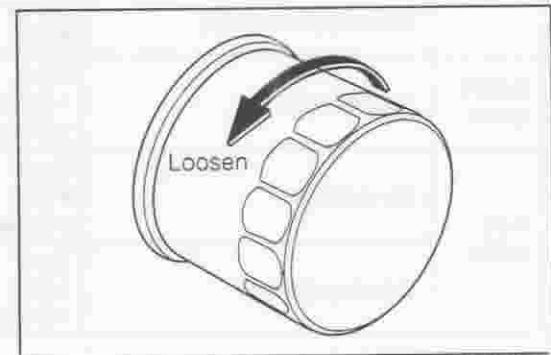

JMA00009-00005

6. Wipe off thoroughly residual oil at the oil filter installation section with a cloth or the like.
7. Apply a thin film of engine oil to the O-ring section of the oil filter.
8. Install the oil filter by turning it by your hand, until the O-ring of the oil filter may fit closely to the bracket.
9. Tighten the oil filter again by turning it another one-fourth turn with the following SST.

SST: 09228-87201-000

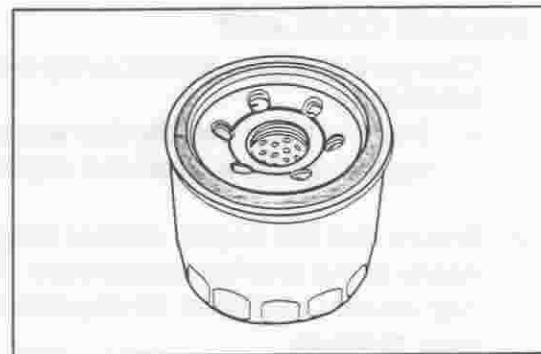

JMA00010-00006

10. Install the new gasket and drain plug to the engine oil pan.
Tightening Torque: 8.0 ± 1.6 N·m

11. Fill the engine oil.

CAUTION:

- The API grade oil of SH (5W-30) or higher should be used.
(The amount of oil to be filled is about 3.6 liters.)

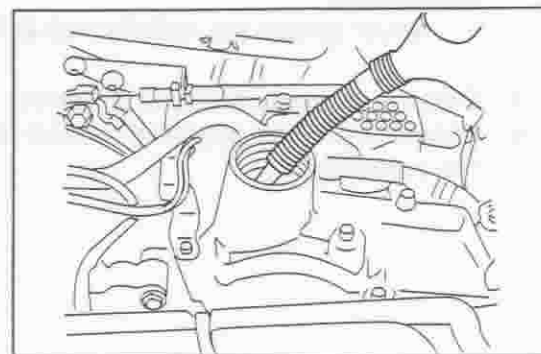

JMA00011-00007

12. Check the amount of oil that has been filled by means of the oil level gauge. Ensure that the oil level is between the two marks of the gauge.

NOTE:

- With a cloth or the like, wipe the forward end of the oil level gauge that will be dipped into the oil. Confirm the oil level by measuring the oil level two or three times.

13. Close the oil filler cap.

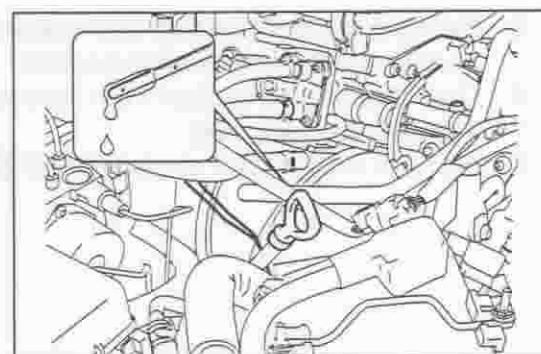

JMA00012-00008

FUEL LINE & CONNECTIONS

1. Perform the check every 40,000 kilometer running.
2. Check the fuel pipe and hose for damage, cracks or leakage.

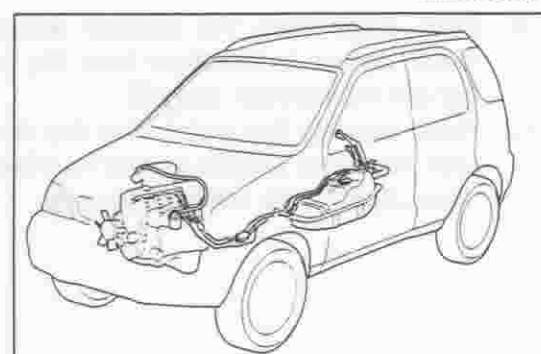

JMA00013-00009

3. Check the fuel pipe quick connector for loose connection. If the connection is contaminated with dust or mud, remove the contamination and clean the connection.

CAUTION:

- If the retainer of the quick connector is once removed from the pipe, it should not be used again.

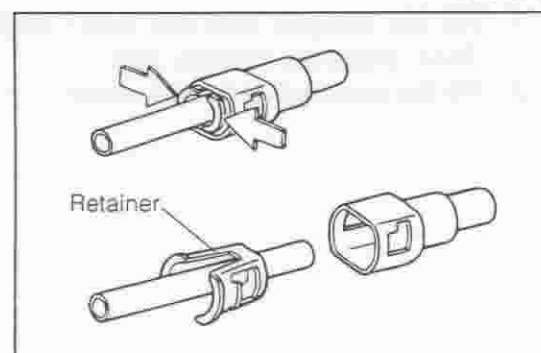

JMA00014-00010

ENGINE COOLANT

1. Change the engine coolant every two years.

WARNING:

- There is the possibility that you may burn yourself during this operation when the engine is hot.

2. Ensure that the engine coolant temperature has dropped nearly to the ambient temperature. Then, turn the radiator cap counter clockwise 45 degrees to release the radiator inner pressure.

WARNING:

- Never detach the radiator cap at this stage.

3. Place a suitable container under the radiator drain plug.
 4. Loosen the drain plug and receive the engine coolant with the container.

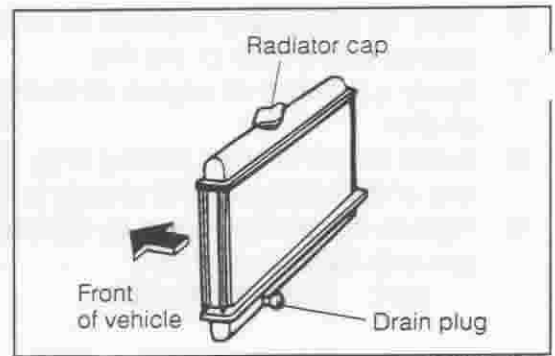

JMA00015-00011

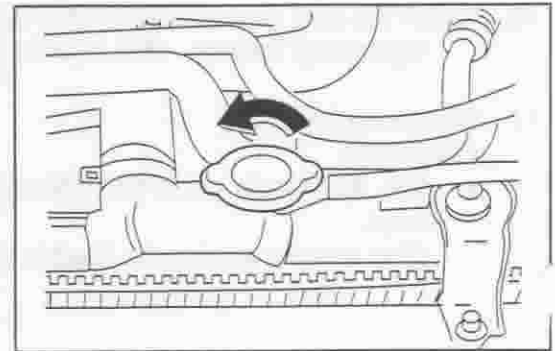

JMA00016-00012

5. Remove the radiator cap and loosen the bleeder plugs (A and B) to drain the engine coolant.
 6. Drain the engine coolant from the reservoir tank
 7. Tighten the drain plug
 8. Remove the bleeder plugs (A and B)

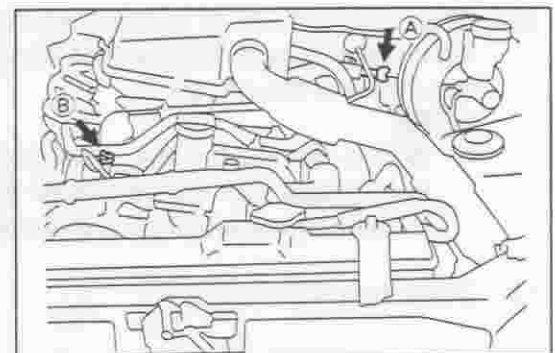

JMA00017-00013

9. Pour water from the radiator water filling port until the water begins to overflow from the bleeder plug (A). Then, tighten the bleeder plug (A).
 10. Keep pouring the water from the radiator water filling port until the water begins to overflow from the bleeder plug (B). Then, tighten the bleeder plug (B).

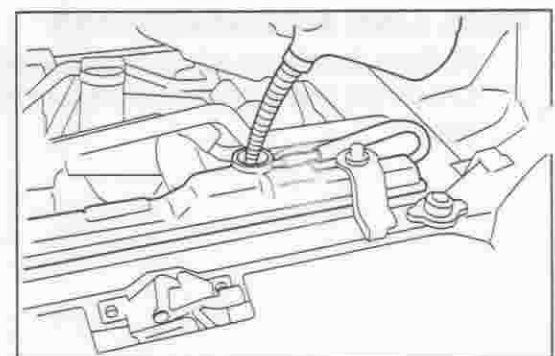

JMA00018-00014

11. Fill the radiator with the water until the water overflows. Then, close the radiator cap
 12. Fill the reservoir tank with water.

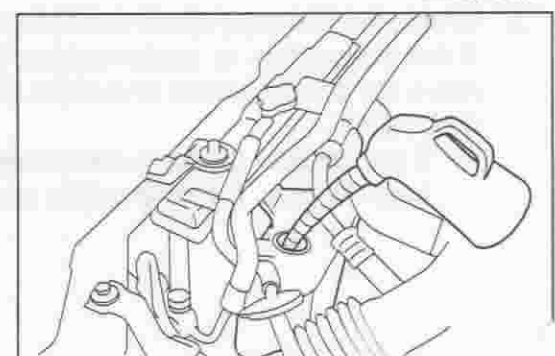

JMA00019-00015

NOTE:

- In the Step 9 and 10, if the water does not overflow from the bleeder plugs (A) and (B) or one of them, tighten the bleeder plugs after the water overflows from the radiator water filling port.

JMA00020-00000

13. Start the engine and keep the engine running at the engine revolution 2,000 rpm until the radiator fan operates twice.
Then turn off the engine.
14. When the engine is in a fully cold state after the engine has stopped, drain the water by following the Steps 2 to 7.
15. Repeat the operation described in Steps 8 through 14 three times to drain the old engine coolant fully.

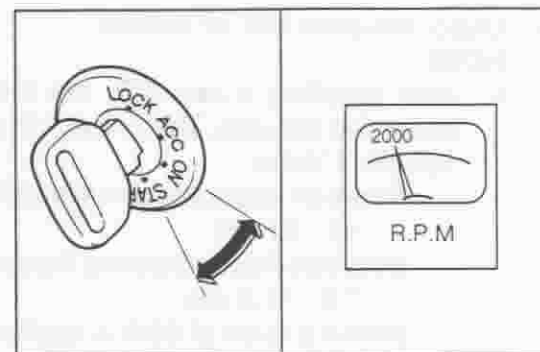

JMA00021-00016

16. Replace the O-ring of the radiator drain plug with a new one. Then, install the plug to the radiator.

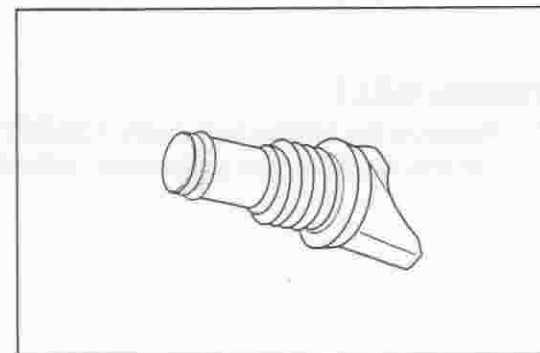

JMA00022-00017

17. Prepare the specified amounts of engine coolant in accordance with the instructions of the anti-freeze manufacturer.
18. Perform the operation described in Steps 8 through 13, using the engine coolant prepared in Step 17, instead of water.

Coolant Capacity:

Automatic Transmission: 5.55 liters

Manual Transmission: 5.65 liters

Reservoir Tank: 0.95 liters

JMA00023-00018

19. Replenish the coolant if the coolant level of the reservoir tank has dropped.

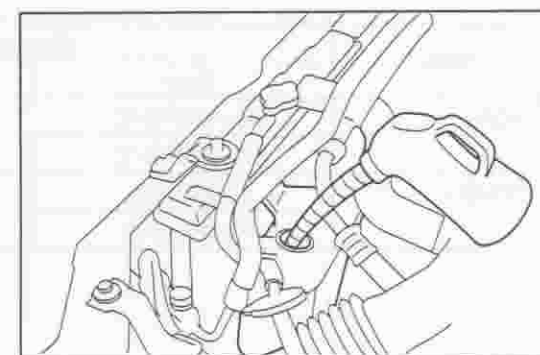

JMA00024-00019

DRIVE BELTS

1. Check the drive belt every year or 20,000 kilometer running, whichever comes first.
2. Check the rubber for deterioration, cracks or exposure of the core. Also check the drive belt for damage.
3. If the drive belt exhibits defects, replace it.

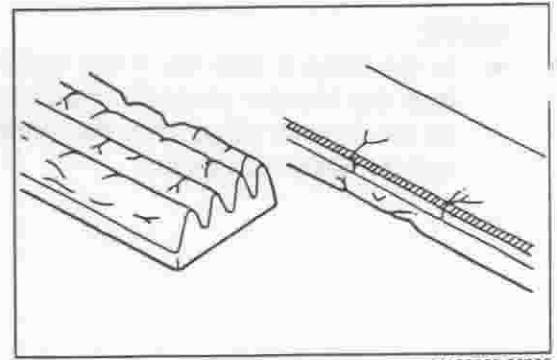

JMA00025-00020

4. Check the drive belt for tension.
- NOTE:**

- After installing a new belt, run the engine for at least about five minutes. Then, check the belt deflection.

Specified Value:

Between Alternator and Water Pump Pulley:
13 - 15 mm

Between Power Steering Pump and Water Pump:
7.5 - 11.5 mm

(When a force of 98 N is applied at midpoint of pulleys:)

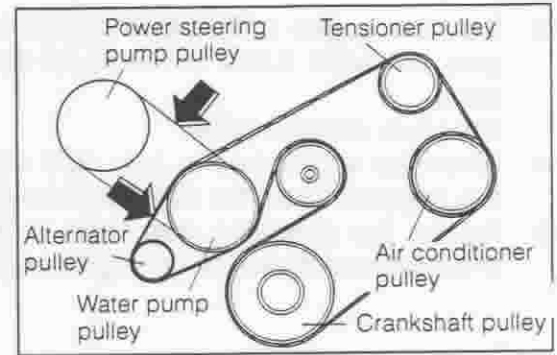

JMA00025-00021

TIMING BELT

1. Replace the timing belt every 100,000 kilometer running.
2. For the replacement procedure, refer to Section EM.

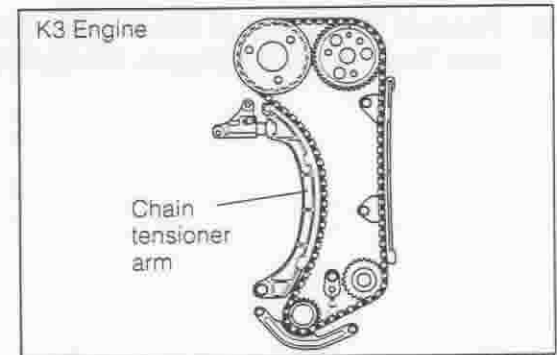

JMA00027-00022

SPARK PLUGS

1. Check and clean the spark plug every year or 20,000 kilometer running, whichever comes first.
2. Clean with a spark plug cleaner.
3. If the electrode gap of the spark plug does not conform to the specification, replace the spark plug.

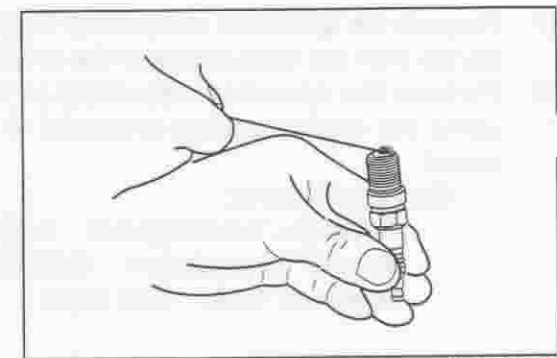

JMA00028-00023

Make	Europe		General	
	Type	Gap setting	Type	Gap setting
NGK	BKUR6ETB-10	0.9 - 1.0	BKR6EY-11	1.0 - 1.1
	BKUR5ETB-10		BKR5EY-11	
DENSO	K20BR-S10	0.9 - 1.0	K20R-U11	1.0 - 1.1
	K16BR-S10		K16R-U11	

BLOW-BY GAS RECIRCULATION HOSE

1. Perform checking every two years or 40,000 kilometer running, whichever comes first.
2. Check that each hose is connected securely.
3. Check each hose for damage and cracks.
4. Check the two hoses for restriction.
5. If the hose is defective, clean or replace it.

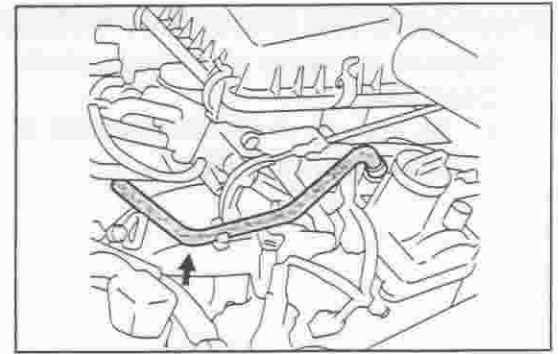

JMA00029-00024

CHARCOAL CANISTER

1. Perform checking every two years or 40,000 kilometer running, whichever comes first.
2. Take out the charcoal canister from the vehicle.

NOTE:

- In order to prevent wrong connection of the pipes during the installation, put a tag on the connection of each pipe before disconnecting the pipes.

3. Visually inspect the charcoal canister case for cracks or damage. If any damage is found, replace the charcoal canister with a new one.

4. Check the charcoal canister for air leakage. Ensure that no air leakage exceeding 0.3 ml/min. is present when applying compressed air of 29.4 kPa (0.3 kgf/cm²) into the fuel tank side pipe (B) with the throttle body side (A) and atmosphere side (C) pipes plugged.

If air leakage exceeding the above-specified value is present, replace the charcoal canister with a new one.

5. Ensure that no air continuity exists when you blow into the purge side (A) pipe of the charcoal canister. If air continuity exists, replace the charcoal canister with a new one.

6. Check of charcoal canister for restriction
 - (1) Ensure that air continuity exists to the atmosphere side (C) pipe, when you blow into the fuel tank side pipe (B) while the purge side (A) pipe is plugged.

If no air continuity exists, replace the charcoal canister with a new one.

- (2) Ensure that air continuity exists when applying a negative pressure to the purge side pipe (A) by a MityVac. If no air continuity exists, replace the charcoal canister with a new one.

7. Cleaning of charcoal canister
Clean the charcoal canister by blowing compressed air of 294.2 kPa (3.0 kg/cm²) into the fuel tank side pipe (B) while holding the purge side of the canister pipes (A) closed.

CAUTION:

- Never attempt to wash the charcoal canister. No activated carbon should come out during the test. If activated carbon comes out, replace the charcoal canister.

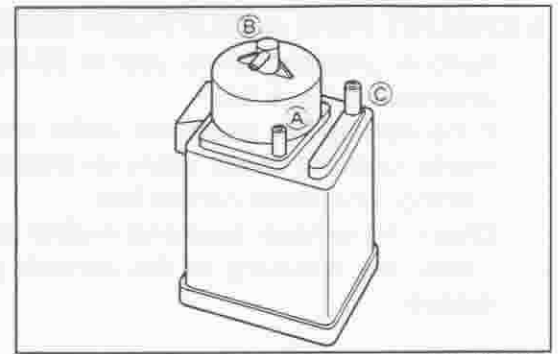

JMA00030-00025

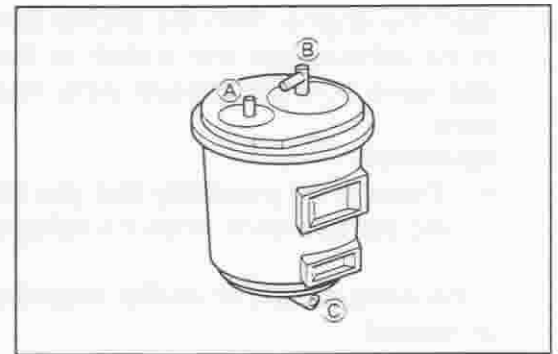

JMA00031-00026

JMA00032-00000

JMA00033-00000

EVAPORATIVE EMISSION HOSES

1. Replace the hoses every eight years.

CAUTION:

- Be sure to make connections at the piping with new hose bands and clips.

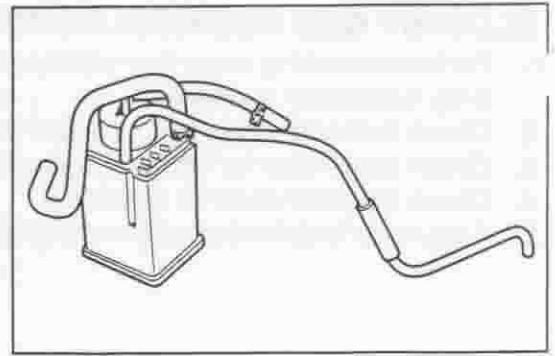

JMA00034-00027

EXHAUST PIPE & MUFFLER MOUNTING

1. Perform checking every year or 20,000 kilometer running, whichever comes first.
2. If the vehicle has been run under severe driving environments, perform check every six months or 5,000 kilometer running, whichever comes first.
3. Check the exhaust pipe and muffler for damage.
4. Check the mounting of the exhaust pipe and muffler for defects.

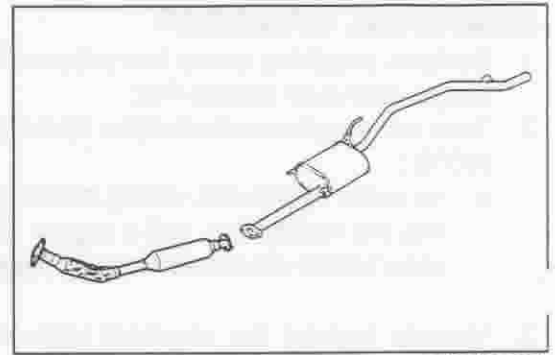

JMA00035-00028

5. Start the engine. With the engine idling, restrict the outlet of the exhaust gas with a cloth or the like. Ensure that no gas leaks from the exhaust pipe, muffler or their connections.

WARNING:

- There is the possibility that you may burn yourself during this operation when the exhaust pipe is hot.

6. If the exhaust pipe or muffler mounting is defective, repair or replace.

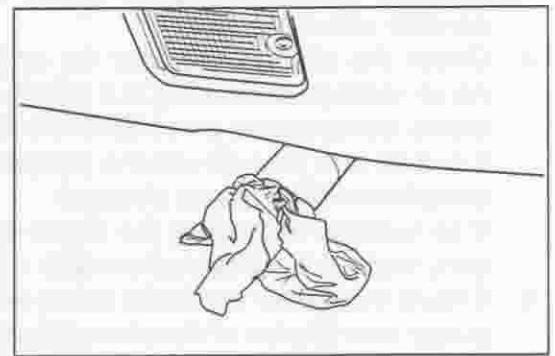

JMA00036-00029

CLUTCH

1. Perform checking every year or 20,000 kilometer running, whichever comes first.
2. Push the clutch pedal downward. Measure the distance between the pedal initial position and a point where a resistance begins to be felt.

Specified Value: 3 - 20 mm

3. If the distance does not conform to the specification, perform the adjustment. For details of the adjustment, refer to Section CL.

4. Install an engine tachometer.
5. Pull the parking brake lever. Place the shift position of the transmission in the neutral position. Start the engine.
6. Depress the clutch pedal fully. Place the shift position of the transmission in the first gear position. Disengage the clutch pedal gradually. Measure the distance between the fully-depressed clutch pedal and the pedal just before the engine evolution speed begins to drop.

Specified Value: 25 mm or more

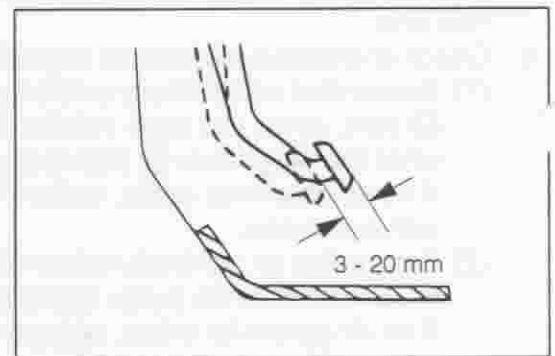

JMA00037-00030

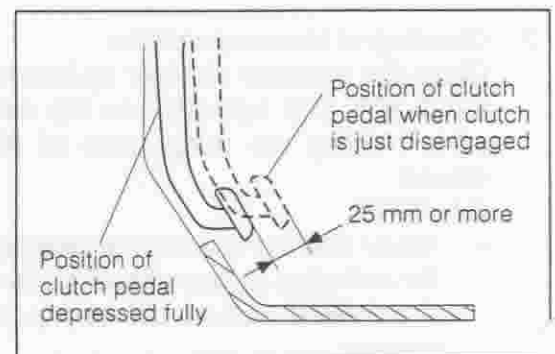

JMA00038-00031

AUTOMATIC TRANSMISSION OIL COOLER HOSES

1. Perform checking every 40,000 kilometer running.
2. Check each piping for loose connection.
3. Check each piping for damage and cracks.
4. Replace the hose, as required.

CAUTION:

- Be sure to make connections at the piping with new hose bands and clips.

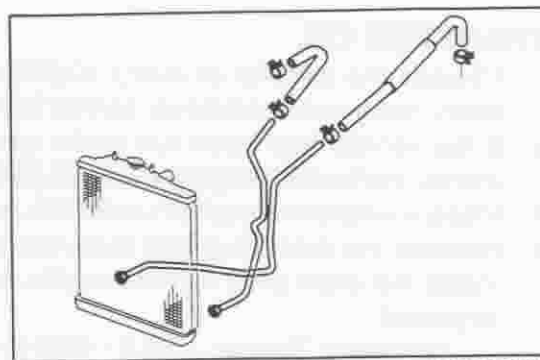

JMA00039-00032

AUTOMATIC TRANSMISSION FLUID

1. Change the automatic transmission fluid every 80,000 kilometer running.
2. If the vehicle has been run under severe driving environments, perform changing every 50,000 kilometer running.
3. Place a suitable container under the drain plug of the automatic transmission.
4. Remove the drain plug and drain the fluid.
5. Install the drain plug to the transmission with a new gasket interposed.

Tightening Torque: 19.6 - 29.4 N·m

6. Fill the specified fluid from the filler tube.
Grade: ATF DEXRON® II or III
Filling Amount: 1.5 liters

NOTE:

- For details of the operation, refer to Section AT.

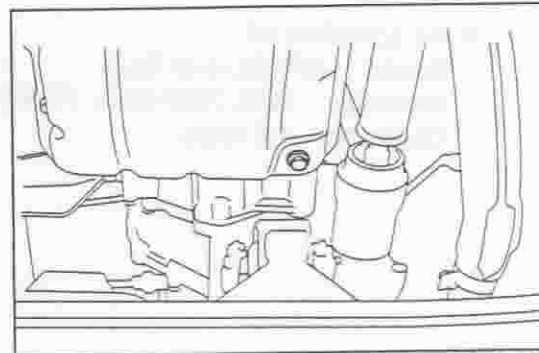

JMA00040-00033

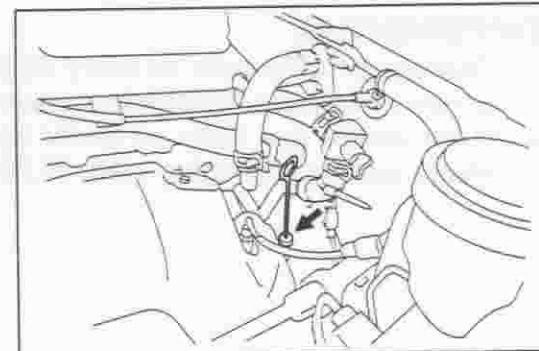

JMA00041-00034

MANUAL TRANSMISSION OIL

1. Change the manual transmission oil every two years or 40,000 kilometer running, whichever comes first.
2. If the vehicle has been run under severe driving environments, change the manual transmission oil every 25,000 kilometer running.
3. Place a suitable container under the drain plug of the transmission.
4. Remove the drain plug and drain the oil.
5. Install the drain plug to the transmission with a new gasket interposed.

Tightening Torque: 29.4 - 49.0 N·m

6. Fill the specified oil from the filler plug hole.
Grade: API GL-3 or GL-4
Viscosity: SAE 75W-85 or 75W-90
Filling Amount: 2.1 - 2.25 liters

7. Install the filler plug to the transmission with a new gasket interposed.

Tightening Torque: 29.4 - 49.0 N·m

NOTE:

- For details of the operation, refer to Section MT.

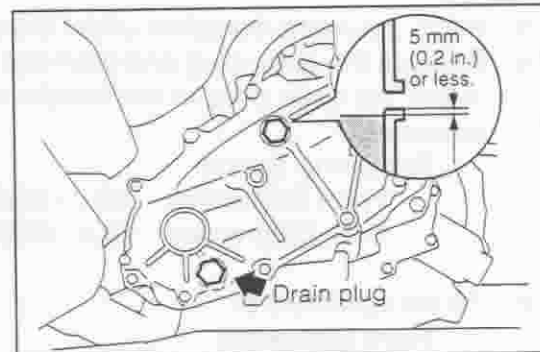

JMA00042-00035

JMA00043-00036

TRANSFER OIL

1. Change the transfer oil every 40,000 kilometer running or every two years, whichever comes first.
2. If the vehicle has been run under severe driving environments, perform changing every 25,000 kilometer running.
3. Place a suitable container under the drain plug.
4. Remove the drain plug and drain the oil
5. Install the drain plug to the transfer with a new gasket interposed.

Tightening Torque: 29.4 - 49.0 N·m

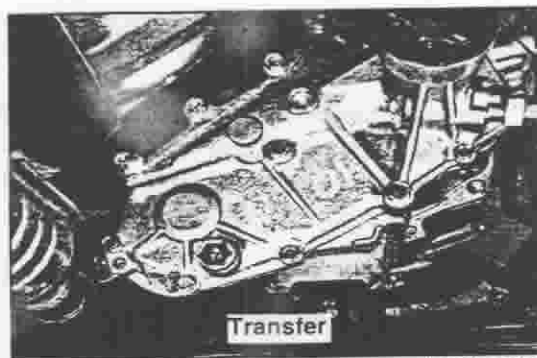

JMA00044-00037

6. Fill the specified oil
Grade: API GL-3 or GL-4
Viscosity: SAE 75W-85 or 75W-90
Capacity: 1.6 liters

DIFFERENTIAL

1. Change the differential oil every 40,000 kilometer running or every two years, whichever comes first.
2. If the vehicle has been run under severe driving environments, perform changing every 25,000 kilometer running.

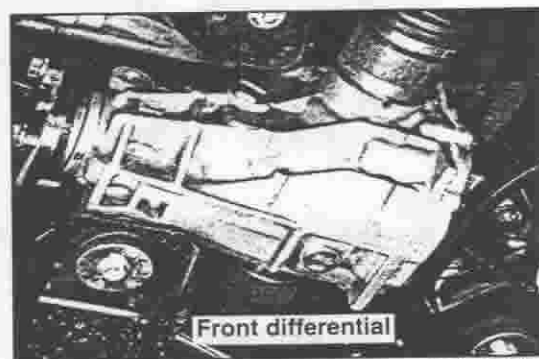

JMA00045-00038

3. Place a suitable container under the drain plug.
4. Remove the drain plug and drain the oil.
5. Install the drain plug to the transfer with a new gasket interposed.

Tightening Torque:

Front Differential: 39.2 - 58.8 N·m

Rear Differential: 53.9 - 68.0 N·m

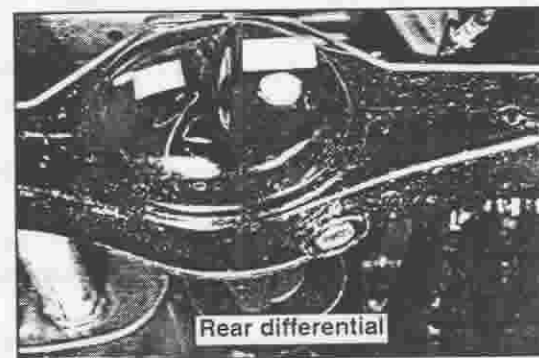

JMA00046-00039

6. Fill the specified oil
Front Differential
Grade: API GL-5
Viscosity: SAE 80W-90
Capacity: 0.7 liter
Rear Differential (Conventional)
Grade: API GL-5
Viscosity: SAE 80W-90
Capacity: 1.55 liters
Rear Differential (LSD)
Grade: API GL-5
Viscosity: SAE 80W-90 LSD
Capacity: 1.55 liters

PROPELLER SHAFT

1. Perform checking every year or 20,000 kilometer running, whichever comes first.
2. Ensure that no looseness exists on the attaching bolts of the universal joint flange yokes which were connected to the front, rear differential and propeller shaft, using a torque wrench.

Tightening Torque: 51.0 - 69.6 N·m (5.2 - 7.1 kgf·m)

If any looseness exists, retighten the attaching bolts as required.

(Refer to the PR section.)

3. Ensure that no excessive play exists on the universal joints.

If any excessive play exists, repair the universal joint by replacing the spider kit or replace the propeller shaft with a new one.

(Refer to the PR section.)

4. Ensure that no excessive play exists between the propeller shaft and the transfer output shaft.

If excessive play is found, replace the front propeller shaft and/or transfer output shaft as required.

(Refer to the PR and/or TR section.)

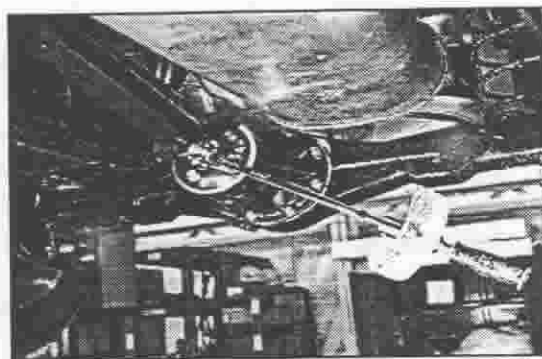

JMA00047-00040

DRIVE SHAFT BOOT

1. Perform checking every year or 20,000 kilometer running, whichever comes first.
2. Check the boot for damage and cracks.
3. If the boot exhibits defects, replace it. Seal new grease.

NOTE:

- For the operation procedure, refer to Section FS.

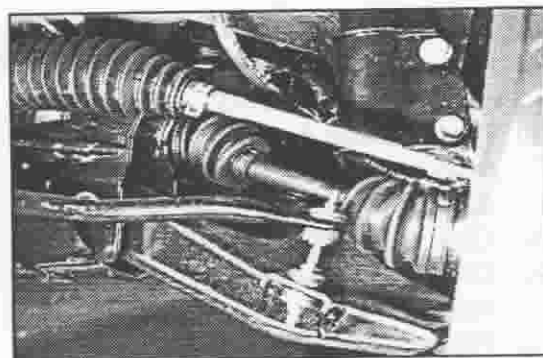

JMA00048-00041

SHOCK ABSORBERS

1. Perform checking every year or 20,000 kilometer running, whichever comes first.
2. Check the shock absorber for oil leakage and damage.
3. Rock the vehicle with your hands. Check to see if rocking finishes within a short length of time.
4. During this rocking, check that there is no abnormal sound.

NOTE:

- For details, see Section FS and Section RS.

5. Repair or replace any defective parts.

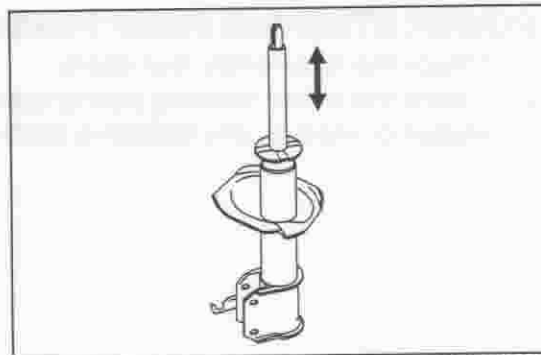

JMA00049-00042

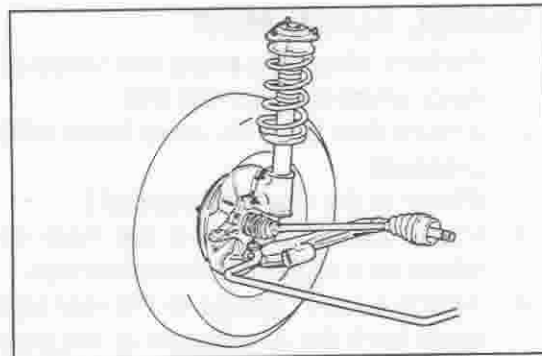

JMA00050-00043

WHEEL BEARINGS

1. Perform checking every two years or 40,000 kilometer running, whichever comes first.
2. Jack up the vehicle. Hold the tire by your hands and rock it in a fore-and-aft direction. If you feel excessive play at your hands, it shows that the bearing is defective. Replace the bearing.

NOTE:

- For details, see Section FS and Section RS.

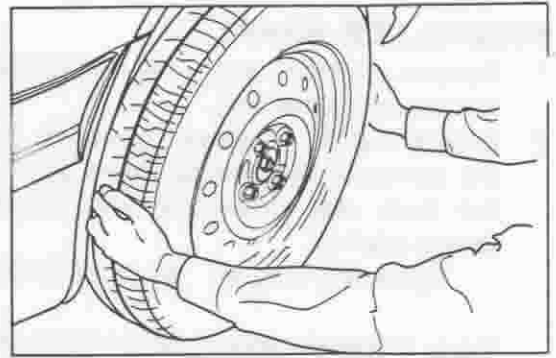

JMA00051-00044

STEERING LINKAGE

1. Perform checking every year or 20,000 kilometer running, whichever comes first.
2. If the vehicle has been run under severe driving environments, perform checking every six months or every 5,000 kilometer running, whichever comes first.
3. Check the dust cover of the tie rod end ball joint for cracks and damage.
4. Check the steering rack boot for cracks and damage.
5. Repair or replace any defective parts.

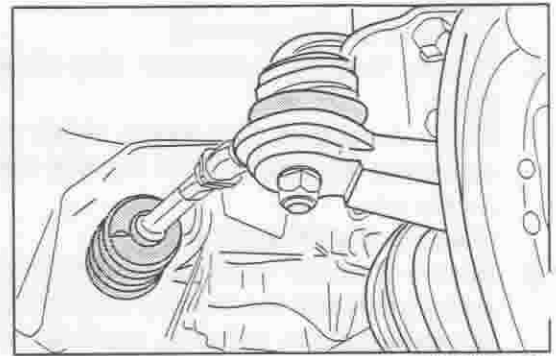

JMA00052-00045

STEERING GEAR BOX

1. Perform checking every year or 20,000 kilometer running, whichever comes first.
2. If the vehicle has been run under severe driving environments, perform checking every six months or every 5,000 kilometer running, whichever comes first.
3. Check the steering shaft joint for looseness.
4. Check the bolt of the gear box installation bracket for looseness.
5. Replace any defective parts.

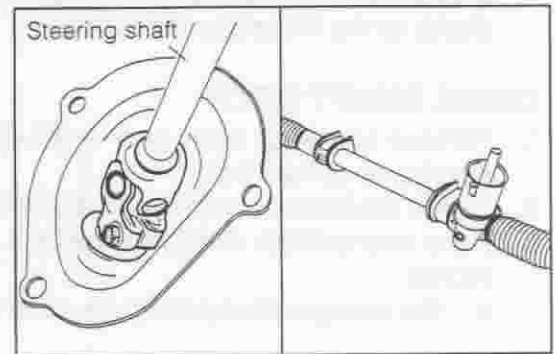

JMA00053-00046

POWER STEERING PUMP FLUID HOSE

1. Check the hose every four years.
2. Check the power steering piping system for fluid leakage.
3. Repair or replace any defective parts.

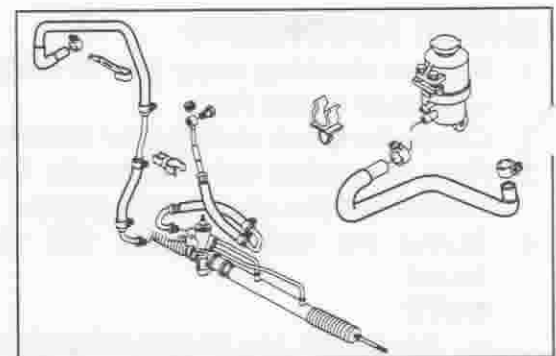

JMA00054-00047

WHEEL ALIGNMENT

1. Perform checking every two years or 40,000 kilometer running, whichever comes first.
2. Ensure that the tires have been inflated with the specified pressure.
(Refer to the Owner's manual.)
3. Place the vehicle on a flat floor and place the steering wheel to a straight ahead direction.
4. Attach a toe-in gauge to the rear side at the center point of each front tire at a height of tire center and put a mark on each tire.

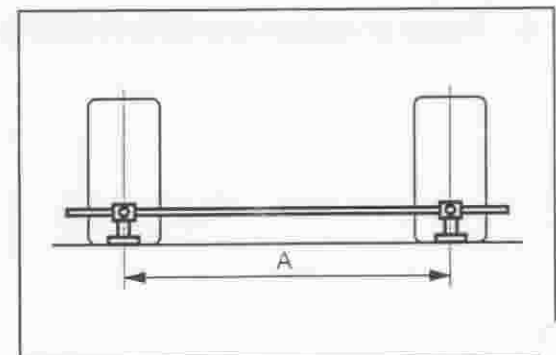

JMA00055-00048

5. Move the vehicle forward in a straight ahead direction gradually until the marks put on the tires come to the front side.
6. Attach the toe-in gauge to the front side, at the center point of each front tire. Determine the difference in the mark-to-mark distance between the first measurement and the second measurement. This difference constitutes the toe-in.
7. Ensure that the measured difference is within the specified value.

Specified Value: 0 ± 2 mm

If the measured difference (toe-in) fails to meet with the specification, adjust the toe-in to the specified value.
(Refer to the FS section.)

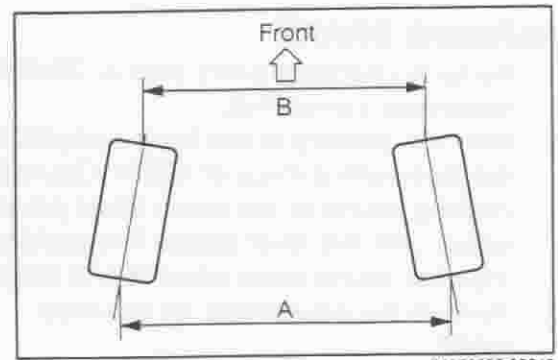

JMA00056-00049

BRAKE PEDAL

1. Perform checking every year or 20,000 kilometer running, whichever comes first.
2. Ensure that the ignition switch is turned OFF.
3. Depress the brake pedal more than five times to release the vacuum saved in the brake booster.
4. Ensure that the specified free play exists on the brake pedal by pushing the brake pedal lightly by hand.

Free Play: 0.5 - 2.0 mm

If the free play is not within the specified value, adjust the free play by adjusting the push rod length.
(Refer to the BR section.)

5. Place chocks at the wheels.
6. Place the transmission in the neutral position.
7. Start the engine.
8. Depress the brake pedal with an applying force of 300 N (30 kgf).

CAUTION:

- At this stage the hand brake should not be applied.

9. Measure the distance between the position where the brake pedal pad upper surface is depressed and the floor panel as shown.

Ensure that the reserve travel meets with the specification.

Reserve Travel: 108.3 mm or more

If the reserve travel fails to meet with the specification, check/adjust or repair the brake shoe clearance as necessary.

(Refer to the BR section.)

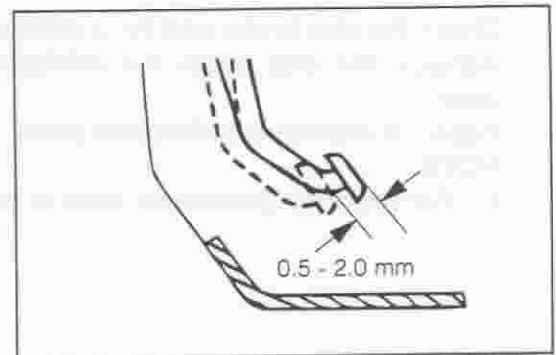

JMA00057-00050

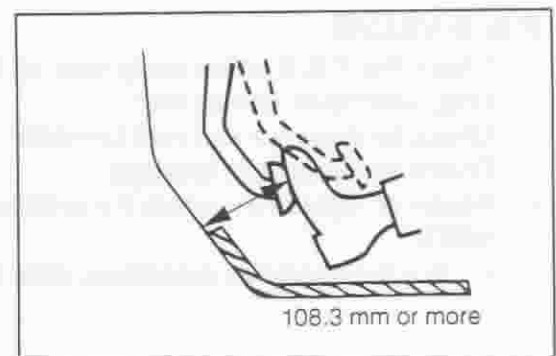

JMA00058-00051

PARKING BRAKE

1. Perform checking every year or 20,000 kilometer running, whichever comes first.
2. With the parking brake lever completely released, pull up the lever with a force of 196 N. Count how many times the clicking sound of the notch takes place from the initial position, until the lever stops. The parking brake is normal if the click sound takes place five to seven times.
3. Perform the adjustment, as required.

NOTE:

- For the adjustment procedure, refer to Section BR.

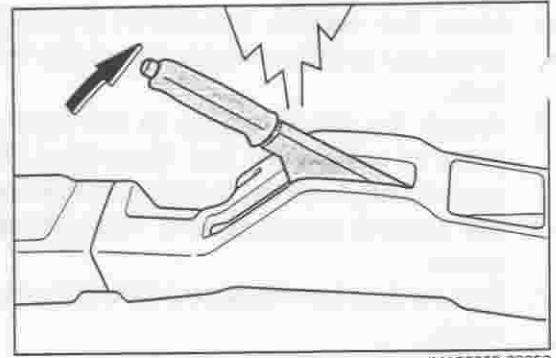

JMA00059-00052

FRONT BRAKE DISC & DISC PAD

1. Perform checking every year or 20,000 kilometer running, whichever comes first.
2. If the vehicle has been run under severe driving environments, perform the checking every six months or 5,000 kilometer running.
3. Check the thickness of the disc brake pad.
Specified Value: 1 mm or more

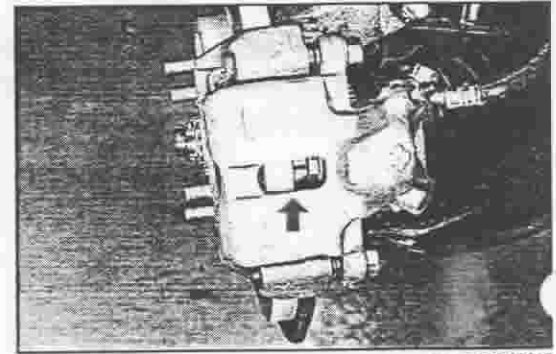

JMA00060-00053

4. Check the disc brake pad for uneven wear.
5. Replace the disc brake if it exhibits damage or severe wear.
6. Repair or replace any defective parts.

NOTE:

- For operation procedure, refer to Section BR.

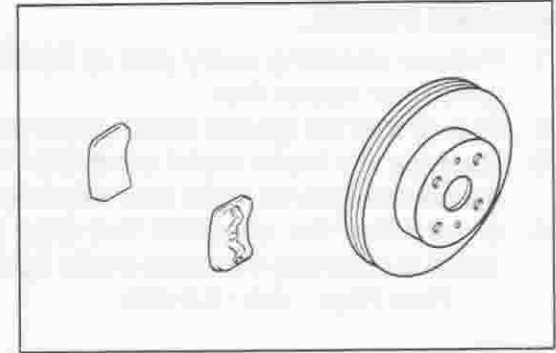

JMA00061-00054

BRAKE HOSES & TUBES

1. Check the brake hose and tube every year or 20,000 kilometer running, whichever comes first.
2. Check the hose for cracks and other defects.
3. Check the tube for damage and rust formation.
4. Check for brake fluid leakage.

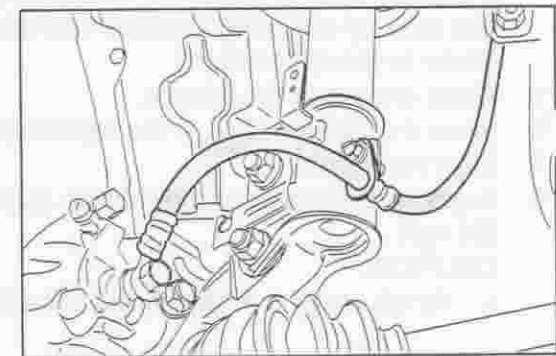

JMA00062-00055

P & B VALVE

1. Check the P & B valve every year or 20,000 kilometer running, whichever comes first.
2. Check for damage and rust formation.
3. Check for brake fluid leakage.
4. Repair or replace the valve if it is defective.

NOTE:

- For the operation procedure, refer to Section BR.

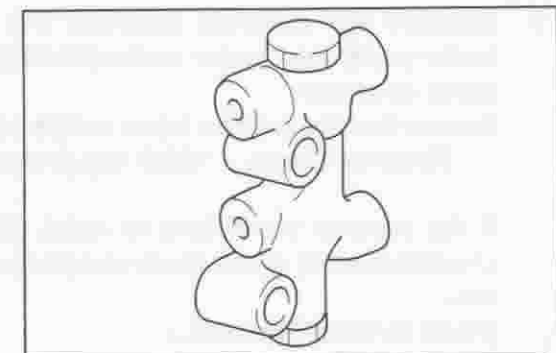

JMA00063-00056

BRAKE FLUID

1. Change the brake fluid every two years.
2. Perform the air bleeding of the brake hydraulic pipe, starting from the wheel cylinder which is the farthest from the master cylinder.

NOTE:

- For the operation procedure, refer to Section BR.

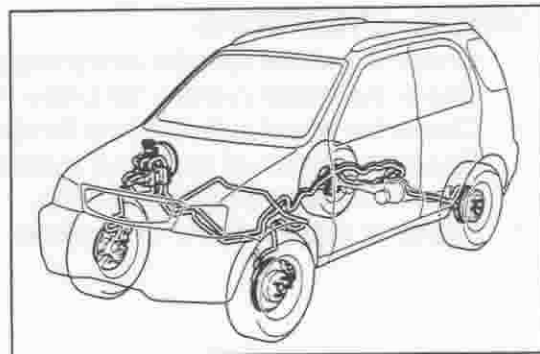

JMA00064-00057

BRAKE DRUM & LINING

1. Check the brake drum and lining every year or 20,000 kilometer running, whichever comes first.
2. If the vehicle has been run under severe driving environments, perform the checking every six months or 5,000 kilometer running, whichever comes first.
3. Remove the brake drum and check the brake lining for uneven wear.
4. Check the thickness of the brake lining.
Specified Value: 1 mm or more

5. Replace the brake drum if it exhibits damage or severe wear.
6. If there are defects, repair or replace.

NOTE:

- For the operation procedure, refer to Section BR.

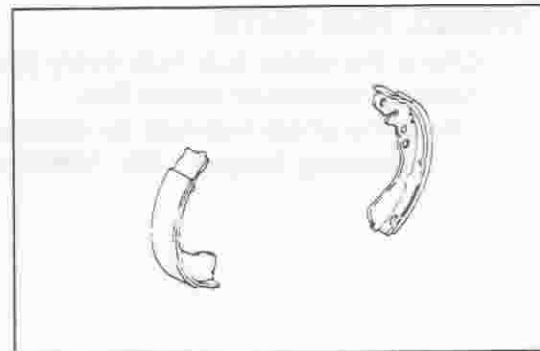

JMA00065-00058

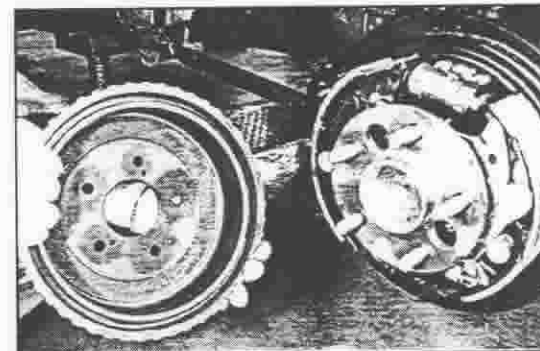

JMA00066-00059

BRAKE BOOSTER VACUUM HOSES

1. Check the brake booster vacuum hose every four years.
2. Check the vacuum hose for damage and cracks.
3. Check the vacuum hose for restriction and leakage, using a MityVac.
4. If there are defects, clean or replace.

NOTE:

- When replacing the vacuum hose, be sure to use new hose bands.

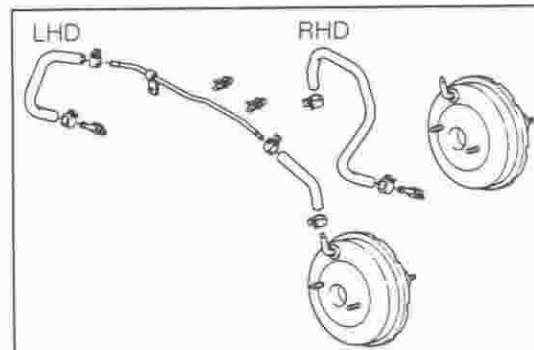

JMA00067-00060

MASTER CYLINDER

1. Check the master cylinder every two years.
2. Remove the master cylinder from the booster. Check the master cylinder for brake fluid leakage.
3. Check the piston of the master cylinder for wear. Check the cup for damage and deterioration.
4. Repair or replace the master cylinder if it is defective.

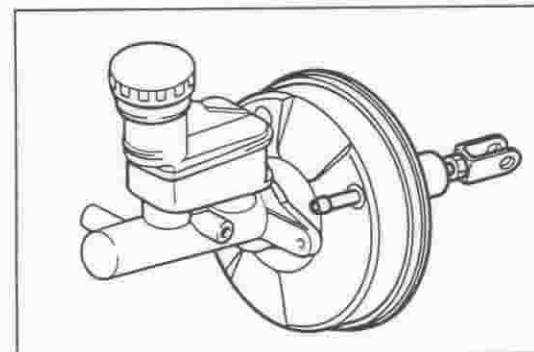

JMA00068-00061

WHEEL CYLINDERS

1. Check the wheel cylinder every two years.
2. Check the wheel cylinder for brake fluid leakage.
3. Check the wheel cylinder boot for damage.
4. Check the piston of the wheel cylinder for wear. Check the cup for damage and deterioration.
5. Repair or replace the wheel cylinder if it is defective.

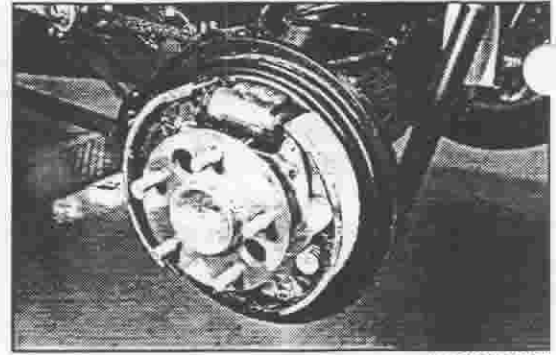

JMA00069-00062

WHEEL HUB NUTS

1. Check the wheel hub nuts every year or 20,000 kilometer running, whichever comes first.
2. Check the wheel hub nuts for looseness.
Tightening Torque: 89 - 118 N·m

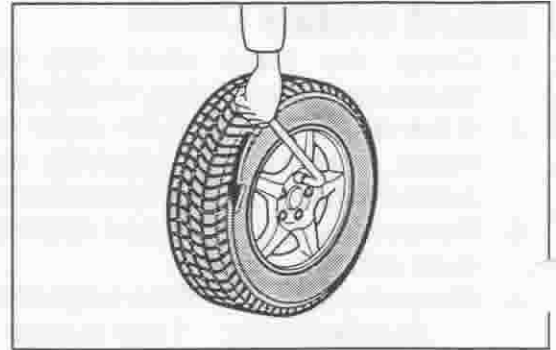

JMA00070-00063