

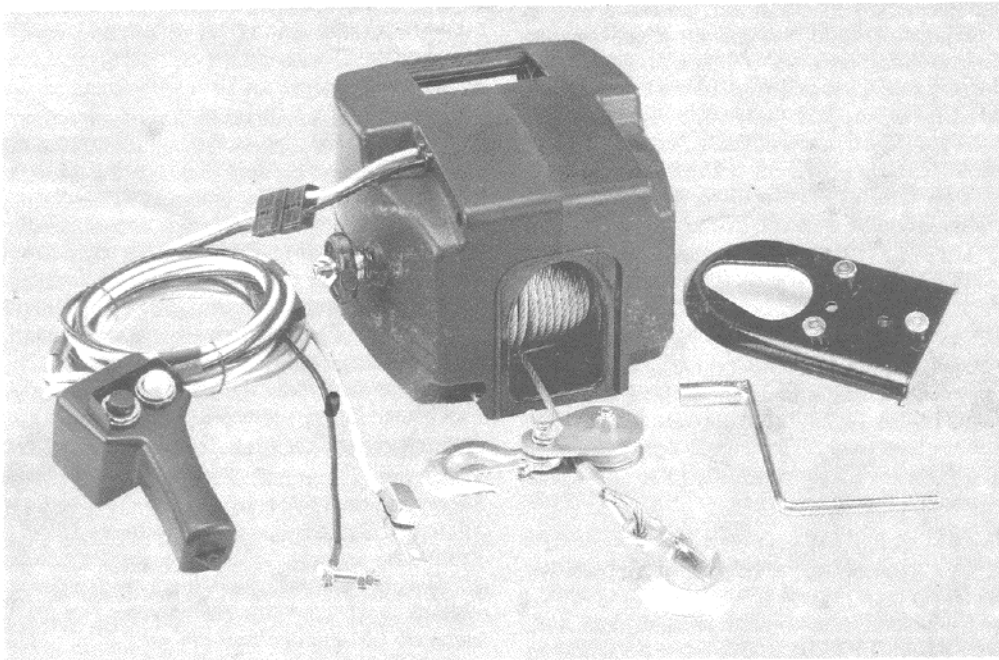

# Instruction Manual



## Model

**U0701 – 12 VDC**

**U0702 – 24 VDC**

## Electrical Winch

 **SHINN FU EUROPE B.V**  
Roosendaf, the Netherlands

## Owner's Responsibilities

1. The owner and/or the operator shall have an understanding of these operating instructions and the following warnings before operating the electrical winch. Failure to follow these warnings may result in loss of load, damage to the winch, property damage, personal or fatal injury.
2. Warning information shall be emphasized and understood. If the user is not fluent in English, instructions and warnings shall be read to and discussed with the user in the user's native language by the owner to make sure that the user comprehends the contents.
3. The owner shall retain this manual for further reference to important warnings, installation, and operating and maintenance instructions.

## Description

The electrical winch is designed for a variety of pulling, positioning and unloading jobs, and is featured with Power-in Power-out as well as the Free Wheel cable function. It is designed for intermittent duty and has a specific duty cycle rating (see SPECIFICATIONS). The electrical winch is portable, and is 12/24 volt DC powered, but may not be used for lifting, transporting people or for handling loads which are suspended over or in close proximity to people. The winch can be mounted on any flat surface capable of sustaining rated capacity loads.

*Never connect to other than 12/24-volt DC systems rated at 55 a/H minimum. Use on other than 12/24-volt DC systems or systems with insufficient current will damage power supply and the winch, and can cause personal injury to the operator and bystanders. Never connect directly to or attempt to power by using a battery charger.*

## Warning

1. Never use as a lifting device or as a hoist for vertical lifting (see figure 1).

Figure 1

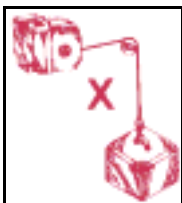

2. Never winch a vehicle with passengers in it, leaning against it, or pushing it from behind (see figure 2).

Figure 2



3. All performance ratings are based on the first layer of the cable on the spool with no less than 3 full turns. Rated capacity pulls are not possible with full spool condition.
4. Rolling load capacity is based on the flat surface, which is smooth and level.
5. Never overload the winch, and get the winch wet. In self-recovery conditions, use common sense.
6. Winching a load from deep, gumbo mud or snow will greatly reduce the effectiveness of the winch. Use every precaution to help lessen the severity of a cable break.

7. Always use leather gloves or a heavy rag when handling the cable (see Figure 3).

Figure 3

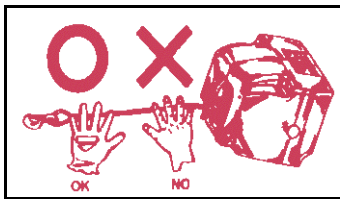

8. Always keep hands and body away from the cable and the Gable spool during operation.

9. For best winching results, a vehicle should be running, transmission set in neutral, emergency brake set and wheels securely chocked (see Figure 4).

Figure 4

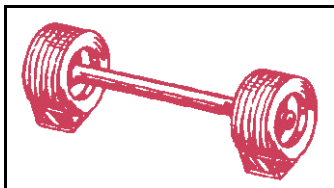

10. To prevent overheating and possibly a fire, always connect the circuit breaker to the power loom provided with the winch.

11. When not in use, disconnect the power cord from the winch to prevent accidental start-up.

12. When winching a heavy load, place a blanket or jacket on the cable 1 to 2 meters ahead of the cable hook to help lessen the severity of a cable break (see Figure 5).

Figure 5

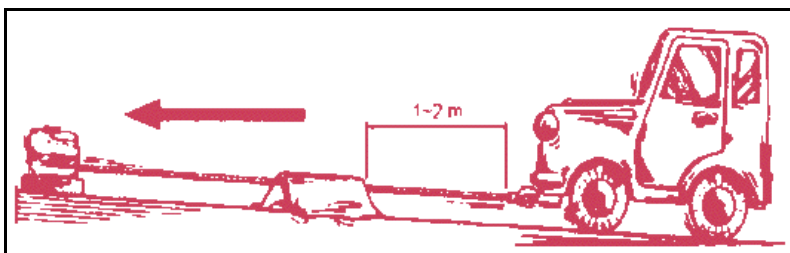

13. The ambient lighting area where the winch is in use shall have a sufficient intensity to allow safe working with the winch.

14. It is the owner's responsibility to keep warning decals legible and intact. Replacement decals may be obtained from the factory.

## Installation

### Handling

Please refer to figure 6 for a correct way to carry the winch.

Figure 6

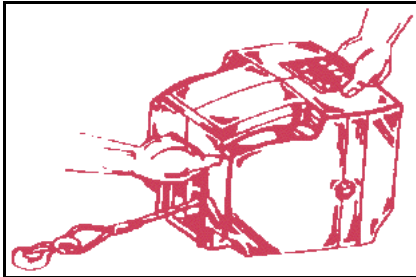

### Wiring

1. Locate a suitable place to install the winch (see Mounting).
2. Place the power plug near the location to install the winch. Be sure to leave enough wire length to insert the plug into the winch.
3. Run the wires under or through the vehicle to the battery. If drilling holes to feed the wires is necessary, be sure the wires are well protected by rubber grommets (not supplied, see Figure 7).

Figure 7

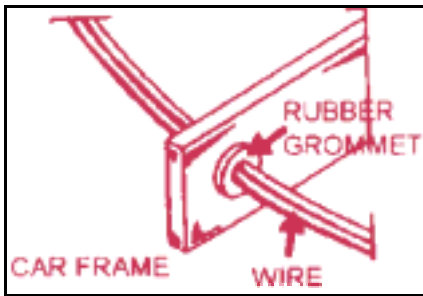

4. Use electric tape or nylon ties (not supplied) to secure the wires to the frame of the vehicle about every 30 cm.
5. Attach the black wire to the metal frame (sandpaper both sides of the metal frame where the wire is attached). Use a 5/16" bolt, nut and lock washer (see Figure 8) to attach the wire firmly to the frame.

Figure 8

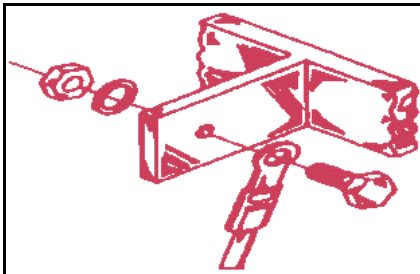

6. Attach the red wire firmly to the circuit breaker marked AUX. and the buss bar (copper plate) to the other end of the circuit breaker marked BAT (see Figure 9).

Figure 9

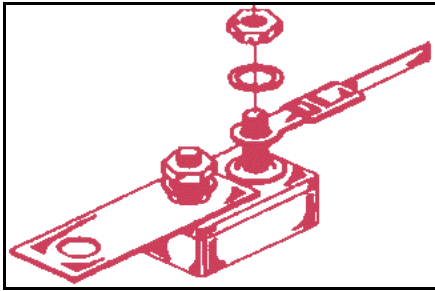

7. Connect the circuit breaker to the battery (see Figure 10).

Figure 10

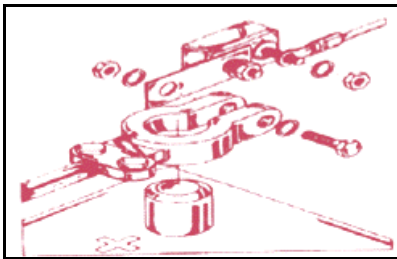

8. Check all Wires Be sure they are secured and wired correctly.

### **Mounting Mounting on the vehicle with a trailer hitch**

1. Install the plate stud onto the adapter plate (see Figure 11)

Figure 11

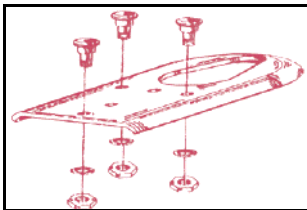

2. Use a M10 screw (not supplied) to firmly attach the adapter plate to the winch.

3. When ready to use, hang the winch on the trailer hitch.

## Truck Bed Mount

1. Use two steel plates and drill eight 10 mm holes on each plate (see Figure 12).

Figure 12

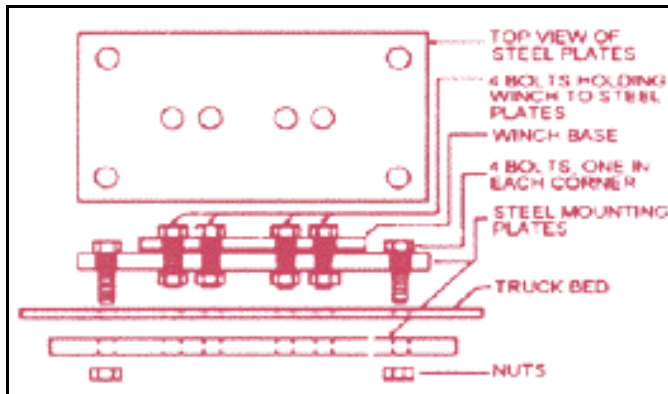

2. Use M10 screws and nuts to fasten the plates and the winch.

*Most truck beds are not designed to support the pulling capacity of the winch. It should be reinforced with steel plates capable of withstanding the rated capacity of the Winch.*

## Haybaler Mount

Follow the instructions included With the haybaler. Make sure that the winch is bolted to a location able to support the winch under full load conditions.

## Inspection

Visual inspection shall be made before each use of the Winch, checking for any sign of fraying or kinking which may cause the cable to break and result in property damage and/or personal injury. Be sure to have the winch inspected by a local service center if the cable becomes kinked or frayed, or should abnormal shock occur.

## Operation

### Precautions

1. The continual operating time shall **never** exceed 4 minutes.
2. Be sure to turn the clutch knob clockwise until tight when in use and turn it counterclockwise until loose after use (see Figure 13). This could prevent the clutch spring from becoming fatigued due to continual compression.

Figure 13



3. Put the car in neutral with the **Emergency Brake On** (never winch with the automatic transmission of the vehicle in **PARK**. This could damage the transmission). Block the wheels with rocks or wheel chocks (see Figure 4 on page 3).
4. In order to pull out the cable, turn the clutch knob counterclockwise, then pull out the amount of the cable needed. Always leave at least 3 turns of the cable on the drum. This will prevent the cable from being pulled out of the drum under load.
5. Hook the object to be pulled. Do not wrap the cable around load and hook to itself (see Figure 14). Always use a strap to insure that the cable does not fray or kink.

Figure 14

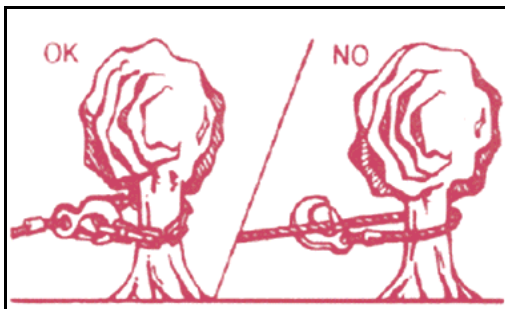

6. Keep hands and cloth away from the drum area and the cable. Plug the remote control plug onto the winch first, then plug the power plug.
7. Inspect the entire cable. Make sure it is not fraying or kinking, short, tight, twisting or curling.
8. When in use, turn the clutch knob clockwise until tight (see Figure 13). **DO NOT** over tighten or the clutch will be damaged.
9. Stay as far as away from the winch and the cable.
10. In order to prevent the hook and/or pulley block assembly from being trapped inside the winch, the spooling process shall be interrupted when the **YELLOW** section of the cable reaches the winch housing (see Figure 15 on next page).
11. In order to prevent the entire cable from being pulled out of the winch, the unspooling process shall be interrupted when the **RED** section of the cable is observed (see Figure 15 on next page).

Figure 15

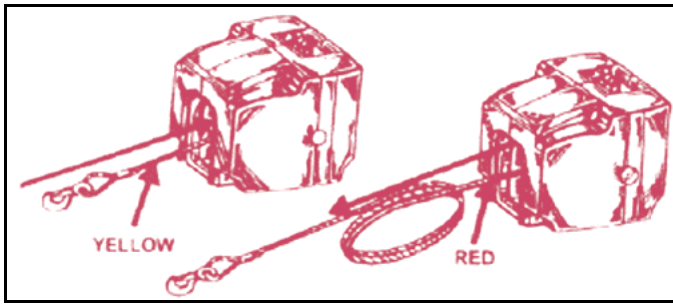

12. Never disconnect the electrical cord plug when winching a load.

### Power-in & Power-out Operation

1. Turn the clutch knob clockwise until tight, and power the winch to either spool or unspool the cable. This feature has its own special precautions. Use extreme caution as well as common sense when in use.

*Do not subject the winch to a series of repeated and quick direction changes as this will create a shock load which will damage the winch and can cause serious injury to the operator and bystanders*

2. To use the power-in & power-out functions, simply push the buttons on the remote control unit marked "CABLE IN" or "CABLE OUT" depending on the direction desired (see Figure 16.1 & 16.2). Never push both buttons at the same time. This is likely to cause the circuit breaker to blow, damage to the winch, and may result in serious personal injury,

Figure 16.1

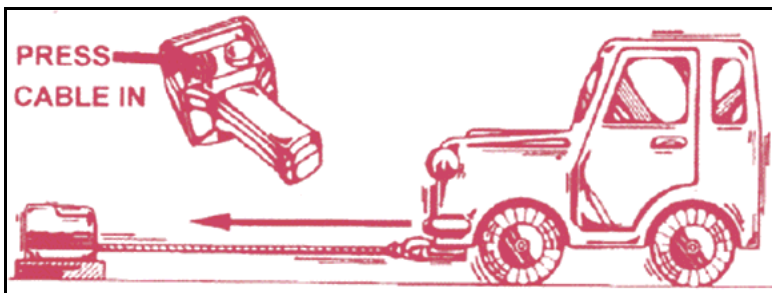
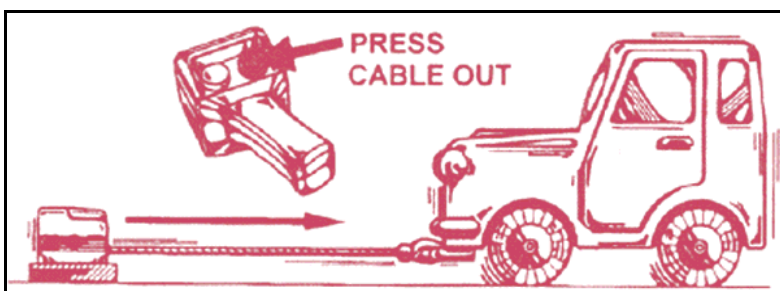

Figure 16.2



*When using the Winch to pull or position a load, always use straps or chains rated at a greater capacity than the winch.*



*When spooling the cable, the acute angle formed by the cable and the horizontal line shall never exceed 15 degrees (see Figure 17).*

Figure 17

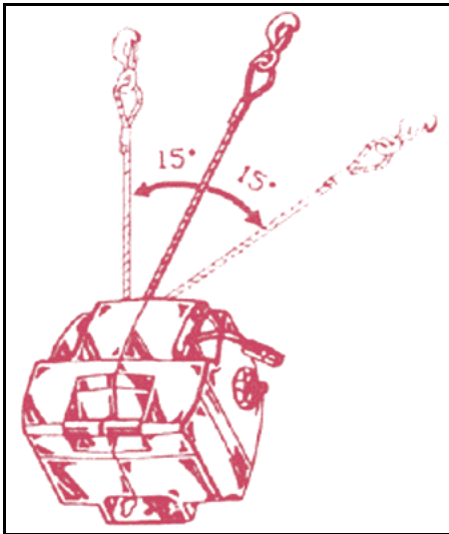

*Never extend the cable by adding the extra cable to the winch spool. Each spool is designed to safely accommodate a specific length of the cable. To do so would result in spool axle failure, possible immediate loss of load, and damage to property and personal injury.*

### **Free Wheel Function**

To use the free wheel function, turn the clutch knob counterclockwise (no more than 2 full turns). Wear leather gloves, and pull the cable from the winch spool until desired length is reached.

### **Use of Emergency Hand Crank**

1. Turn the clutch knob clockwise until tight. Do not over tighten or the clutch will be damaged.
2. Remove the plastic cap on the other side of the clutch knob.
3. Place the emergency hand crank on the shaft (see Figure 18).

Figure 18

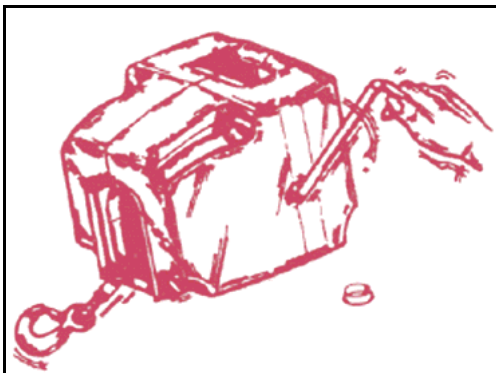

4. Swing the emergency hand crank counter clockwise to pull the load.

*DO NOT use the emergency hand crank to help assist an operating winch motor. This will damage the winch and result in personal injury. It can only be used when power supply is set off.*

5. After use remove the emergency hand crank, and replace the plastic Cap back in place.

## Use Of Pulley Block Assembly

### Introduction

The winch is equipped with pulley block assembly and a hook. Proper use of pulley block assembly will nearly double the capacity of the winch. Care shall be taken to secure pulley block assembly. It is recommended to use pulley block assembly for recovery in gumbo mud or deep snow. The recovery time will become slower when pulley block assembly is used.

When pulley block assembly is applied, be sure that the anchor point of the hook shall be secured to withstand the double line rated capacity of the winch.

### Remove Pulley Block Assembly

Remove the wing nut, the lock washer and the pull bolt, and guide the cable from pulley block assembly. When reinstalling pulley block assembly be sure that the wing nut, the lock washer and the pull bolt are screwed tightly.

## Maintenance

The owner and/or the operator shall be aware that repair of the winch requires specialized knowledge and facilities. It is recommended to have an annual inspection of the winch done by a local service center and that any defect parts be replaced with genuine MVP parts.

1. Lubricate the cable occasionally, or more often when used frequently.
2. Grease gears every six months. To do this, remove the clutch knob and separate the left and right housing. Use any marine type grease.
3. When the cable becomes fraying, be sure to follow the procedure below to replace with a new one.
  - Unspool the entire cable, then cut and take it out from the winch spool (it is not necessary to separate the winch spool from the winch unit during the procedure).
  - Insert the replacement cable into the winch spool (see Figure 19), and attach the cable to the hook with 2 cable clamps (enclosed). Then screw cable clamps on tightly.

Figure 19

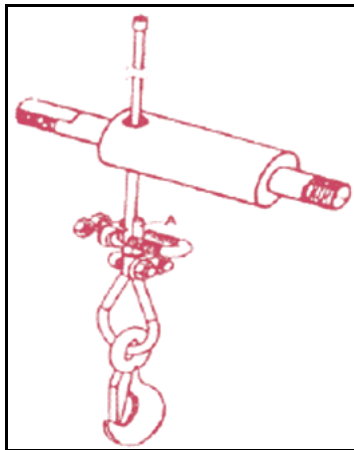

## Operation Tips

### Tip 1

When using of the free wheel function, the cable can not be easily pulled out of the winch spool though the clutch knob has been released counterclockwise.

Completely release the clutch knob by turning counterclockwise. Place the emergency hand crank on the shaft (see Figure 18), and swing it clockwise This may help to release the cable manually.

*When spooling the cable, it is recommended to winch a load.*

### Tip 2

When winching a load, the clutch is slipping, and producing noises though the winch motor is running.

Examine the clutch knob to make sure that it is properly tightened clockwise. If the clutch knob is tightened and the clutch remains slipping, it indicates that the force needed to winch the load exceeds the line pull capacity. It is suggested to either stop operating the winch, or use pulley block assembly to winch the load instead.

### Tip 3

When winching a load, the circuit breaker disconnects the power supply due to overheating. It may show the following two possibilities:

- a) The force needed to winch the load is closer/ higher than the line pull capacity.
- b) The functioning time of the winch has been too long.

The user shall then stop operating the winch for 30 seconds. If the circuit breaker still periodically disconnects the power supply after each recovery, it indicates that the force needed to winch the load exceeds the line pull capacity. It is suggested to either stop operating the winch, or use pulley block assembly to winch the load instead.

Stop pressing the buttons of the remote control when the circuit breaker disconnects the power supply due to overheating. An accidental start of the winch may occur if the user continues pressing the button. This may result in personal injury and/or property damage.

### Tip 4

Shortage of power supply.

When there is shortage of power supply, the emergency hand crank may be employed. However, the user has to be sure that he/she is able to manually handle the winching process. **Please note that if there is no load applied, the clutch knob shall be loosened counterclockwise. If there is a load applied, the clutch knob shall be tightened clockwise.**

## Specifications

Model	Rolling Load Capacity		Marine Capacity		Power Draw		Cable Specs		Noise Level	Net Weight
	Single Line	Double Line	Max Boat Weight	Max Boat Length	Power Supply	Circuit Breaker	Cable Length	Cable Diameter		
	Kg	Kg	Kg	M	Volt DC	Amp	M	Mm	Db	Kg
U0701	9000	15000	5000	5.5	12	20	13	6	84	20
U0701	9000	15000	5000	5.5	24	15	13	6	84	20

## Spare Part List

Part #	Description
1	Motor (for U0701)
1.1	Motor (for U0702)
2	Spring Brake Assembly
3	Circuit Braker (for U0701)
3.1	Circuit Braker (for U0702)
4	Electrical Cord
5	Remote Control
6	Housing Assembly
7	Clutch Knob
8	Hand Crank
9	Adapter Plate
10	Cable Assembly
11	Pulley Block

Spare Part Drawing

