

Contents

Before driving

Introduction	2
Instrumentation	4
Controls and features	21
Seating and safety restraints	72

Starting and driving

Starting	99
Driving	104
Roadside emergencies	135

Servicing

Maintenance and care	156
Capacities and specifications	197
Reporting safety defects	205
Index	206

All rights reserved. Reproduction by any means, electronic or mechanical including photocopying, recording or by any information storage and retrieval system or translation in whole or part is not permitted without written authorization from Ford Motor Company.

Introduction

ICONS

Indicates a warning. Read the following section on *Warnings* for a full explanation.



Indicates vehicle information related to recycling and other environmental concerns will follow.



Correct vehicle usage and the authorized disposal of waste cleaning and lubrication materials are significant steps towards protecting the environment.

WARNINGS

Warnings provide information which may reduce the risk of personal injury and prevent possible damage to others, your vehicle and its equipment.

BREAKING-IN YOUR VEHICLE

There are no particular breaking-in rules for your vehicle. During the first 1 600 km (1 000 miles) of driving, vary speeds frequently. This is necessary to give the moving parts a chance to break in.

If possible, you should avoid full use of the brakes for the first 1 600 km (1 000 miles).

INFORMATION ABOUT THIS GUIDE

The information found in this guide was in effect at the time of printing. Ford may change the contents without notice and without incurring obligation.

SPECIAL NOTICES

Notice to owners of utility type vehicles

Before you drive your vehicle, please read this Owner's Guide carefully. Your vehicle is not a passenger car. As with other vehicles of this type, failure to operate this vehicle correctly may result in loss of control or an accident.

Be sure to read *Driving off road* in the *Driving* chapter as well as the "Four Wheeling" supplement included with 4WD and utility type vehicles.

Using your vehicle as a snowplow



Do not use this vehicle for snowplowing.

Using your vehicle as an ambulance



Do not use this vehicle as an ambulance.

Your vehicle is not equipped with the Ford Ambulance Preparation package.

Instrumentation

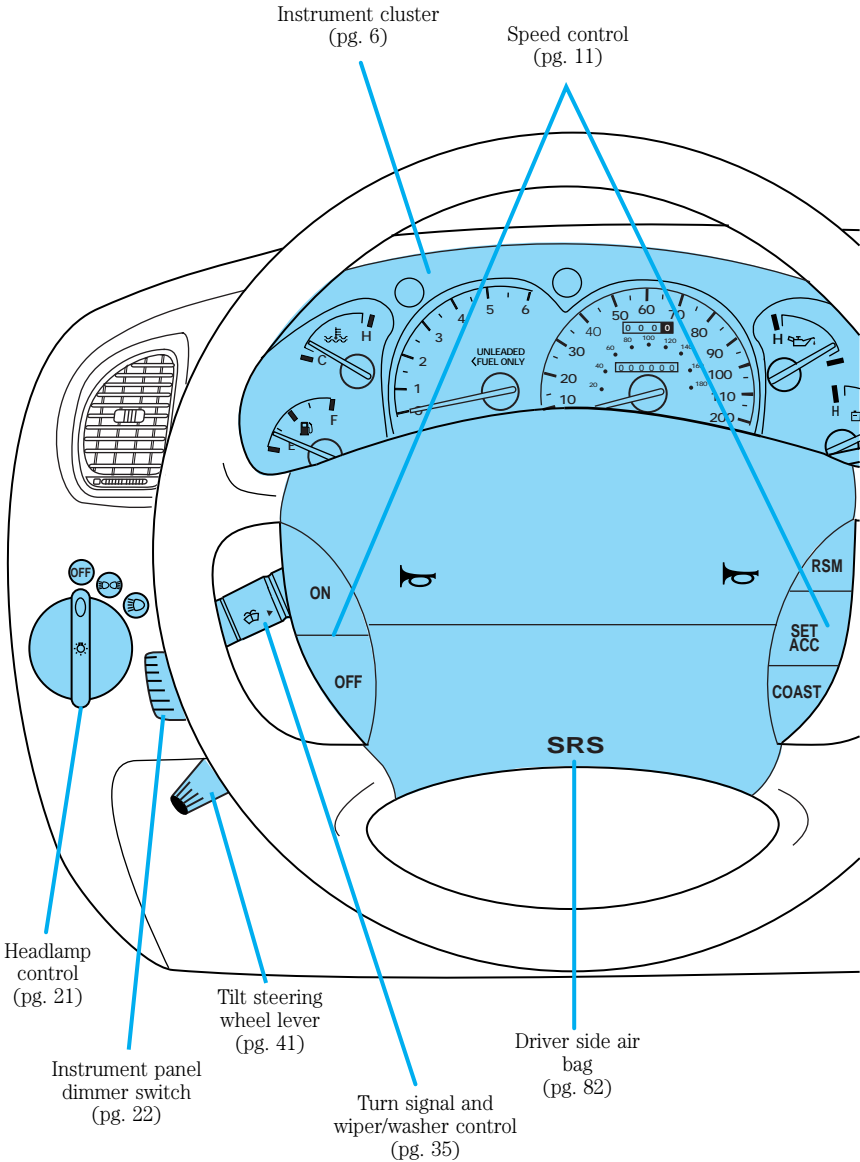

Instrumentation

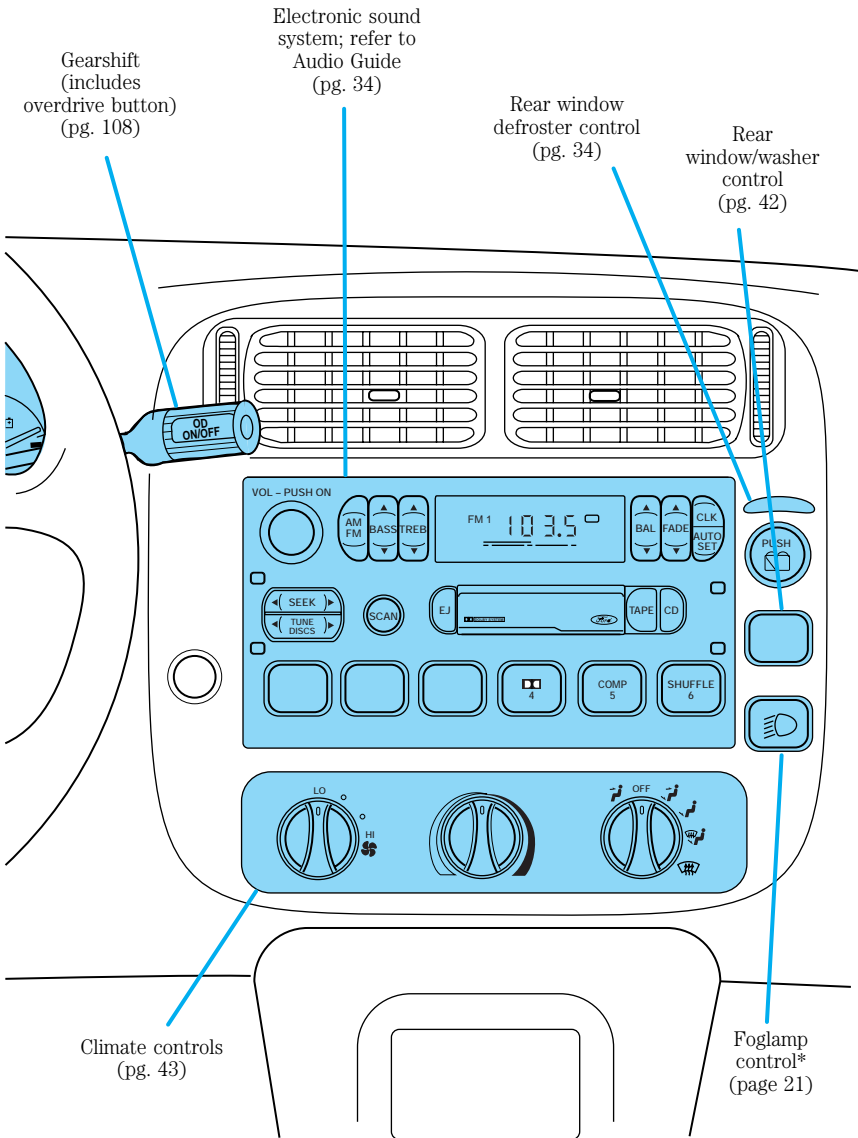

Instrumentation

WARNING LIGHTS AND CHIMES

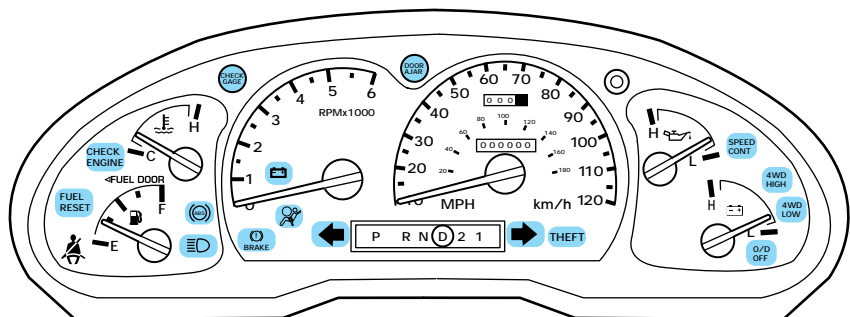

Check engine

Your vehicle is equipped with a computer that monitors the engine's emission control system. This system is commonly known as the On Board Diagnostics System (OBD II). This OBD II system protects the environment by ensuring that your vehicle continues to meet government emission standards. The OBD II system also assists the service technician in properly servicing your vehicle.

The *Check Engine* indicator light illuminates when the ignition is first turned to the ON position to check the bulb. If it comes on after the engine is started, one of the engine's emission control systems may be malfunctioning. The light may illuminate without a drivability concern being noted. The vehicle will usually be drivable and will not require towing.

CHECK ENGINE

What you should do if the check engine light illuminates

Light turns on solid:

This means that the OBD II system has detected a malfunction.

Temporary malfunctions may cause your *Check Engine* light to illuminate. Examples are:

1. The vehicle has run out of fuel. (The engine may misfire or run poorly.)
2. Poor fuel quality or water in the fuel.
3. The fuel cap may not have been properly installed and securely tightened.

These temporary malfunctions can be corrected by filling the fuel tank with good quality fuel and/or properly installing and securely tightening the gas cap. After three driving cycles without these or any other temporary malfunctions present, the *Check Engine* light should turn off. (A driving cycle consists of a cold engine startup followed by mixed city/highway driving.) No additional vehicle service is required.

If the *Check Engine* light remains on, have your vehicle serviced at the first available opportunity.

Light is blinking:

Engine misfire is occurring which could damage your catalytic converter. You should drive in a moderate fashion (avoid heavy acceleration and deceleration) and have your vehicle serviced at the first available opportunity.



Under engine misfire conditions, excessive exhaust temperatures could damage the catalytic converter, the fuel system, interior floor coverings or other vehicle components, possibly causing a fire.

Fuel reset

Illuminates when the ignition key is turned to the ON position and the fuel pump shut-off switch has been triggered. For more information, refer to *Fuel pump shut-off switch* in the *Roadside emergencies* chapter.

FUEL RESET

Instrumentation

Air bag readiness

Momentarily illuminates when the ignition is turned ON. If the light fails to illuminate, continues to flash or remains on, have the system serviced immediately.



Safety belt

Momentarily illuminates when the ignition is turned ON to remind you to fasten your safety belts. For more information, refer to the *Seating and safety restraints* chapter.



Brake system warning

Momentarily illuminates when the ignition is turned ON and the engine is off. Also illuminates when the parking brake is engaged.

Illumination after releasing the parking brake indicates low brake fluid level.



Anti-lock brake system (ABS)

Momentarily illuminates when the ignition is turned on and the engine is off. If the light remains on, continues to flash or fails to illuminate, have the system serviced immediately.



Turn signal

Illuminates when the left or right turn signal or the hazard lights are turned on. If one or both of the indicators stay on continuously, check for a burned-out turn signal bulb. Refer to *Exterior bulbs* in the *Maintenance and care* chapter.

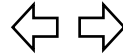

High beams

Illuminates when the high beam headlamps are turned on.



Anti-theft system (if equipped)

Refer to *Anti-theft system* in the *Controls and features* chapter.



Charging system

Momentarily illuminates when the ignition is turned ON and the engine is off. The light also illuminates when the battery is not charging properly, requiring electrical system service.

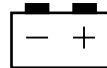

Instrumentation

Check gage

Illuminates when the key is in the ON position and the engine coolant temperature is high, the engine oil pressure is low or the fuel level is near empty. Refer to *Engine coolant temperature gauge*, *Engine oil pressure gauge* or *Fuel gauge* in this chapter for more information.

**CHECK
GAGE**

Four wheel drive low (if equipped)

Illuminates when four-wheel drive low is engaged.

**4WD
LOW**

Four wheel drive high (if equipped)

Illuminates when four-wheel drive high is engaged.

**4WD
HIGH**

Door ajar

Illuminates when the ignition switch is in the ON or START position and any door is open.

**DOOR
AJAR**

O/D off (if equipped)

Illuminates when the transmission control switch has been pushed. When the light is on, the transmission does not shift into overdrive. If the light does not come on when the transmission control switch is depressed or if the light flashes when you are driving, have your vehicle serviced.

**O/D
OFF**

Speed control (if equipped)

This light comes on when either the SET/ACCEL or RESUME controls are pressed. It turns off when the speed control OFF control is pressed, the brake is applied or the ignition is turned to the OFF position.

**SPEED
CONT**

Safety belt warning chime

Chimes to remind you to fasten your safety belts.

For information on the safety belt warning chime, refer to the *Seating and safety restraints* chapter.

Supplemental restraint system (SRS) warning chime

For information on the SRS warning chime, refer to the *Seating and safety restraints* chapter.

Key-in-ignition warning chime

Sounds when the key is left in the ignition in the OFF/LOCK or ACC position and the driver's door is opened.

Headlamps on warning chime

Sounds when the headlamps or parking lamps are on, the ignition is off (and the key is not in the ignition) and the driver's door is opened.

Instrumentation

GAUGES

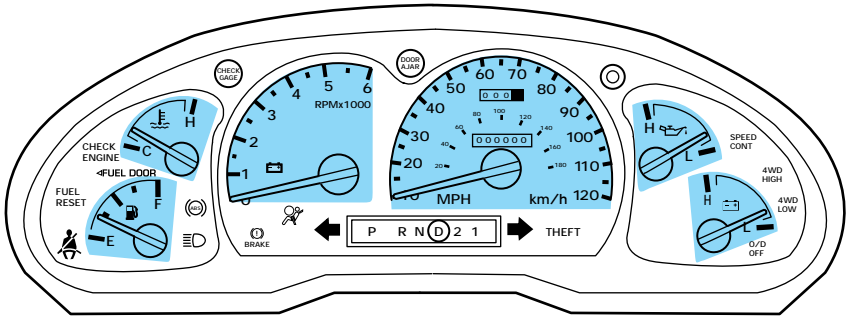

Speedometer

Indicates the current vehicle speed.

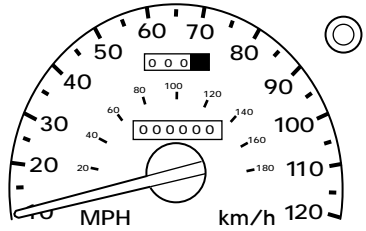

Engine coolant temperature gauge

Indicates the temperature of the engine coolant. At normal operating temperature, the needle remains within the normal area (the area between the “H” and “C”). If it enters the red section, the engine is overheating. Stop the vehicle as soon as safely possible, switch off the ignition and let the engine cool. Refer to *Engine coolant* in the *Maintenance and care* chapter.

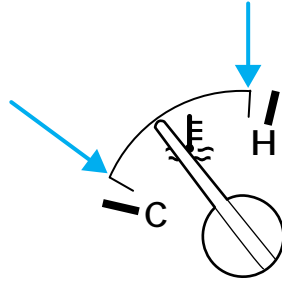

Never remove the coolant recovery cap while the engine is running or hot.

This gauge indicates the temperature of the engine coolant, not the coolant level. If the coolant is not at its proper level or mixture, the gauge indication will not be accurate.

Odometer

Registers the total kilometers (miles) of the vehicle.

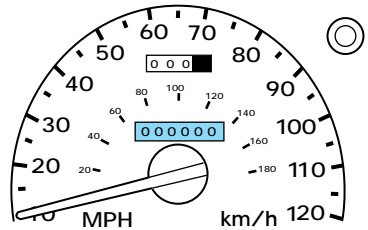

Instrumentation

Trip odometer

Registers the kilometers (miles) of individual journeys. To reset, depress the control.

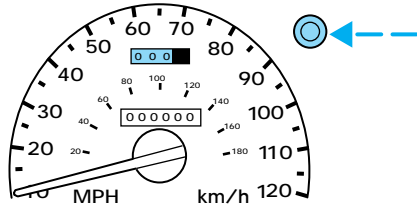

Tachometer

Indicates the engine speed in revolutions per minute.

Driving with your tachometer pointer in the red zone may damage the engine.

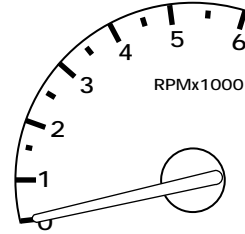

Battery voltage gauge

This gauge shows the battery voltage when the ignition is in the ON position. If the pointer moves and stays outside the normal operating range (as indicated), have the vehicle's electrical system checked as soon as possible.

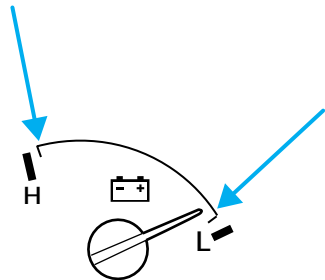

Engine oil pressure gauge

This shows the engine oil pressure in the system. Sufficient pressure exists as long as the needle remains in the normal range (the area between the “H” and “L”).

If the gauge indicates low pressure, stop the vehicle as soon as safely possible and switch off the engine immediately. Check the oil level.

Add oil if needed (refer to *Checking and adding engine oil* in the *Maintenance and care* chapter). If the oil level is correct, have your vehicle checked at your dealership or by a qualified technician.

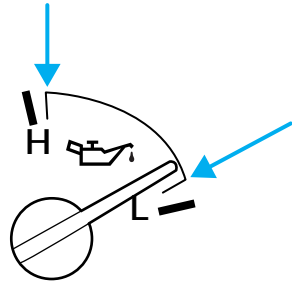

Fuel gauge

Displays approximately how much fuel is in the fuel tank (when the key is in the ON position). The fuel gauge may vary slightly when the vehicle is in motion. The ignition should be in the OFF position while the vehicle is being refueled. When the gauge first indicates empty, there is a small amount of reserve fuel in the tank. When refueling the vehicle from empty indication, the amount of fuel that can be added will be less than the advertised capacity due to the reserve fuel.

The FUEL DOOR icon and arrow indicates which side of the vehicle the fuel filler door is located.



Instrumentation

MESSAGE CENTER (IF EQUIPPED)

With the ignition in the ON position, the message center displays important vehicle information through a constant monitor of vehicle systems. You may select display features on the message center for a display of status preceded by a brief indicator chime. The system will also notify you of potential vehicle problems with a display of system warnings.

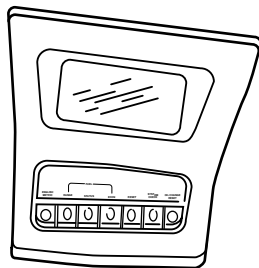

Selectable features

English/metric display

Press to toggle the message center display between metric or English units.

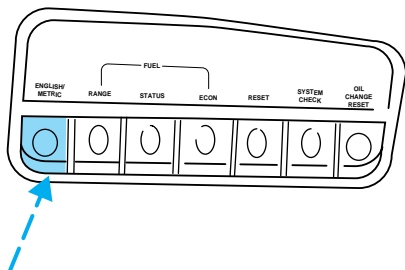

Fuel range

Press once to display the approximate kilometers (miles) left to drive before the fuel tank is empty.

Press again to display the distance driven since this function was last manually reset.

For maximum accuracy of this display feature, the ignition should be in the Off position during fueling. The display FUEL LEVEL ERROR indicates a problem with the fuel indication system. See your dealer or qualified service technician for system maintenance.

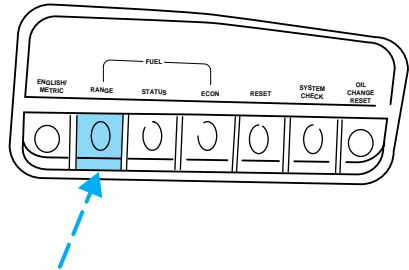

Fuel status

Press once to display the approximate amount of fuel remaining in the fuel tank.

Press again to display the approximate amount of fuel used since the system was last reset.

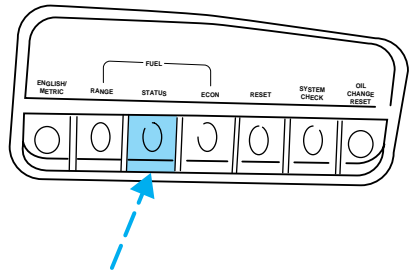

Instrumentation

Fuel economy

Press once to display your vehicle's average fuel economy in kilometers/liters (miles/gallons).

Press again to display the fuel economy that your vehicle is getting at that particular time. Your vehicle must be moving in order for this display to function properly.

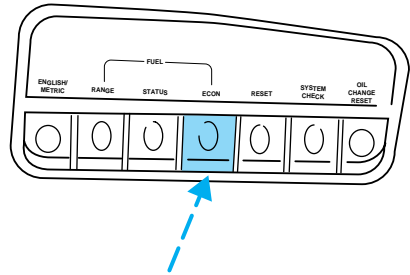

Reset

Press the reset control to reset the current feature being displayed. Warnings, distance driven, average fuel economy, fuel used and personalized oil reset percentage are the only features that respond to reset.

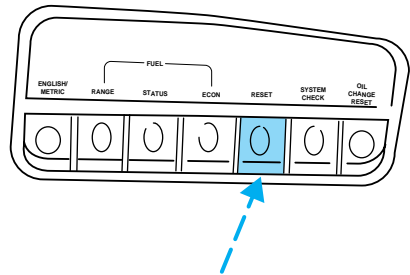

System check

Press the system check control to display the status of the following systems:

- engine oil life left
- engine oil level
- voltage level
- engine coolant temperature
- washer fluid level
- automatic ride control (if equipped)
- fuel level

The engine oil life left has two phases. The first display will indicate the oil change status (OK, SOON, REQUIRED). The second display will indicate the percentage of oil life remaining. The display OIL TEMP SIGNAL ERROR indicates a problem with the system. Following this display, contact your dealer or qualified service technician for system maintenance.

Operating the message center during system check

The message center controls can be operated as follows during the system check sequence:

1. Press the system check controls to advance to the next display.
2. Press the reset control to immediately conclude the system check.
3. Press the range, fuel status or fuel economy control to conclude the system check and display the requested feature.
4. Press the metric/English control to conclude the system check and change the previous display to the new mode.
5. Press the oil change reset control to conclude the system check and begin the oil change reset procedure.

An oil change is recommended whenever indicated by the message center. Use only recommended engine oils.

The message center will tell you the percent of oil life left during system check. This percentage is based on your driving history and the time since your last oil change. In order to ensure accurate oil life left

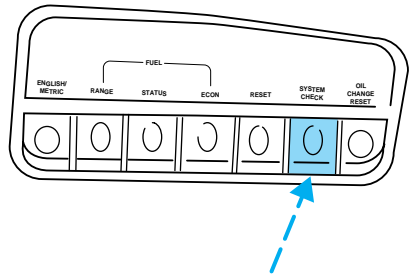

Instrumentation

indications, you should only perform the following procedure after you have the oil changed.

Oil change reset

Press the OIL CHANGE RESET control to reset the oil life feature to 100% (or your personalized oil reset percentage). After you have the oil changed, you must press and hold the OIL CHANGE RESET control for five seconds. The message center will count down for five seconds. After a successful reset, the message center will display OIL LIFE RESET TO 100%. (If you have established a personalized oil reset percentage, the display will show that percentage instead of 100%.) This reset procedure should be performed only after an oil change to ensure accurate oil life indications.

Your personalized oil reset percentage allows you to establish a smaller oil change interval than the manufacturer's recommended interval. To establish your personalized oil reset percentage:

1. Press and hold the OIL CHANGE RESET control and press the RESET control while the display is still counting down the 5 seconds to reset. The display will change to START OIL LIFE AT XXX%.
2. Press the OIL CHANGE RESET control until the displayed percentage is the personalized oil reset percentage you desire. Your choices are 100%, 90%, 80%, 70%, 60%, 50%, 40% and 30%.

1. Press the RESET control to complete the procedure. Pressing any control other than RESET or OIL CHANGE RESET will abort this procedure and will not establish your new personalized oil reset percentage.

When your personalized oil reset percentage has been established, it will be used beginning with the completion of your next OIL CHANGE RESET procedure.

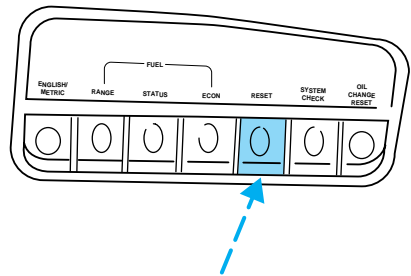
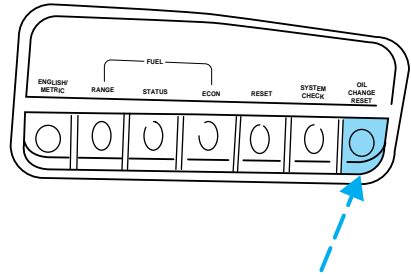

HEADLAMP CONTROL

Rotate the headlamp control clockwise to the first position to turn on the parking lamps only. Rotate to the second position to also turn on the headlamps.

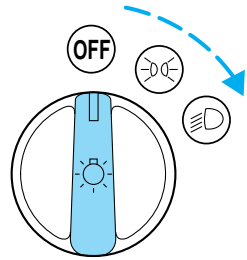

Foglamp control (if equipped)

Turn on the low-beam headlamps and press the foglamp control to activate the foglamps. The foglamp control button will illuminate when the foglamps are on.

Press the foglamp control a second time to deactivate the foglamps.

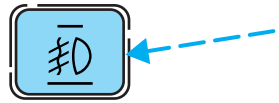

Daytime running lamps (DRL) (if equipped)

Turns the highbeam headlamps on with a reduced output. To activate:

- the engine must be running
- the headlamp control is in the OFF or Parking lamps position.



The Daytime Running Light (DRL) system will not illuminate the tail lamps and parking lamps. Turn on your headlamps at dusk. Failure to do so may result in a collision.

Controls and features

High beams

Push forward to activate.

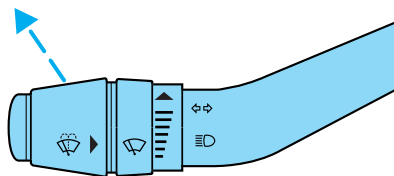

Flash to pass

Pull toward you to activate and release to deactivate.

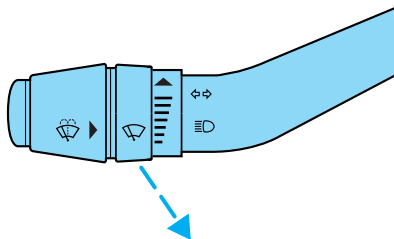

PANEL DIMMER CONTROL

Use to adjust the brightness of the instrument panel during headlight and parklamp operation.

- Rotate up to brighten.
- Rotate down to dim.

Use to control the dome lamps.

- Rotate all the way up to turn on.
- Rotate all the way down to override.

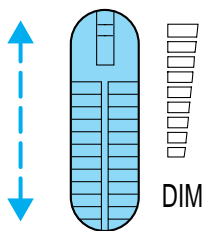

Controls and features

CLIMATE CONTROL SYSTEM

Manual heating and air conditioning system (if equipped)

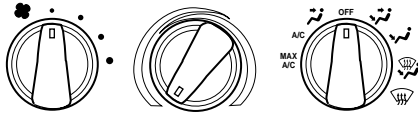

Fan speed control

Controls the volume of air circulated in the vehicle.



Temperature control knob

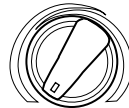

Controls the temperature of the airflow inside the vehicle.

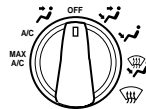

Mode selector control

Controls the direction of the airflow to the inside of the vehicle.







The air conditioning compressor will operate in all modes except  and . However, the air conditioning will only function if the outside temperature is about 10°C (50°F) or above.

Controls and features

Since the air conditioner removes considerable moisture from the air during operation, it is normal if clear water drips on the ground under the air conditioner drain while the system is working and even after you have stopped the vehicle.

Under normal conditions, your vehicle's climate control system should be left in any position other than MAX A/C or OFF when the vehicle is parked. This allows the vehicle to "breathe" through the outside air inlet duct.

- **MAX A/C**-Uses recirculated air to cool the vehicle. MAX A/C is noisier than A/C but more economical and will cool the inside of the vehicle faster. Airflow will be from the instrument panel registers. This mode can also be used to prevent undesirable odors from entering the vehicle.
- **A/C**-Uses outside air to cool the vehicle. It is quieter than MAX A/C but not as economical. Airflow will be from the instrument panel registers.
-  (Vent)-Distributes outside air through the instrument panel registers. However, the air will not be cooled below the outside temperature because the air conditioning does not operate in this mode.
- **OFF**-Outside air is shut out and the fan will not operate. For short periods of time only, use this mode to prevent undesirable odors from entering the vehicle.
-  (Panel and floor)-Distributes outside air through the instrument panel registers and the floor ducts. Heating and air conditioning capabilities are provided in this mode. For added customer comfort, when the temperature control knob is anywhere in between the full hot and full cold positions, the air distributed through the floor ducts will be slightly warmer than the air sent to the instrument panel registers.
-  (Floor)-Allows for maximum heating by distributing outside air through the floor ducts. However, the air will not be cooled below the outside temperature because the air conditioning does not operate in this mode.
-  (Floor and defrost)-Distributes outside air through the windshield defroster ducts and the floor ducts. Heating and air conditioning capabilities are provided in this mode. For added customer comfort, when the temperature control knob is anywhere in between the full hot and full cold positions, the air distributed through

Controls and features

the floor ducts will be slightly warmer than the air sent to the instrument panel registers. If the temperature is about 10°C (50°F) or higher, the air conditioner will automatically dehumidify the air to prevent fogging.

-  -Distributes outside air through the windshield defroster ducts. It can be used to clear ice or fog from the windshield. If the temperature is about 10°C (50°F) or higher, the air conditioner will automatically dehumidify the air to prevent fogging.

Operating tips

- In humid weather, select  before driving. This will prevent your windshield from fogging. After a few minutes, select any desired position.
- To prevent humidity buildup inside the vehicle, don't drive with the climate control system in the OFF position.
- Don't put objects under the front seat that will interfere with the airflow to the back seats.
- Remove any snow, ice or leaves from the air intake area (at the bottom of the windshield under the hood).

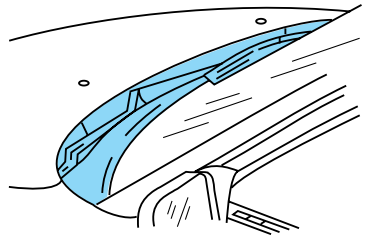

- If your vehicle has been parked with the windows closed during hot weather, the air conditioner will do a much faster job of cooling if you drive for two or three minutes with the windows open. This will force most of the hot, stale air out of the vehicle. Then operate your air conditioner as you would normally.
- When placing objects on top of your instrument panel, be careful to not place them over the defroster outlets. These objects can block airflow and reduce your ability to see through your windshield. Also, avoid placing small objects on top of your instrument panel. These objects can fall down into the defroster outlets and block airflow and possibly damage your climate control system.

Controls and features

Electronic Automatic Temperature Control (EATC) system (if equipped)

The EATC system will maintain a selected temperature and automatically control airflow. You can override automatic operation with any of the override controls, the fan speed control or the steering wheel controls.

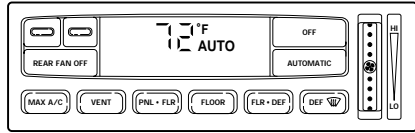

Turning the EATC on

Press AUTOMATIC, any of the override controls or the fan speed control. The EATC will only operate when the ignition is in the ON position.

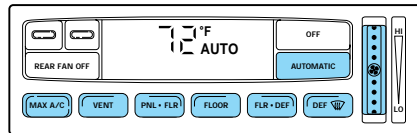

Turning the EATC off

Press OFF.

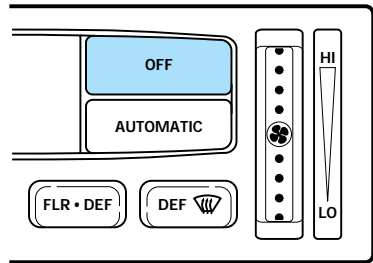

Automatic operation

Press AUTOMATIC and select the desired temperature. The selected temperature and the word AUTO will appear in the display window. The EATC system will either heat or cool to achieve the selected temperature. The system will automatically determine fan speed, airflow location and if fresh outside air or recirculated air is required. Fan speed

Controls and features

remains automatic unless the fan speed thumbwheel is turned or the steering wheel fan speed control is pressed.

When in AUTOMATIC and weather conditions require heat, air will be sent to the floor. However, if the engine is not warm enough to provide heat, the fan will be at a low speed and the air will be directed to the windshield. In 3½ minutes or less, the fan speed will start to increase and the airflow location will change to the floor area.

If unusual conditions exist (i.e.-window fogging, etc.), the manual override controls allow you to select airflow locations and the fan control allows you to adjust fan speed as necessary.

Temperature selection

The display window indicates the selected temperature, function (AUTO or one of the override controls) and manual control of fan speed (☼) if automatic fan speed is not desired.



To control the temperature, select any temperature between 18°C (65°F) and 29°C (85°F) by pressing the blue (cooler) or red (warmer) buttons.

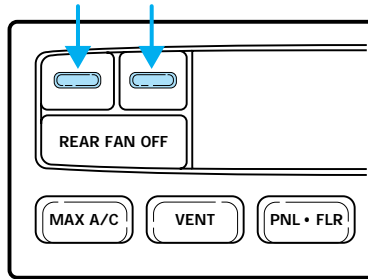

For continuous maximum cooling, push the blue button until 16°C (60°F) is shown in the display window. The EATC will continue maximum cooling (disregarding the displayed temperature) until a warmer temperature is selected by pressing the red button.

For continuous maximum heating, push the red button until 32°C (90°F) is shown in the display window. The EATC will continue maximum heating (disregarding the displayed temperature) until a cooler temperature is selected by pressing the blue button.

Controls and features

Temperature conversion

Press MAX A/C and DEF  at the same time (for one second) to switch between Fahrenheit and Celsius.

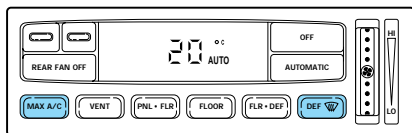

If your vehicle has an English/Metric (E/M) control, this control will also change the temperature display

Fan speed

When AUTOMATIC is pressed, fan speed is adjusted automatically for existing conditions. You can override fan speed at any time. To control fan speed manually, use the thumbwheel or steering wheel control to cancel automatic fan speed operation. Rotate the thumbwheel up for higher fan speed or down for lower fan speed. Press the steering wheel fan speed control up for higher fan speed or down for lower fan speed.

The display will show  to indicate manual fan operation.

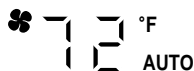
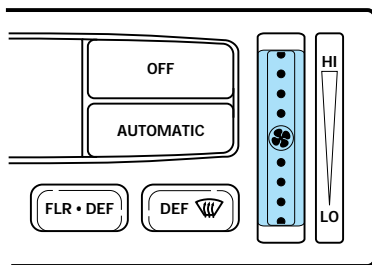

To return to automatic fan operation, press AUTOMATIC.

Controls and features

Manual override controls

The override controls are located at the bottom of the EATC and allow you to determine where airflow is directed. To return to full automatic control, press AUTOMATIC.

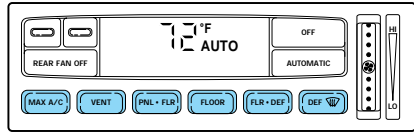

The air conditioning compressor will operate in all modes except FLOOR and VENT. It will also operate only when required when AUTOMATIC has been selected. However, the air conditioning will only function if the outside temperature is about 10°C (50°F) or above.

Since the air conditioner removes considerable moisture from the air during operation, it is normal if clear water drips on the ground under the air conditioner drain while the system is working and even after you have stopped the vehicle.

Under normal conditions, your vehicle's climate control system should be left in any position other than MAX A/C or OFF when the vehicle is parked. This allows the vehicle to "breathe" through the outside air inlet duct.

- **MAX A/C**-Uses recirculated air to cool the vehicle. The temperature will display 16°C (60°F). To exit, press AUTOMATIC or any other override controls. MAX A/C is noisier than normal A/C but more economical and will cool the inside of the vehicle faster. Airflow is from the instrument panel registers. This mode can also be used to prevent undesirable odors from entering the vehicle.
- **VENT**-Distributes outside air through the instrument panel registers. However, the air cannot be cooled below the outside temperature because the air conditioning does not operate in this mode.
- **PNL • FLR** -Distributes outside air through the instrument panel registers and the floor ducts. Heating and air conditioning capabilities are provided in this mode. The air will be heated or cooled based on the temperature selection. For added customer comfort, the air distributed through the floor ducts will be slightly warmer than the air sent to the instrument panel registers.

Controls and features

- **FLOOR**-Allows for maximum heating by distributing outside air through the floor ducts. However, the air cannot be cooled below the outside temperature because the air conditioning does not operate in this mode.
- **FLR • DEF**-Distributes outside air through the windshield defroster ducts and the floor ducts. Heating and air conditioning capabilities are provided in this mode. The air will be heated or cooled based on the temperature selection. For added customer comfort, the air distributed through the floor ducts will be slightly warmer than the air sent to the windshield defroster ducts. If the temperature is about 10°C (50°F) or higher, the air conditioner will automatically dehumidify the air to prevent fogging.
- **DEF**  -Distributes outside air through the windshield defroster ducts. It can be used to clear ice or fog from the windshield. If the outside air temperature is about 10°C (50°F) or higher, the air conditioner will automatically dehumidify the air to prevent fogging.
- **OFF**-Outside air is shut out and the fan will not operate. For short periods of time only, use this mode to prevent undesirable odors from entering the vehicle.

Rear fan off

Press **REAR FAN OFF** to turn off the rear console fan. This overrides the rear console fan speed control.

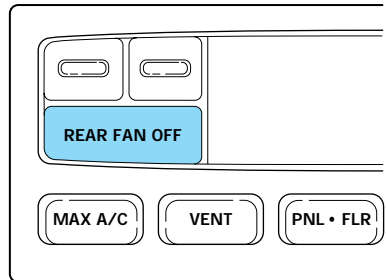

The EATC display window will indicate **REAR FAN OFF**.

The rear console fan will remain off until **REAR FAN OFF** is pressed again.

Controls and features

Operating tips

- In humid weather, select DEF  before driving. This will prevent your windshield from fogging. After a few minutes, select any desired position.
- To prevent humidity buildup inside the vehicle, don't drive with the climate control system in the OFF position.
- Don't put objects under the front seat that will interfere with the airflow to the back seats.
- Remove any snow, ice or leaves from the air intake area (at the bottom of the windshield).

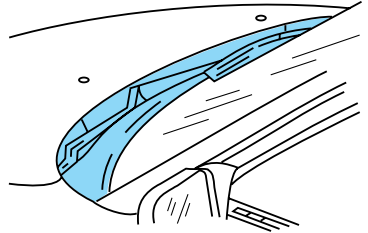

- If your vehicle has been parked with the windows closed during hot weather, the air conditioner will do a much faster job of cooling if you drive for two or three minutes with the windows open. This will force most of the hot, stale air out of the vehicle. Then operate the air conditioner as you would normally.
- When placing objects on top of your instrument panel, be careful to not place them over the defroster outlets. These objects can block airflow and reduce your ability to see through your windshield. Also, avoid placing small objects on top of your instrument panel. These objects can fall down into the defroster outlets and block airflow and possibly damage your climate control system.

Controls and features

Rear console climate controls (if equipped)

Depending on the equipment package of your vehicle, the rear console may not be equipped with rear console audio/climate controls. Turn the air distribution control to the desired airflow position.

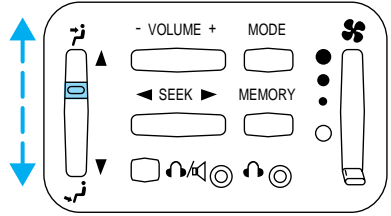

The instrument panel climate controls must be on in order for the rear climate control console controls to work.

Turn the fan speed control to the desired position.

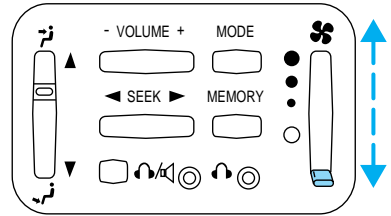

Controls and features

Select  for air to flow through these vents:

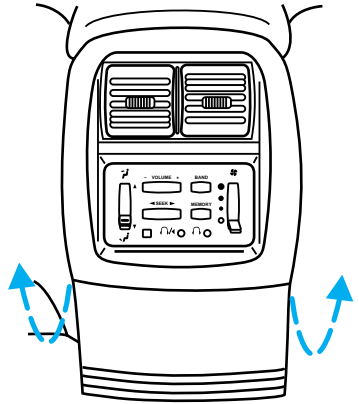

Select  for air to flow through these vents:

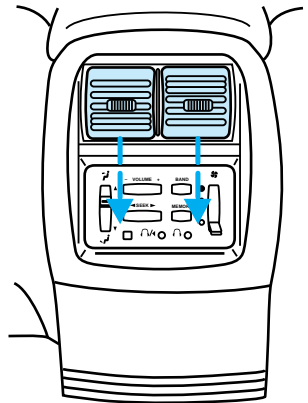

Controls and features

REAR WINDOW DEFROSTER

The rear defroster control is located on the instrument panel.

Press the defroster control to clear the rear window of thin ice and fog.

- The small LED will illuminate when the defroster is activated.

The ignition must be in the ON position to operate the rear window defroster.

The defroster turns off automatically after 10 minutes or when the ignition is turned to the OFF position. To manually turn off the defroster before ten minutes have passed, push the control again.

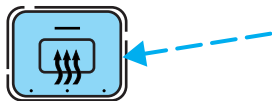

4WD CONTROL (IF EQUIPPED)

This control operates the 4WD.

Refer to *Four-wheel drive (4WD) operation* in the *Driving* chapter for more information.

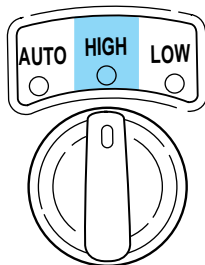

AUDIO SYSTEM

Refer to the “Audio Guide” in your owner portfolio.

Controls and features

TURN SIGNAL CONTROL

- Push down to activate the left turn signal.
- Push up to activate the right turn signal.

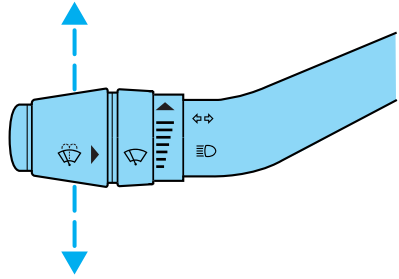

POSITIONS OF THE IGNITION

1. **ACCESSORY**, allows the electrical accessories such as the radio to operate while the engine is not running.
2. **LOCK**, locks the steering wheel, automatic transmission gearshift lever and allows key removal.
3. **OFF**, shuts off the engine and all accessories without locking the steering wheel.
4. **ON**, all electrical circuits operational. Warning lights illuminated. Key position when driving.
5. **START**, cranks the engine. Release the key as soon as the engine starts.

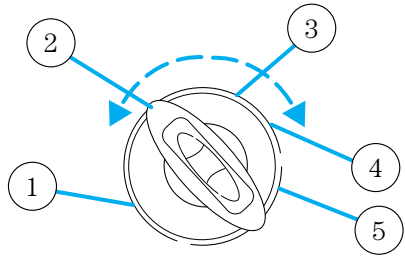

Controls and features

SPEED CONTROL (IF EQUIPPED)

To turn speed control on

- Press ON.

Vehicle speed cannot be controlled until the vehicle is traveling at or above 48 km/h (30 mph).

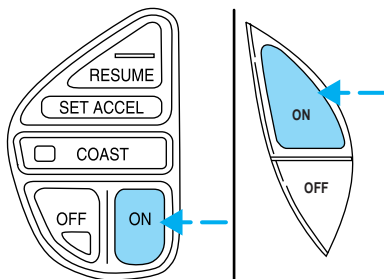

Do not use the speed control in heavy traffic or on roads that are winding, slippery, or unpaved.



Do not shift the gearshift lever into N (Neutral) with the speed control on.

To turn speed control off

- Press OFF or
- Turn off the vehicle ignition.

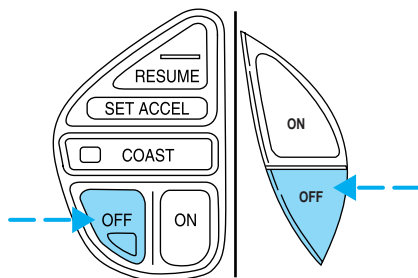

Once speed control is switched off, the previously programmed set speed will be erased.

To set a speed

- Press SET ACC/SET ACCEL. For speed control to operate, the speed control must be ON and the vehicle speed must be greater than 48 km/h (30 mph).

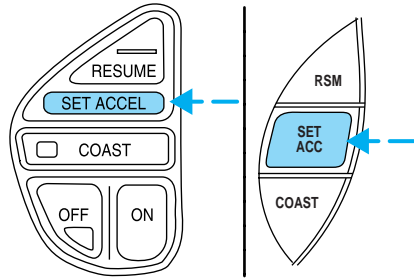

If you drive up or down a steep hill, your vehicle speed may vary momentarily slower or faster than the set speed. This is normal.

Speed control cannot reduce the vehicle speed if it increases above the set speed on a downhill. If your vehicle speed is faster than the set speed while driving on a downhill, you may want to shift to the next lower gear or apply the brakes to reduce your vehicle speed.

If your vehicle slows down more than 16 km/h (10 mph) below your set speed on an uphill, your speed control will disengage. This is normal. Pressing RES/RSM/RESUME will re-engage it.



Do not use the speed control in heavy traffic or on roads that are winding, slippery, or unpaved.

Controls and features

To set a higher set speed

- Press and hold SET ACC/SET ACCEL. Release the control when the desired vehicle speed is reached or
- Press and release SET ACC/SET ACCEL. Each press will increase the set speed by 1.6 km/h (1 mph) or
- Accelerate with your accelerator pedal, then press and release SET ACC/SET ACCEL.

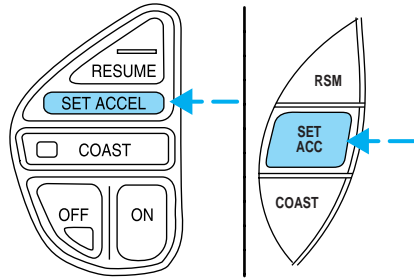

You can accelerate with the accelerator pedal at any time during speed control usage. Releasing the accelerator pedal will return your vehicle to the previously programmed set speed.

To set a lower set speed

- Press and hold CST/COAST. Release the control when the desired speed is reached or
- Press and release CST/COAST. Each press will decrease the set speed by 1.6 km/h (1 mph) or

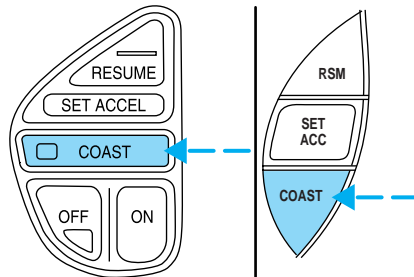

Controls and features

- Depress the brake pedal. When the desired vehicle speed is reached, press SET ACC/SET ACCEL.

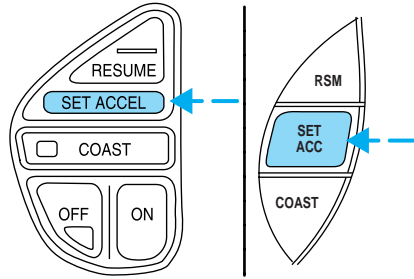

To disengage speed control

- Depress the brake pedal or

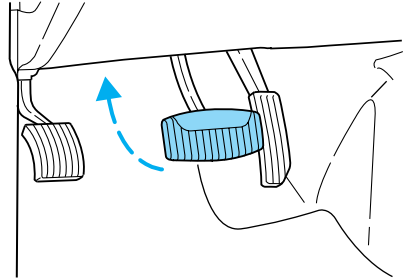

- Depress the clutch pedal (if equipped)

Disengaging the speed control will not erase the previously programmed set speed.

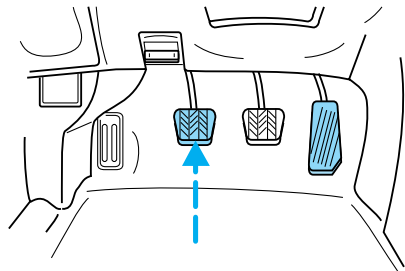

Controls and features

Pressing OFF will erase the previously programmed set speed.

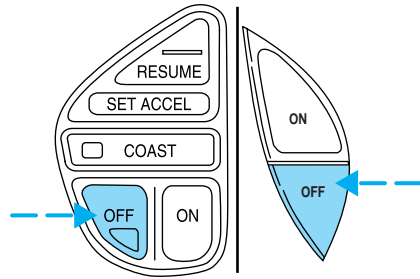

To return to a previously set speed

- Press RES/RSM/RESUME. For RES/RSM/RESUME to operate, the vehicle speed must be faster than 48 km/h (30 mph).

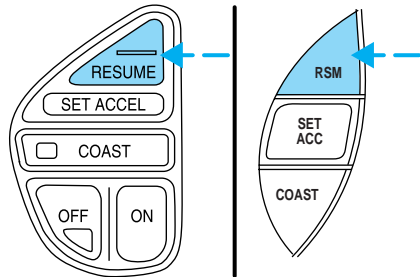

Indicator light

This light comes on when either the SET ACC/SET ACCEL or RES/RSM/RESUME controls are pressed. It turns off when the speed control OFF control is pressed, the brake is applied or the ignition is turned to the OFF position.

**SPEED
CONT**

TILT STEERING (IF EQUIPPED)

Pull the steering control toward you to move the steering wheel up or down. Hold the control while adjusting the wheel to the desired position, then release the control to lock the steering wheel in position.

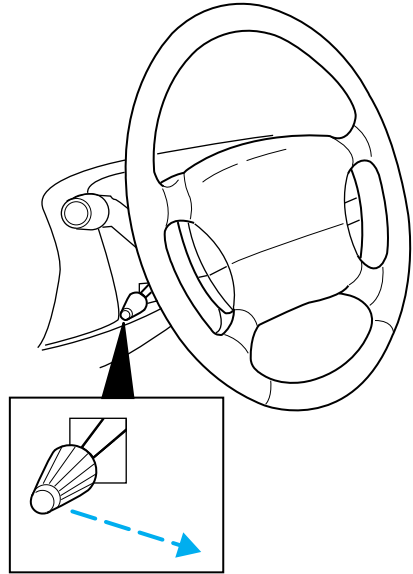

Never adjust the steering wheel when the vehicle is moving.

HAZARD FLASHER

For information on the hazard flasher control, refer to *Hazard lights control* in the *Roadside emergencies* chapter.

Controls and features

WINDSHIELD WIPER/WASHER CONTROLS

Rotate the windshield wiper control to the desired interval, low or high speed position.

The bars of varying length are for intermittent wipers. When in this position rotate the control upward for fast intervals and downward for slow intervals.

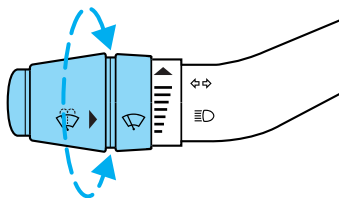

Push the control on the end of the stalk to activate washer. Push and hold for a longer wash cycle.

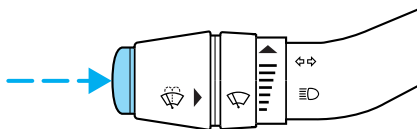

Speed dependent wipers

When the windshield wiper control is set on the intermittent settings, speed-sensitive front wipers automatically adjust as the vehicle's speed increases.

Rear window wiper and washer

Rear window wiper and washer (if equipped)

For rear wiper operation, rotate the rear window wiper and washer control to the desired interval position.

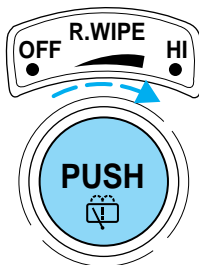

Controls and features

Press the control for rear washer fluid operation.

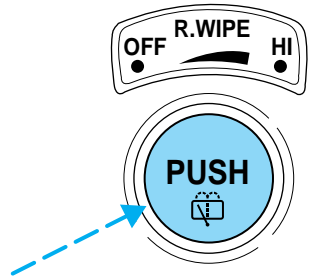

STEERING WHEEL CONTROLS (IF EQUIPPED)

These controls allow you to operate some radio and climate control features.

Radio control features

- Press MEM/NEXT to select a preset station from memory.
- Press BAND/MODE to select AM, FM1, FM2, TAPE or CD (if equipped).
- Press VOL up or down to adjust the volume.

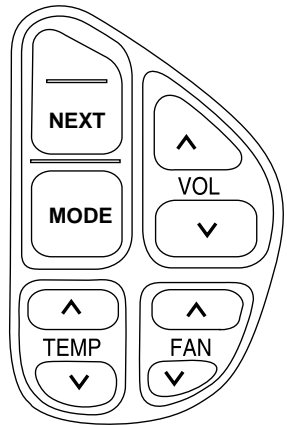

Climate control features

- Press TEMP up or down to adjust temperature.
- Press FAN up or down to adjust fan speed.

Controls and features

OVERHEAD CONSOLE (IF EQUIPPED)

The appearance of your vehicle's overhead console will vary according to your option package. All overhead consoles show the outside temperature and compass display.

Storage compartment (if equipped)

Press the OPEN control to open the storage compartment. The door will open slightly and can be moved to full open.

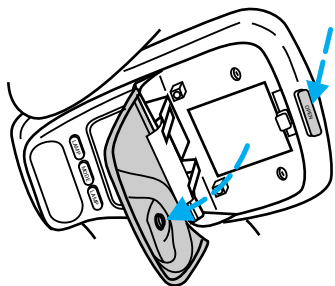

Installing a garage door opener (if equipped)

The storage compartment can be converted to accommodate a variety of aftermarket garage door openers:

- Remove the storage clip from the door.
- Place Velcro[™] hook onto side of aftermarket transmitter opposite of actuator control.
- Place the transmitter into storage compartment, control down.
- Place the provided height adaptors onto the back of the GARAGE control as needed.

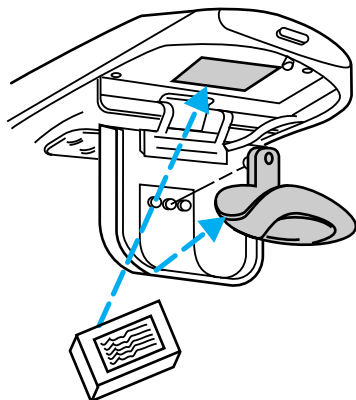

Controls and features

- Press the GARAGE control to activate the transmitter.

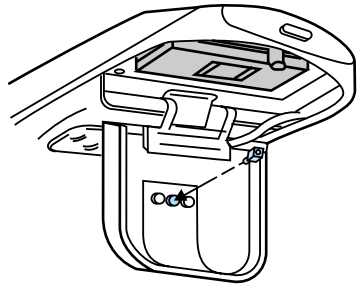

Moon roof (if equipped)

- Press and release the rear portion of the moon roof control to open.
- To halt motion at any point during one-touch opening, press the control a second time.
- Press and hold (as desired) the front portion of the moon roof control to close.

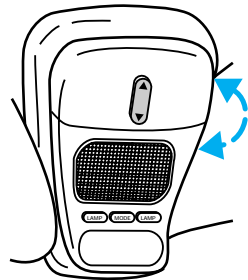

The moon roof has a sliding shade that can be manually opened or closed when the glass panel is shut. To close the shade, pull it toward the front of the vehicle.



Do not let children play with the moon roof. They may seriously hurt themselves.

Electronic compass/temperature display

A compass and outside temperature display are contained in the overhead console.

Controls and features

The compass and temperature display can be turned off and on by pressing the MODE control on the overhead console. The vehicle heading is displayed as one of N, NE, E, SE, S, SW, W and NW.

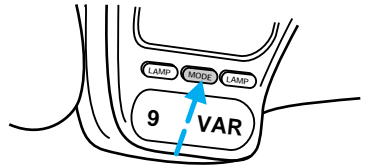

Outside air temperature

The temperature can be displayed in Centigrade or Fahrenheit by pressing the MODE control.

If the outside temperature falls below 3.3°C (38°F), the display will alternate from “ICE” to the outside temperature at a two second rate for one minute.

The compass reading may be affected when you drive near large buildings, bridges, power lines and powerful broadcast antenna. Magnetic or metallic objects placed in or on the vehicle may also affect compass accuracy. Adjustments may need to be made to the zone and calibration of the compass.

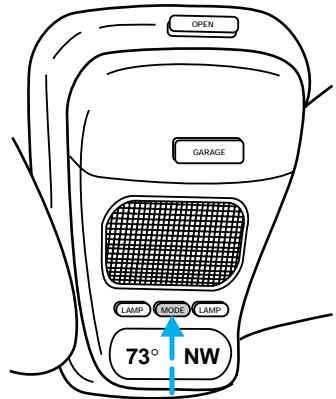

Controls and features

Compass zone adjustment

1. Determine which magnetic zone you are in by referring to the zone map.

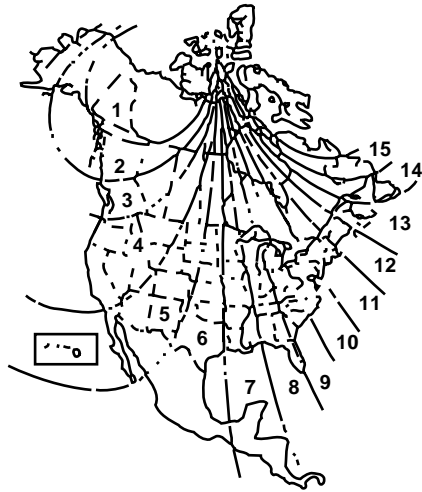

2. Press and hold the MODE control until VAR appears in the display, then release. The display should show the current zone number.

3. Press the MODE control until the desired zone number appears. The display will flash and then return to normal operation. The zone is now updated.

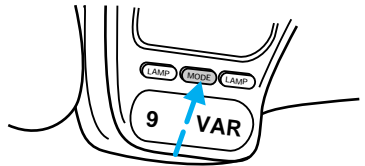

Controls and features

Compass calibration adjustment

Perform this adjustment in an open area free from steel structures and high voltage lines:

- Press and hold the MODE control until CAL appears in the display (approximately eight seconds) and release.
- Drive the vehicle slowly (less than 5 km/h [3 mph]) in circles until CAL indicator turns off in about 2–3 complete circles.

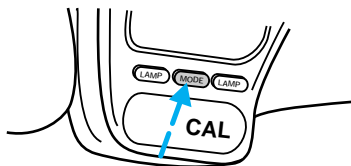

AUTOLAMP DELAY SYSTEM (IF EQUIPPED)

The autolamp sets the headlamps to turn on and off automatically. The autolamp may be set to:

- turn on the lamps automatically at night
- turn off the lamps automatically during daylight
- keep the lamps on for up to three minutes after the key is turned to OFF

Setting autolamp

1. Make sure the headlamp control is in the OFF position. Leaving the headlamp control on will override the autolamp.

2. Turn the ignition to the ON position or start the vehicle.

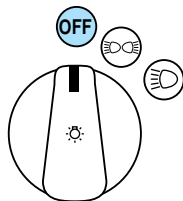

Controls and features

3. Slide the delay control all the way to the left.

The further you move the knob to the right, the longer the headlamps stay on after the ignition is turned to the OFF position. The autolamp will keep the headlamps on for a maximum of three minutes after the ignition is turned to OFF.

4. The autolamp automatically turns the lamps on and off. The indicator light will illuminate when the headlamps turn on.

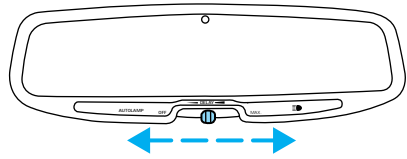

Automatic dimming rear view mirror

The autolamp/automatic dimming mirror is equipped with an automatic dimming feature. This feature will change from the normal state to the non-glare “active” state when bright lights (glare) reach the mirror. When the mirror detects bright light from front or behind, it will adjust automatically to minimize glare.

The mirror will automatically return to the normal position whenever the vehicle is placed in R (Reverse) (when the mirror is in the ON position). This helps to ensure a bright clear view in the mirror when backing up.

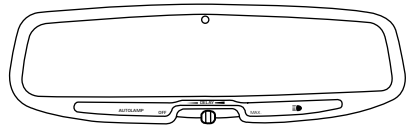

Controls and features

POWER WINDOWS (IF EQUIPPED)

Press and hold the rocker switches to open and close windows.

- Press the top portion of the rocker switch to close.

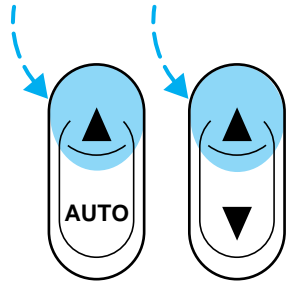

- Press the bottom portion of the rocker switch to open.

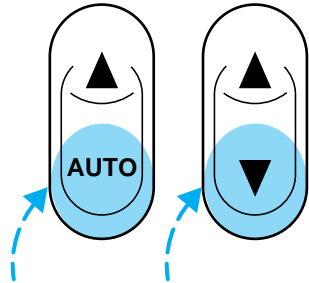

One touch down

- Press AUTO and release quickly. The window will open fully. Depress again to stop window operation.

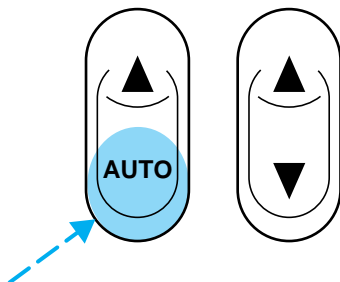

Window lock

The window lock feature allows only the driver to operate the power windows.

To lock out all the window controls except for the driver's press the right side of the control. Press the left side to restore the window controls.

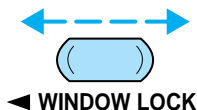

POWER DOOR LOCKS (IF EQUIPPED)

Press U to unlock all doors and L to lock all doors.

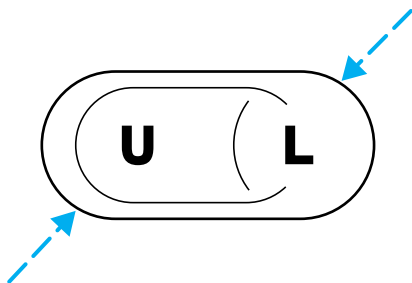

Controls and features

Two step unlocking (if equipped)

When unlocking the driver door with the key, turn it once toward the rear of the vehicle to unlock that door only. Turn the key to the rear a second time to unlock all doors.

If the vehicle is equipped with the optional perimeter alarm system, this feature will work from all doors.

CHILDPROOF DOOR LOCKS

When these locks are set, the rear doors cannot be opened from the inside. The rear doors can be opened from the outside when the doors are unlocked.

The childproof locks are located on rear edge of each rear door and must be set separately for each door. Setting the lock for one door will not automatically set the lock for both doors.

Move lock control up to engage the lock. Move control down to disengage childproof locks.

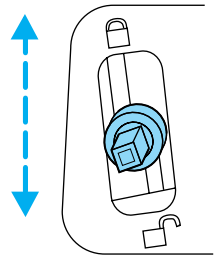

POWER SIDE VIEW MIRRORS (IF EQUIPPED)

To adjust your mirrors:

1. Select ◀ to adjust the left mirror or ▶ to adjust the right mirror.
2. Move the control in the direction you wish to tilt the mirror.

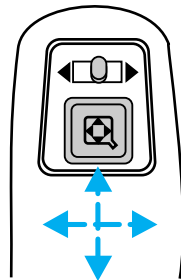

3. Return to the center position to lock mirrors in place.

Heated outside mirrors (if equipped)

Both mirrors are heated automatically to remove ice, mist and fog when the rear window defrost is activated.

Do not remove ice from the mirrors with a scraper or attempt to readjust the mirror glass if it is frozen in place. These actions could cause damage to the glass and mirrors.

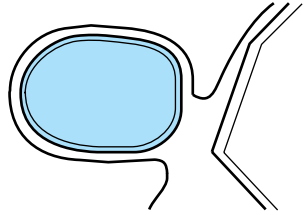

CENTER CONSOLE

Your vehicle may be equipped with a variety of console features. These include:

- utility compartment with cassette/compact disc storage
- auxiliary power point
- cupholders
- tissue box holder
- cellular phone (if equipped)
- ashtray or removable ashcup
- compact disc changer (if equipped)

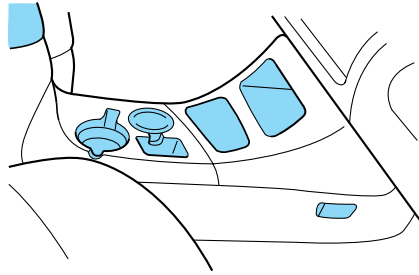

Use only soft cups in the cupholder. Hard objects can injure you in a collision.

Controls and features

Rear console features

The rear console incorporates the following features:

- air vents
- audio system controls
- rear seat climate controls
- cupholders

Refer to the “Audio Guide” for more information on the rear console audio system controls.

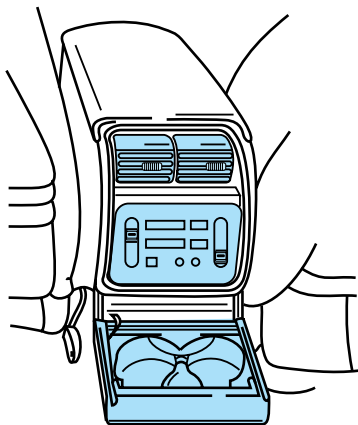

AUXILIARY POWER POINT

The power point is an additional power source for electrical accessories.

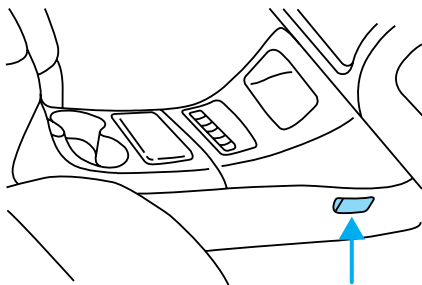

Controls and features

CENTER ARMREST/REAR CUPHOLDER

Do not attempt to raise the console armrest when the rear cupholder is in use. If you find resistance when raising the armrest, make sure the cupholder is **fully** closed or else damage may occur to the armrest.

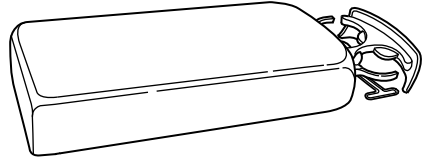

POSITIVE RETENTION FLOOR MAT

Position the floor mat so that the eyelet is over the pointed end of the retention post and rotate forward to lock in. Make sure that the mat does not interfere with the operation of the accelerator or the brake pedal. To remove the floor mat, reverse the installation procedure.

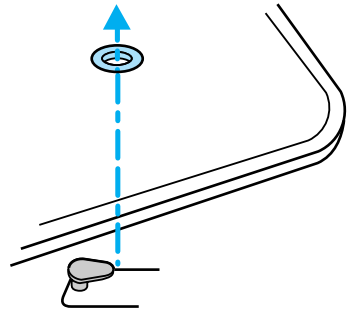

REAR LIFTGATE

The liftgate area is only intended for cargo, not passengers. You can open and close the liftgate from outside the vehicle. It cannot be opened from inside the cargo area.

Controls and features

- To open the liftgate window, unlock the liftgate (with the key or power door locks) and push the key lock cylinder.
- To open the liftgate, unlock the liftgate and pull up on the handle under the license plate lamp shield.

To lock the liftgate and the liftgate window, use the key or the power door locks, depress the key lock cylinder or press the door lock switch on the left side of the cargo area.

The liftgate door and window should be closed before driving your vehicle. If not, possible damage may occur to the liftgate door lift cylinders and attaching hardware.

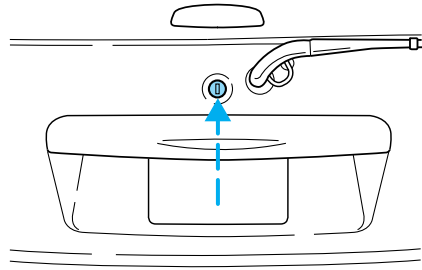

Make sure that the liftgate door and/or window are closed to prevent exhaust fumes from being drawn into the vehicle. This will also prevent passengers and cargo from falling out. If you must drive with the liftgate door or window open, keep the vents open so outside air comes into the vehicle.

CARGO COVER (IF EQUIPPED)

Your vehicle may be equipped with a cargo area shade that covers the luggage compartment of your vehicle.

To install the shade:

1. Fasten the cover into the mounting brackets (make sure the cover is right side up).
2. Pull the end of the shade toward you and hook the sides into the notches in the rear trim panels.

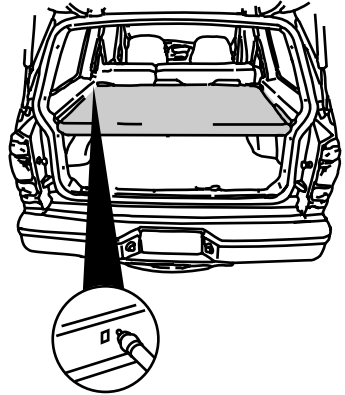

 To prevent the possibility of injuries, the fasteners for the cargo area cover must be properly attached to the mounting clips on the rear trim panels.

 Do not place any objects on the cargo area cover. They may obstruct your vision or strike occupants of the vehicle in the case of a sudden stop or collision.

Rewinding the shade

With extended use, the cargo shade may lose its spring tension. If this occurs, the shade must be manually rewound. This is a two-person operation.

1. Remove the shade from the vehicle and extend it with the smooth grain facing you.

Controls and features

2. Wrap the vinyl around the roller tube twice. Tuck the edges of the vinyl inside the end cap with each wrap.

3. Fold the edges of the vinyl towards the center, making sure that the edges clear the end cap slots. Use tape or a rubber band to hold the vinyl to the left side of the tube.

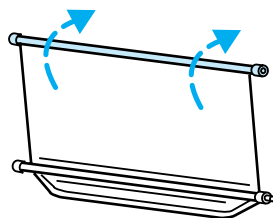

4. Push in the right end cap (marked RH) about $\frac{1}{4}$ of the total length to disengage the clutch and hold the end cap in while turning the roller tube toward you 14 times.

5. Let go of the right end cap. The clutch will now engage and stop the shade from losing its spring tension.

6. Unfold the vinyl and place it into the end cap slots.

7. Insert the shade into the side mounting brackets and check to make sure that it operates properly.

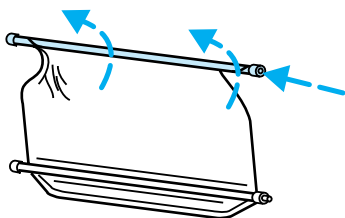

The cover may cause injury in a sudden stop or accident if it is not securely installed.

REMOTE ENTRY SYSTEM

The remote entry system allows you to lock or unlock all vehicle doors without a key.

The remote entry features only operate with the ignition in the OFF position.

Unlocking the doors

Press this control to unlock the driver door. The interior lamps will illuminate.

Press the control a second time within five seconds to unlock all doors.

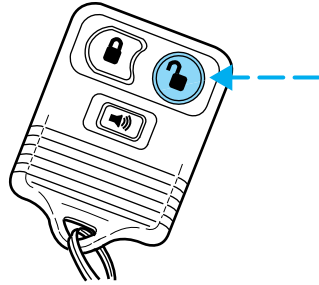

Locking the doors

Press this control to lock all doors.

To confirm all doors are closed and locked, press the control a second time within five seconds. The doors will lock again, the horn will chirp and the lamps will flash.

If any of the doors are ajar, the horn will make two quick chirps, reminding you to properly close all doors.

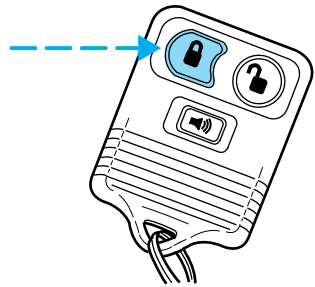

Controls and features

Sounding a panic alarm

Press this control to activate the alarm.

To deactivate the alarm, press the control again or turn the ignition to ACC or ON.

This device complies with part 15 of the FCC rules and with RS-210 of Industry Canada. Operation is subject to the following two conditions: (1) This device may not cause harmful interference, and (2) This device must accept any interference received, including interference that may cause undesired operation.

Changes or modifications not expressly approved by the party responsible for compliance could void the user's authority to operate the equipment.

Memory seat feature (if equipped)

The remote entry system can also control the memory seat feature.

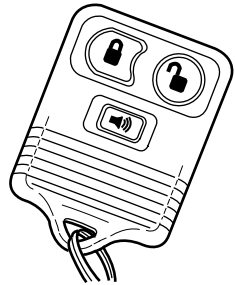
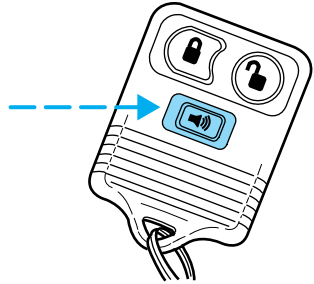

Controls and features

Press the control once to unlock the driver's door and move the memory seat feature to the corresponding memory position, just as if you had pressed the memory control in the vehicle.

When your dealer programs new transmitters:

- the first transmitter programmed will recall memory position one.
- the second transmitter programmed will recall memory position two.
- the third transmitter programmed recall memory position three.
- the fourth transmitter programmed will not recall a memory position.

Memory positions can be changed at any time. The memory feature can be deactivated or reactivated by performing the following:

1. Make sure the alarm system (if equipped) is not armed or triggered, the ignition is off and all doors and the liftgate window are closed.
2. Turn the ignition key from OFF to ON.
3. Press the power door unlock control three times.
4. Turn the ignition key from ON to OFF.
5. Press the power door unlock control three times.
6. Turn the ignition switch back to ON. The horn will chirp.
7. Press the power door unlock switch twice.
8. Press the unlock control two times, then press the lock control. The horn will chirp twice if the remote memory seat feature was deactivated or will sound three times (two short chirps followed by one long chirp) if the feature was activated.
9. Turn the ignition to OFF. The horn will chirp once to confirm that you activated or deactivated the remote memory seat feature.

The memory feature will continue to work from the door switch even when deactivated at the remote entry module.

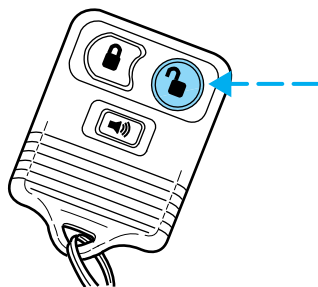

Controls and features

Replacing the battery

The transmitter is powered by one coin type three-volt lithium battery CR2032 or equivalent. Typical operating range will allow you to be up to 10 meters (33 feet) away from your vehicle. A decrease in operating range can be caused by:

- battery weakness due to time and use
- weather conditions
- nearby radio towers
- structures around the vehicle
- other vehicles parked next to the vehicle

To replace the battery:

1. Twist a thin coin between the two halves of the transmitter near the key ring. **DO NOT TAKE THE FRONT PART OF THE TRANSMITTER APART.**
2. Place the positive (+) side of new battery in the same orientation. Refer to the diagram inside the transmitter unit.
3. Snap the two halves back together.

Replacing lost transmitters

Take all your vehicle's transmitters to your dealer for reprogramming if:

- a transmitter is lost or
- you want to purchase additional transmitters (up to four may be programmed).

To reprogram the transmitters, place the key in the ignition and switch from OFF to ON five times in rapid succession (within 10 seconds). After doors lock/unlock, press any button on all transmitters (up to four). When completed, switch the ignition to OFF. All transmitters must be programmed at the same time.

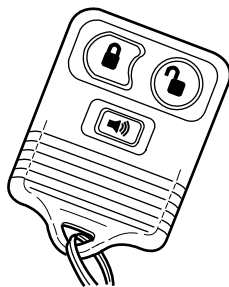

Reprogramming transmitters

To reprogram all transmitters, place the key in the ignition and switch from OFF to ON eight times in a row (within 10 seconds). After doors lock/unlock, press any button on all transmitters (up to four). When completed, switch the ignition to OFF.

All transmitters must be reprogrammed at the same time.

Illuminated entry

The interior lamps and the puddle lamps (located on the bottom of the exterior rear view mirrors) illuminate when the remote entry system is used to unlock the door(s) or sound the personal alarm.

The system automatically turns off after 25 seconds or when the ignition is turned to the START or ACC position. The dome lamp switch (if equipped) must **not** be set to the OFF position for the illuminated entry system to operate.

The inside lights will not turn off if:

- they have been turned on with the dimmer control or
- any door is open.

Battery saver will shut off the interior lamps 45 minutes after the last door is closed.

Autolock

Autolock is a feature that will automatically lock all doors when:

- all vehicle doors, liftgate and liftgate window are fully closed
- the ignition key is in the ON position
- you shift into or through R (Reverse)
- the brake pedal is released

The autolock feature repeats when:

- any door is opened and then closed
- the brake pedal is released

Deactivating autolock

Before following the activation or deactivation procedures, make sure that the anti-theft system is not armed, the ignition is OFF and all vehicle doors and liftgate window are closed.

Controls and features

1. Enter the 5 digit entry code.
2. Press and release the 3/4 control while holding the 7/8 control.
3. Release the 7/8 control.

The horn will chirp once if autolock was deactivated or twice (one short and one long chirp) if autolock was activated.

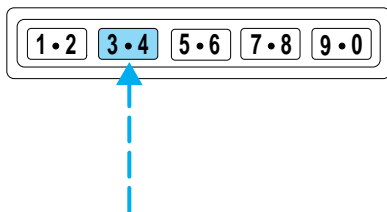

To reactivate autolock, repeat steps 1 through 3.

Autolock can also be activated or deactivated using the following procedure:

You must complete steps 1 through 5 within 30 seconds or the procedure will have to be repeated. If the procedure needs to be repeated, you must wait 30 seconds.

1. Turn the ignition key to ON.
2. Press the power door unlock control three times.
3. Turn the ignition key from ON to OFF.
4. Press the power door unlock control three times.
5. Turn the ignition key back to ON. The doors will lock and unlock.
6. Press the power door unlock switch. The horn will chirp once upon successful toggling of the Autolock feature.
7. Turn ignition to OFF. The horn will chirp to confirm procedure is complete.

Keyless entry system (if equipped)

With the keyless entry keypad, you can:

- lock or unlock the vehicle doors without using the key
- arm and disarm the perimeter alarm system (if equipped)
- activate/deactivate the autolock feature

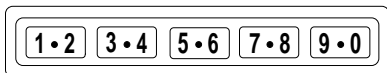

Controls and features

See also *Remote entry system* and *Perimeter alarm system* in this chapter for more information.

Your vehicle has a factory-set 5 digit code that operates the keyless entry system. You can also program your own 5 digit personal entry code.

The factory-set code is located:

- on the owner's wallet card in the glove compartment
- taped to the computer module

When pressing the controls on the keyless entry keypad, press the middle of the buttons to ensure a good activation.

Programming your own personal entry code

1. Enter the factory-set code (keypad will illuminate when pressed).
2. Press the 1/2 control within five seconds of step 1.
3. Enter your personal 5 digit code. Enter each digit within five seconds of the previous one.

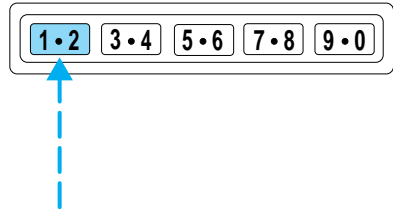

Do not set a code that includes five of the same number or presents them in sequential order. Thieves can easily figure out these types of codes.

Your personal code does not replace the permanent code that the dealership gave you. You can use either code to unlock your vehicle. If a second personal code is entered, the module will erase the first personal code in favor of the new code.

If you wish to erase your personal code, use the following instructions:

Controls and features

Erasing personal code

1. Enter the factory-set code.
2. Press 1/2 within five seconds of step one.
3. Press the 7/8 and 9/0 controls at the same time within five seconds of step two.

The system will now only respond to the factory-set code.

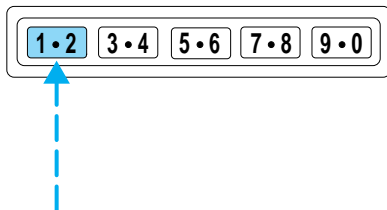

Unlocking the doors with the keyless entry system

To unlock the driver's door, enter either the factory-set code or personal code (each digit pressed within 5 seconds of the prior digit). The interior lamps will illuminate.

To unlock all doors, enter the factory-set code or personal code (driver door unlocks) and press the 3/4 control within 5 seconds.

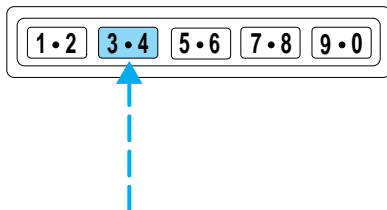

Locking the doors with the keyless entry system

To lock all the doors, press 7/8 and 9/0 at the same time. It is not necessary to first enter the keypad code.

This will arm your perimeter alarm system (if equipped). Refer to *Perimeter alarm system* in this chapter for more information.

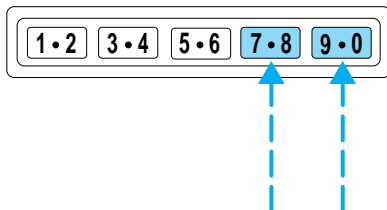

Controls and features

Operating your perimeter alarm system (if equipped) from the keyless entry pad

The keyless entry system arms by pressing 7/8 and 9/0.

To disarm or reset a triggered alarm, enter the five digit code.

All doors must be fully closed for the alarm system to arm. Refer to the *Perimeter alarm system* section, if equipped, in this chapter for more details.

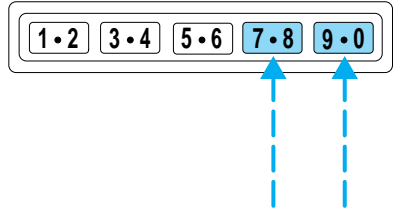

PERIMETER ALARM SYSTEM (IF EQUIPPED)

Arming the system

When armed, this system will help protect your vehicle from unauthorized entry. When unauthorized entry occurs, the system will flash the headlamps, parking lamps and the theft indicator lamp and will chirp the horn.

The system is ready to arm whenever the ignition is turned OFF. Any of the following actions will prearm the alarm system:

- Press the remote entry lock control
- Open a door and press the power door lock control to lock the doors

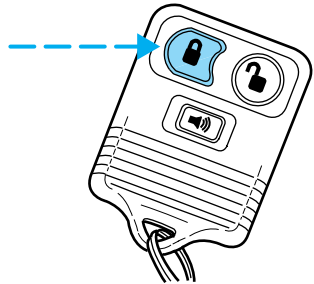

Controls and features

- Pressing 7/8 and 9/0 on the keyless entry pad at the same time to lock the doors (doors opened or closed).

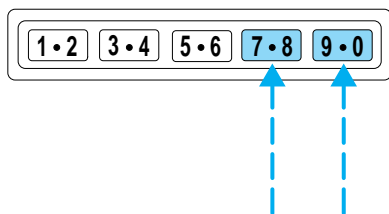

If a door is open, the system is prearmed and is waiting for the door to close. The theft indicator on the instrument cluster will be lit continuously when the system is prearmed.

Once the doors are closed, the system will arm in 30 seconds.

When you press the lock control twice within 5 seconds, the horn will chirp once to let you know that the system is armed.

If the doors are not closed and you press the remote entry transmitter twice to confirm the doors are locked, the horn will chirp twice to warn you that the system is not arming.

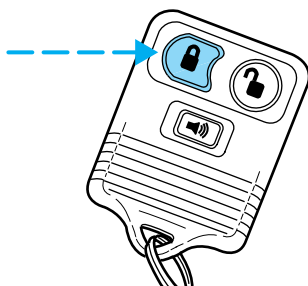

Controls and features

Disarming the system

You can disarm the system by any of the following actions:

- Unlock the doors by using your remote entry transmitter.

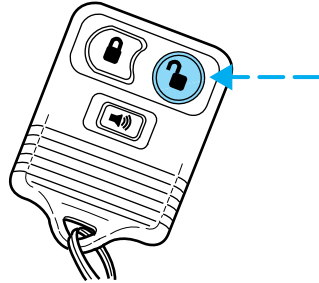

- Unlock the doors with a key. Turn the key full travel (toward the front of the vehicle) to make sure the alarm disarms.
- Unlock the doors by using your keyless entry keypad.
- Turn ignition to ACC or ON.
- Press the panic control on the remote entry transmitter. This will disarm the system only if the alarm is sounding.

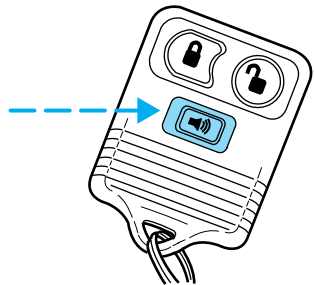
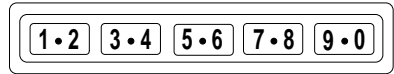

SecuriLock™ anti-theft system

The SecuriLock™ anti-theft system provides an advanced level of vehicle theft protection. Your vehicle's engine can only be started with the two

Controls and features

special SecuriLock™ electronically coded keys provided with your vehicle. Each time you start your vehicle, the SecuriLock™ key is read by the SecuriLock™ anti-theft system. If the SecuriLock™ key identification code matches the code stored in the SecuriLock™ anti-theft system, the vehicle's engine is allowed to start. If the SecuriLock™ key identification code does not match the code stored in the system or if a SecuriLock™ key is not detected (vehicle theft situation), the vehicle's engine will not operate.

Spare SecuriLock™ keys can be purchased from your dealership and programmed to your SecuriLock™ anti-theft system. Refer to *Programming spare SecuriLock™ keys* for more information.

If one or both of your SecuriLock™ keys are lost or stolen and you want to ensure the lost or stolen key will not operate your vehicle, bring your vehicle and all available SecuriLock™ keys to your dealership for reinitialization.

Theft indicator

The theft indicator on the instrument cluster will operate as follows:

- When the ignition is OFF, the theft indicator will flash briefly every 2 seconds to indicate the SecuriLock™ system is protecting your vehicle.
- When the ignition is turned to RUN or START, the theft indicator will light for 3 seconds and then go out. If the theft indicator stays on for an extended period of time or flashes rapidly, have the system serviced by your dealership or a qualified technician.

Programming spare SecuriLock™ keys

Spare SecuriLock™ keys can be purchased from your dealership and programmed to your SecuriLock™ anti-theft system (up to a total of 8 keys). Your dealership can program your new SecuriLock™ key(s) to your vehicle or you can do it yourself using the following simple procedure. To program a new SecuriLock™ key yourself, you will need two previously programmed SecuriLock™ keys (keys that already operate your vehicle's engine). If two previously programmed SecuriLock™ keys are not available (one or both of your original keys were lost or stolen), you must bring your vehicle to your dealership to have the spare SecuriLock™ key(s) programmed.

Procedure to program spare SecuriLock™ keys to your vehicle

New SecuriLock™ keys must have the correct mechanical key cut for your vehicle.

Conventional (non-SecuriLock™) keys **cannot** be programmed to your vehicle.

You will need to have two previously programmed SecuriLock™ keys and the new unprogrammed SecuriLock™ key readily accessible for the procedure. Please read and understand the entire procedure before you begin.

1. Insert the first previously programmed SecuriLock™ key into the ignition switch and turn the ignition from OFF to RUN (maintain ignition in RUN for at least one second).
2. Turn ignition to OFF and remove the first SecuriLock™ key from the ignition switch.
3. Within five seconds of turning the ignition to OFF, insert the second previously programmed SecuriLock™ key into the ignition switch and turn the ignition from OFF to RUN (maintain ignition in RUN for at least one second but no more than 5 seconds).
4. Turn the ignition to OFF and remove the second SecuriLock™ key from the ignition switch.
5. Within 10 seconds of turning the ignition to OFF, insert the unprogrammed SecuriLock™ key (new key) into the ignition switch and turn the ignition from OFF to RUN (maintain ignition switch in RUN for at least one second). This step will program your new SecuriLock™ key.
6. If it is desired to program additional SecuriLock™ key(s), repeat this procedure from step 1.

If the programming procedure was successful, the new SecuriLock™ key(s) will start the vehicle's engine. The theft indicator (located on the instrument cluster) will light for three seconds and then go out.

If the programming procedure was not successful, the new SecuriLock™ key(s) will not operate the vehicle's engine. The theft indicator will flash on and off. Wait at least one minute and then repeat the procedure from step 1. If failure repeats, bring your vehicle to your dealership to have the spare SecuriLock™ key(s) programmed.

Seating and safety restraints

SEATING

Adjusting the front power seat (if equipped)



Never adjust the driver's seat or seatback when the vehicle is moving.



Do not pile cargo higher than the seatbacks to avoid injuring people in a collision or sudden stop.



Always drive and ride with your seatback upright and the lap belt snug and low across the hips.

Press to raise or lower the front portion of the seat cushion.

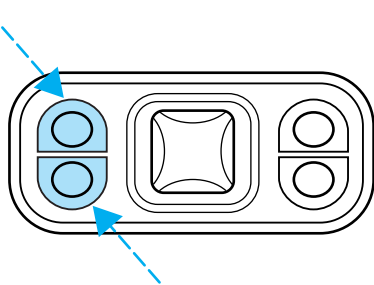

Press to raise or lower the rear portion of the seat cushion.

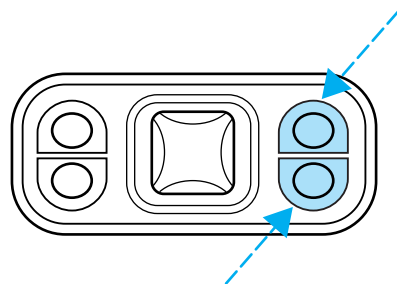

Seating and safety restraints

Press the control to move the seat forward, backward, up or down.

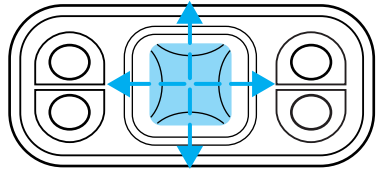

Memory seats (if equipped)

This system allows automatic positioning of the driver seat and outside rearview mirrors to three programmable positions.

The memory seat control is located on the driver door.

- To program position one, move the driver seat to the desired position using the seat controls. Press the SET control. The SET control indicator light will briefly illuminate. While the light is illuminated, press control 1.
- To program position two, repeat the previous procedure using control 2.
- To program position three, repeat the previous procedure but press controls 1 and 2 simultaneously.

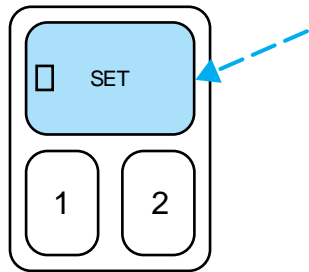

A position can only be set or recalled when the transmission gearshift is in Park or Neutral. A memory seat position may be programmed at any time.

The memory seat positions are also recalled when you press your remote entry transmitter UNLOCK control.

To program the memory seat to remote entry transmitter, refer to *Remote entry system* in the *Controls and features chapter*.

Seating and safety restraints

Using the power lumbar support

The power lumbar control is located on the outboard side of the seat.

Press one side of the control to adjust firmness.

Press the other side of the control to adjust softness.

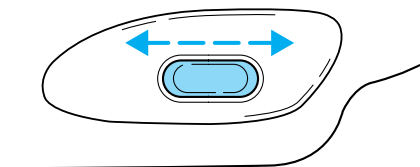

REAR SEATS

Head restraints

Push or pull the head rests to the desired position.

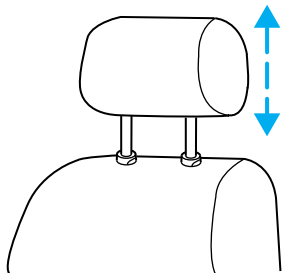

Seating and safety restraints

Folding rear seats (if equipped)

If your vehicle is equipped with a built-in child seat, the seatback cannot be folded down unless the built-in child seat is fully stowed.

1. Press the lower release control downward to unlatch the seatback.
2. Rotate the seatback downward into the load floor position.
3. Press down on the top outboard area of the seatback until a click is heard. The seat is now latched in the floor position.

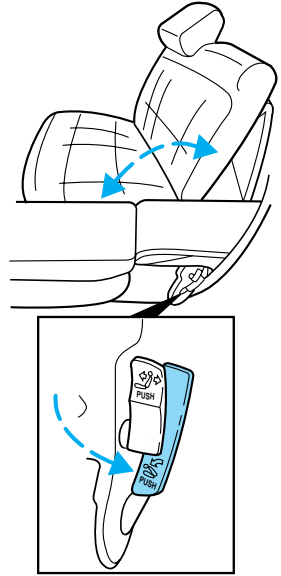

Seating and safety restraints

To return the seat to the upright position:

- Press downward on the upper corner of the seatback and hold.
- Pull the release handle upward to unlatch the seat.
- Rotate the seatback upward until the seatback latches in the upright position. The seatback will click when it is locked into position.

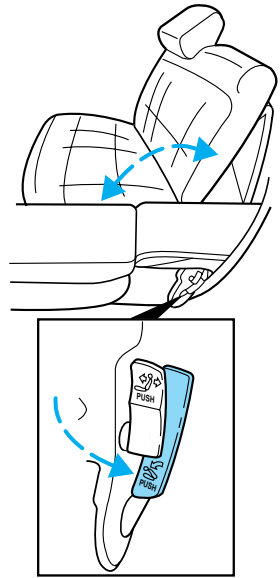

SAFETY RESTRAINTS

Safety restraints precautions



Always drive and ride with your seatback upright and the lap belt snug and low across the hips.



To prevent the risk of injury, make sure children sit where they can be properly restrained.



Never let a passenger hold a child on his or her lap while the vehicle is moving. The passenger cannot protect the child from injury in a collision.

Seating and safety restraints



All occupants of the vehicle, including the driver, should always wear their safety belts.



It is extremely dangerous to ride in a cargo area, inside or outside of a vehicle. In a collision, people riding in these areas are more likely to be seriously injured or killed. Do not allow people to ride in any area of your vehicle that is not equipped with seats and safety belts. Be sure everyone in your vehicle is in a seat and using a safety belt properly.



Each seating position in your vehicle has a specific safety belt assembly which is made up of one buckle and one tongue that are designed to be used as a pair. 1) Use the shoulder belt on the outside shoulder only. Never wear the shoulder belt under the arm. 2) Never swing it around your neck over the inside shoulder. 3) Never use a single belt for more than one person.

Combination lap and shoulder belts

1. To fasten, insert the tongue into the slot in the buckle.

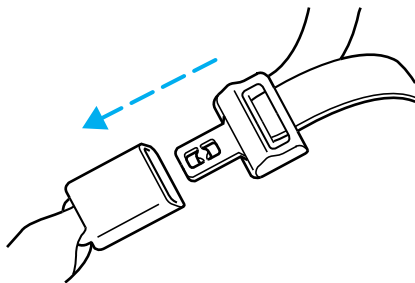

Seating and safety restraints

2. To unfasten, push the red release button and remove the tongue from the buckle.

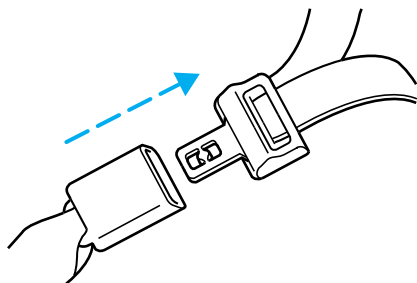

The front and rear outboard safety restraints in the vehicle are combination lap and shoulder belts. The front and rear seat passenger outboard safety belts have two types of locking modes described below:

Vehicle sensitive mode

The vehicle sensitive mode is the normal retractor mode, allowing free shoulder belt length adjustment to your movements and locking in response to vehicle movement. For example, if the driver brakes suddenly or turns a corner sharply, or the vehicle receives an impact of 8 km/h (5 mph) or more, the combination safety belts will lock to help reduce forward movement of the driver and passengers.

Automatic locking mode

In this mode, the shoulder belt is automatically pre-locked. The belt will still retract to remove any slack in the shoulder belt.

The automatic locking mode is not available on the driver safety belt.

When to use the automatic locking mode

- When a tight lap/shoulder fit is desired.
- **Anytime** a child safety seat is installed in the vehicle. Refer to *Safety Restraints for Children* or *Safety Seats for Children* later in this chapter.

Seating and safety restraints

How to use the automatic locking mode

- Buckle the combination lap and shoulder belt.

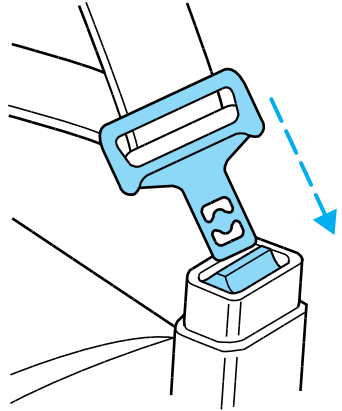

- Grasp the shoulder portion and pull downward until the entire belt is extracted.



- Allow the belt to retract. As the belt retracts, you will hear a clicking sound. This indicates the safety belt is now in the automatic locking mode.

How to disengage the automatic locking mode

Disconnect the combination lap/shoulder belt and allow it to retract completely to disengage the automatic locking mode and activate the vehicle sensitive (emergency) locking mode.

Seating and safety restraints

Front safety belt height adjustment

Your vehicle has safety belt height adjustments for the driver and front passenger. Adjust the height of the shoulder belt so the belt rests across the middle of your shoulder.

To lower the shoulder belt height, push the button and slide the height control down. To raise the height of the shoulder belt, slide the height adjuster up. Pull down on the height adjustment assembly to make sure it is locked in place.

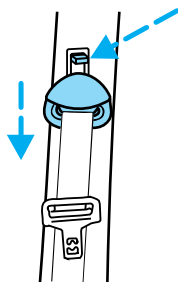

Position the shoulder belt height adjuster so that the belt rests across the middle of your shoulder. Failure to adjust the safety belt properly could reduce the effectiveness of the safety belt and increase the risk of injury in a collision.

Safety belt extension assembly

If the safety belt assembly is too short, even when fully extended, 20 cm (8 inches) can be added to the safety belt assembly by adding a safety belt extension assembly (part number 611C22). Safety belt extension assemblies can be obtained from your dealer at no cost.

Use only extensions manufactured by the same supplier as the safety belt. Manufacturer identification is located at the end of the webbing on the label. Also, use the safety belt extension only if the safety belt is too short for you when fully extended. Do not use extensions to change the fit of the shoulder belt across the torso.

Safety belt warning light and indicator chime

The seat belt warning light illuminates in the instrument cluster and a chime sounds to remind the occupants to fasten their safety belts.

Seating and safety restraints

Conditions of operation

If...	Then...
The driver's safety belt is not buckled before the ignition key is turned to ON...	The safety belt warning light illuminates for one to two minutes and the warning chime sounds for four to eight seconds.
The driver's safety belt is buckled while the indicator light is illuminated and the warning chime is sounding...	The safety belt warning light and warning chime turn off.
The driver's safety belt is buckled before the ignition key is turned to ON...	The safety belt warning light and indicator chime remain off.

Safety belt maintenance

Check the safety belt systems periodically to make sure they work properly and are not damaged. Check the safety belts to make sure there are no nicks, wears or cuts. All safety belt assemblies, including retractors, buckles, front seat belt buckle assemblies (slide bar)(if equipped), shoulder belt height adjusters (if equipped), child safety seat tether bracket assemblies (if equipped), and attaching hardware, should be inspected after a collision. Ford recommends that all safety belt assemblies used in vehicles involved in a collision be replaced. However, if the collision was minor and a qualified technician finds that the belts do not show damage and continue to operate properly, they do not need to be replaced. Safety belt assemblies not in use during a collision should also be inspected and replaced if either damage or improper operation is noted.



Failure to replace the safety belt assembly under the above conditions could result in severe personal injuries in the event of a collision.

Refer to *Cleaning and maintaining the safety belts* in the *Maintenance and care* section.

Seating and safety restraints

AIR BAG SUPPLEMENTAL RESTRAINT SYSTEM (SRS)

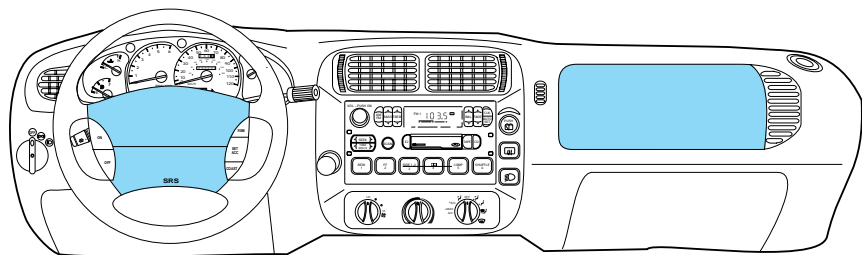

Important supplemental restraint system (SRS) precautions

The supplemental restraint system is designed to:

- work with the safety belt to protect the driver and right front passenger.
- reduce certain upper body injuries.

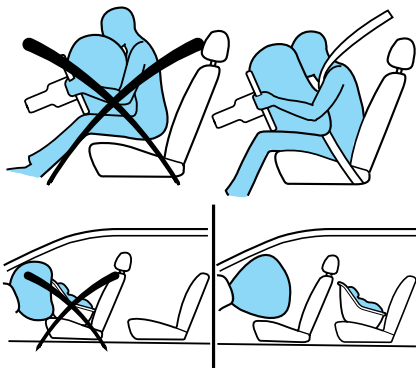

Failure to follow these instructions will affect the performance of the safety belts and increase the risk of personal injury.



The right front passenger air bag is not designed to restrain occupants in the center front seating position.

Seating and safety restraints



All occupants of the vehicle including the driver should always wear their safety belts even when air bag SRS is provided.



Do not place objects or mount equipment on or near the air bag cover on the steering wheel or in front seat areas that may come into contact with a deploying air bag. Failure to follow this instruction may increase the risk of personal injury in the event of a collision.



Do not attempt to service, repair, or modify the Air Bag Supplemental Restraint System or its fuses. See your Ford or Lincoln-Mercury dealer.

Children and air bags

For additional important safety information, read all information on safety restraints in this guide.

Children should always wear their safety belts. Failure to follow these instructions may increase the risk of injury in a collision.



Air bag can kill or injure a child in a child seat. If you must use a forward-facing child seat in the front seat, move seat all the way back.

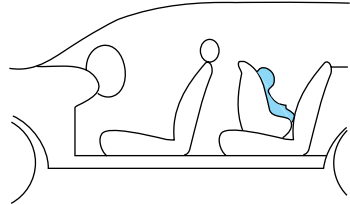
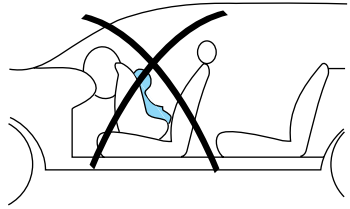

Seating and safety restraints

How does the air bag supplemental restraint system work?

The SRS is designed to activate when the vehicle sustains sufficient longitudinal deceleration.

The fact that the air bags did not inflate in a collision does not mean that something is wrong with the system. Rather, it means the forces were not of the type sufficient to cause activation.

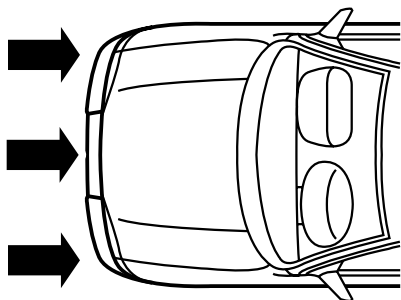

The air bags inflate and deflate rapidly upon activation.

After air bag deployment, it is normal to notice a smoke-like, powdery residue or smell the burnt propellant. This may consist of cornstarch, talcum powder (to lubricate the bag) or sodium compounds (e.g., baking soda) that result from the combustion process that inflates the air bag. Small amounts of sodium hydroxide may be present which may irritate the skin and eyes, but none of the residue is toxic.



Several air bag system components get hot after inflation. Do not touch them after inflation.

Seating and safety restraints



If the air bag is inflated, **the air bag will not function again and must be replaced immediately**. If the air bag is not replaced, the unrepaired area will increase the risk of injury in a collision.

The SRS consists of:

- driver and passenger air bag modules (which include the inflators and air bags),
- one or more impact and safing sensors,
- a readiness light and tone
- and the electrical wiring which connects the components.

The diagnostic module monitors its own internal circuits and the supplemental air bag electrical system warning (including the impact sensors), the system wiring, the air bag system readiness light, the air bag back up power and the air bag ignitors.

Determining if the system is operational

The SRS uses a readiness light in the instrument cluster or a tone to indicate the condition of the system. Refer to the *Air bag readiness* section in the *Instrumentation* chapter. Routine maintenance of the air bag is not required.

A difficulty with the system is indicated by one or more of the following:

- The readiness light will either flash or stay lit.
- The readiness light will not illuminate immediately after ignition is turned on.



- A series of five beeps will be heard. The tone pattern will repeat periodically until the problem and light are repaired.

If any of these things happen, even intermittently, have the SRS serviced at your dealership or by a qualified technician immediately. Unless serviced, the system may not function properly in the event of a collision.

Seating and safety restraints

Disposal of air bags and air bag equipped vehicles

For disposal of air bags or air bag equipped vehicles, see your local dealership or qualified technician. Air bags **MUST BE** disposed of by qualified personnel.

SAFETY RESTRAINTS FOR CHILDREN

Important child restraint precautions

You are required by law to use safety restraints for children in the U.S. and Canada. If small children ride in your vehicle (generally children who are four years old or younger and who weigh 18 kg [40 lbs] or less), you must put them in safety seats made especially for children. Check your local and state or provincial laws for specific requirements regarding the safety of children in your vehicle.



Never let a passenger hold a child on his or her lap while the vehicle is moving. The passenger cannot protect the child from injury in a collision.

Always follow the instructions and warnings that come with any infant or child restraint you might use.

When possible, place children in the rear seat of your vehicle. Accident statistics suggest that children are safer when properly restrained in the rear seating positions than in the front seating position.

Children and safety belts

Children who are too large for child safety seats (as specified by your child safety seat manufacturer) should always wear safety belts.

Follow all the important safety restraint and air bag precautions that apply to adult passengers in your vehicle.

If the shoulder belt portion of a combination lap and shoulder belt can be positioned so it does not cross or rest in front of the child's face or neck, the child should wear the lap and shoulder belt. Moving the child closer to the center of the vehicle may help provide a good shoulder belt fit.

If the shoulder belt cannot be properly positioned:

- move the child to one of the seats with a lap belt only (if equipped) or
- if the child is the proper size, restrain the child in a safety seat.

Seating and safety restraints



Do not leave children, unreliable adults, or pets unattended in your vehicle.

To improve the fit of lap and shoulder belts on children who have outgrown child safety seats, Ford recommends use of a belt-positioning booster seat that is labelled as conforming to all Federal motor vehicle safety standards. Belt-positioning booster seats raise the child and provide a shorter, firmer seating cushion that encourages safer seating posture and better fit of lap and shoulder belts on the child.

A belt-positioning booster should be used if the shoulder belt rests in front of the child's face or neck, or if the lap belt does not fit snugly on both thighs, or if the thighs are too short to let the child sit all the way back on the seat cushion when the lower legs hang over the edge of the seat cushion. You may wish to discuss the special needs of your child with your pediatrician.

SAFETY SEATS FOR CHILDREN

Child and infant or child safety seats

Use a safety seat that is recommended for the size and weight of the child. Carefully follow all of the manufacturer's instructions with the safety seat you put in your vehicle. If you do not install and use the safety seat properly, the child may be injured in a sudden stop or collision.

When installing a child safety seat:

- Use the correct safety belt buckle for that seating position.
- Make sure the tongue is securely fastened in the buckle.
- Keep the buckle release button pointing up and away from the safety seat, with the tongue between the child seat and the release button, to prevent accidental unbuckling.
- Place seat back in upright position.

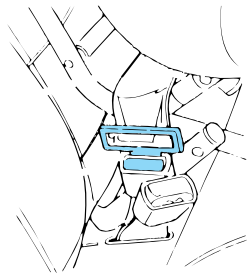

Seating and safety restraints

- Put the safety belt in the automatic locking mode. Refer to *Automatic locking mode*.

Ford recommends the use of a child safety seat having a top tether strap. Install the child safety seat in a seating position which is capable of providing a tether anchorage. For more information on top tether straps, refer to *Attaching safety seats with tether straps*.



Carefully follow all of the manufacturer's instructions included with the safety seat you put in your vehicle. If you do not install and use the safety seat properly, the child may be injured in a sudden stop or collision.

Installing child safety seats in combination lap and shoulder belt seating positions

1. Position the child safety seat in a seat with a combination lap and shoulder belt.



Air bag can kill or injure a child in a child seat. If you must use a forward-facing child seat in the front seat, move seat all the way back.

Seating and safety restraints

2. Pull down on the shoulder belt and then grasp the shoulder belt and lap belt together.

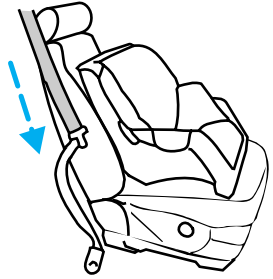

3. While holding the shoulder and lap belt portions together, route the tongue through the child seat according to the child seat manufacturer's instructions. Be sure the belt webbing is not twisted.

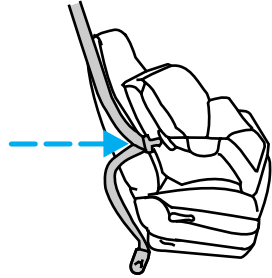

4. Insert the belt tongue into the proper buckle for that seating position until you hear and feel the latch engage. Make sure the tongue is latched securely by pulling on it.

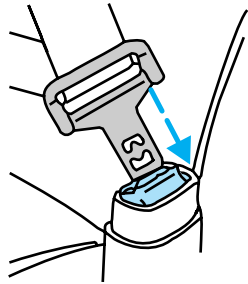

Seating and safety restraints

5. To put the retractor in the automatic locking mode, grasp the shoulder portion of the belt and pull downward until all of the belt is extracted and a click is heard.

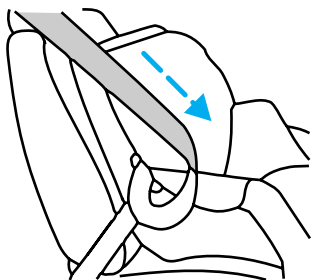

6. Allow the belt to retract. The belt will click as it retracts to indicate it is in the automatic locking mode.

7. Pull the lap belt portion across the child seat toward the buckle and pull up on the shoulder belt while pushing down with your knee on the child seat.

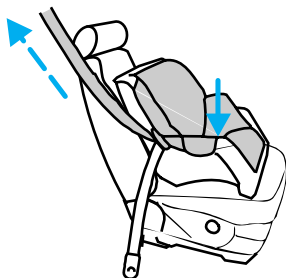

8. Allow the safety belt to retract to remove any slack in the belt.

9. Before placing the child in the seat, forcibly tilt the seat forward and back to make sure the seat is securely held in place.

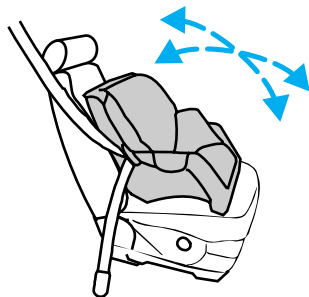

Seating and safety restraints

10. Try to pull the belt out of the retractor to make sure the retractor is in the automatic locking mode (you should not be able to pull more belt out). If the retractor is not locked, unbuckle the belt and repeat steps two through nine.

Check to make sure the child seat is properly secured before each use.

Attaching safety seats with tether straps

Some manufacturers make safety seats that include a tether strap that goes over the back of the vehicle seat and attaches to an anchoring point. Other manufacturers offer the tether strap as an accessory. Contact the manufacturer of your child safety seat for information about ordering a tether strap.

Tether anchorage hardware

A tethered seat can be installed in the front seat. Put the tether strap over the seatback and attach it to a anchor bracket.

An anchor bracket can be installed on the rear edge of the front seat cushion.

The provision (attaching hole) is provided in the rear edge of the front passenger seat cushion frame. The anchorbracket must be installed using the instructions provided with the kit.

Tether anchorage hardware kits (part number 613D74) including instructions, may be obtained at no charge from any Ford or Lincoln-Mercury dealer.



Tighten the anchor according to specifications. Otherwise, the safety seat may not be properly secured and the child may be injured in a sudden stop or collision.

BUILT-IN CHILD SEATS

Built-in child safety seat (if equipped)

The rear seat may include a built-in child seat. This child seat conforms to all Federal and local motor vehicle safety standard. Read the labels located on the child seat cushion and shoulder belt for information on the built-in child seat.

Seating and safety restraints

Use the built-in child seat **only** if the child is at least 9 months old, weighs 9–29 kg (20–60 lb) and the child's shoulders (top) are below the shoulder harness slots in the built-in child seat.

Children not meeting these requirements should be secured in an approved aftermarket seat. Refer to *Children and infant or child safety seats* in this chapter.

Placing your child in the built-in child seat



Failure to follow all of the instructions on the use of this child restraint system can result in your child striking the vehicle's interior during a sudden stop or crash.



The second row seatback must be fully locked before operating the child restraint system. Check the position of the seatback release lever.



Never use the Built-In Child Seat as a booster cushion with the adult safety belts. A child using the adult belts could slide forward and out from under the safety belts.

1. Grasp the strap and pull toward you approximately 25 mm (1 inch), then slide hand under the head restraint and slide upwards to the full position.



Seating and safety restraints

2. Pull both Velcro® straps to release the child seat cushion.

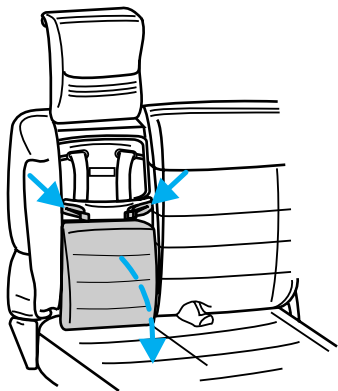

3. Lower the child seat cushion.

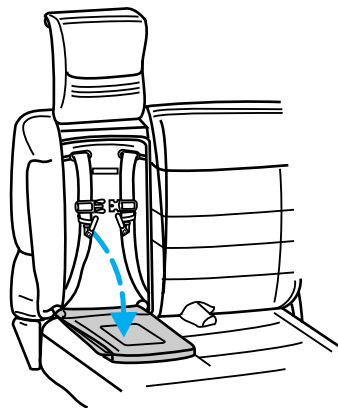

Seating and safety restraints

4. Unfold the cushion protector flap onto adult seat cushion

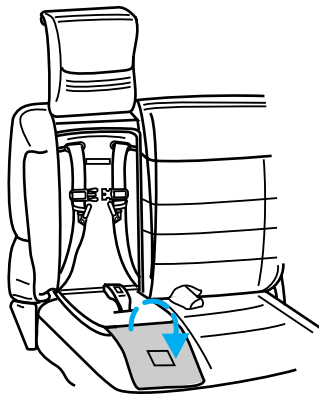

5. If connected, disconnect the chest clip and buckles.

6. Place the child in the seat and position the left shoulder belt over the child's left shoulder first, then place the right shoulder belt over the child's right shoulder.



Seating and safety restraints

7. Insert the left and right safety belt tongues into the left and right slots of the crotch buckle. Verify that the indicator window on each tongue is green to ensure proper safety belt connections.

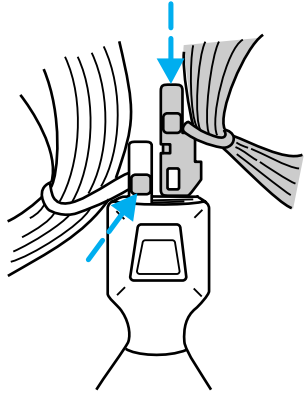

If both tongues do not latch in the buckle, do not use the child seat. See your dealer for repairs.

8. Fasten the right and left chest clip halves together and adjust the clip to comfortably hold the shoulder belts in place over the child's chest.

The chest clip is designed to easily pull apart in a collision. The clip helps to keep belts snug on a sleeping or squirming child.

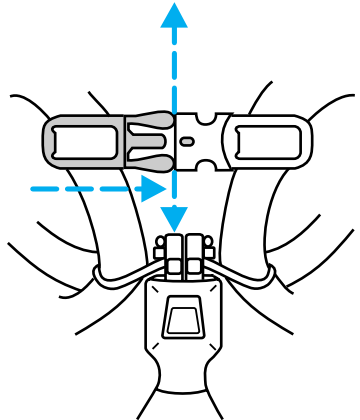

Seating and safety restraints

9. Pull on the safety belt tongues to ensure that they are both securely latched. If they are not properly latched, repeat steps seven and eight.

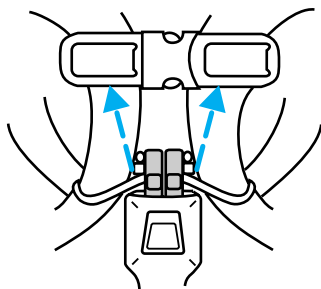

If necessary, the shoulder belt may be put in automatic locking mode (ALR) to limit the child's movement in the seat. The ALR mode should be used if the child is sleeping or attempting to get out of the seat.

If not placed in ALR mode, the child seat shoulder belts are in vehicle sensitive (emergency locking) mode, which allow some movement of the shoulder belts (like adult shoulder belts).

In emergency locking mode, the shoulder belts of the child seat will lock in response to hard braking, hard cornering or if your vehicle is involved in a collision with an impact of 8 km/h (5 m.p.h.) or more.

Activating the automatic locking mode (ALR) on the built-in child safety seat

1. Fully extend the right shoulder belt.
2. Allow the belts to tighten snugly against the child's shoulders.

Deactivating the automatic locking mode (ALR) on the built-in child safety seat

1. Disconnect the chest clip and remove the left and right safety belt tongues from the crotch buckle.
2. Allow the shoulder belts to fully retract.

Seating and safety restraints

Removing your child from the built-in child safety seat

1. Disconnect the chest clip by squeezing the release tabs together and pulling the two sides apart.
2. Press the release button on the crotch buckle.
3. Slide the shoulder belts off the child's shoulders and remove the child from the seat.

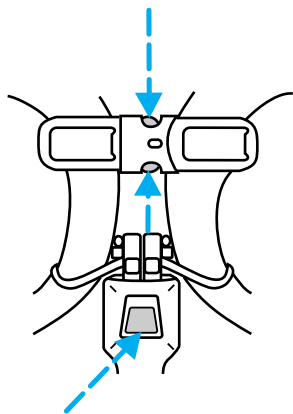

If ALR is activated, hold either the left or right shoulder belt out fully while helping the child slide arms out of the belts.

4. Fold the cushion protector flap onto the child seat cushion. Slide the belt tongues up and out of the way of the cushion, then return the child seat cushion to the stowed (upright) position.
5. Slide the Velcro® straps through the D-rings on the child seat cushion and attach.
6. Slide the head restraint down until the top of the head restraint is flush with the top of the adult seat back.

Seating and safety restraints

7. Press firmly on the top center of the built-in child safety seat head restraint to ensure it is stowed properly.

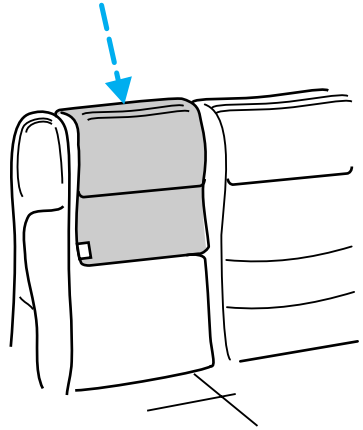

Inspecting the built-in child seat after a collision

Inspect all built-in child restraints, including seats, buckles, retractors, seat latches. Interlocks and attaching hardware should be inspected by a qualified technician after any collision. If the child seat was in use during a collision, Ford recommends replacing it. Built-in child restraints not in use during a collision should be inspected and replaced if either damage or improper operation is noted.

PREPARING TO START YOUR VEHICLE

Engine starting is controlled by the ignition system. This system meets all Canadian Interference-Causing Equipment standard requirements regulating the impulse electrical field strength of radio noise.

When starting a fuel-injected engine, avoid pressing the accelerator before or during starting. Only use the accelerator when you have difficulty starting the engine. For more information on starting the vehicle, refer to *Starting the engine* in this chapter.



Extended idling at high engine speeds can produce very high temperatures in the engine and exhaust system, creating the risk of fire or other damage.



Do not park, idle, or drive your vehicle in dry grass or other dry ground cover. The emission system heats up the engine compartment and exhaust system, which can start a fire.



Do not start your vehicle in a closed garage or in other enclosed areas. Exhaust fumes can be toxic. Always open the garage door before you start the engine. See *Guarding against exhaust fumes* in this chapter for more instructions.



If you smell exhaust fumes inside your vehicle, have your dealer inspect your vehicle immediately. Do not drive if you smell exhaust fumes.

Important safety precautions

A computer system controls the engine's idle revolutions per minute (RPM). When the engine starts, the idle RPM runs faster to warm the engine. If the engine idle speed does not slow down automatically, have the vehicle checked.

Before starting the vehicle:

1. Make sure all vehicle occupants have buckled their safety belts. For more information on safety belts and their proper usage, refer to the *Seating and safety restraints* chapter.
2. Make sure the headlamps and vehicle accessories are off.

Starting

If starting a vehicle with an automatic transmission:

- Make sure the parking brake is set.

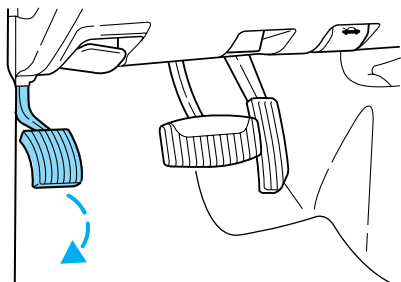

- Make sure the gearshift is in P (Park).

If starting a vehicle with a manual transmission:

- Make sure the parking brake is set.
- Push the clutch pedal to the floor.

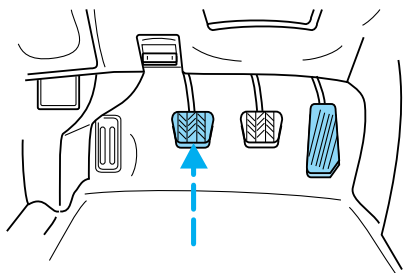

3. Turn the key to 4 (ON) without turning the key to 5 (START).

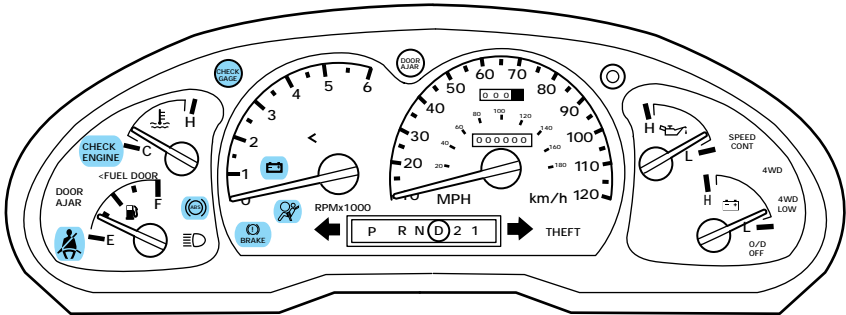
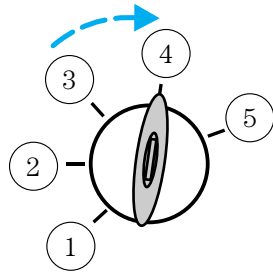

Make sure the corresponding lights illuminate briefly. If a light fails to illuminate, have the vehicle serviced.

- If the driver's safety belt is fastened, the light () will not illuminate.

Starting

STARTING THE ENGINE

1. Turn the key to 5 (START) without pressing the accelerator pedal and release as soon as the engine starts. The key will return to 4 (ON).

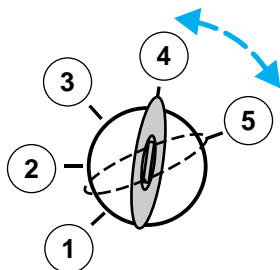

2. If the engine does not start within five seconds, wait ten seconds and try again.

3. If the engine does not start in two attempts or if the temperature is below -12°C (10°F), depress the accelerator and start the engine while holding the accelerator down. Release the accelerator when the engine starts.

4. After idling for a few seconds, apply the brake and release the parking brake.

Using the engine block heater (if equipped)

An engine block heater warms the engine coolant, which improves starting, warms up the engine faster and allows the heater-defroster system to respond quickly. They are strongly recommended if you live in a region where temperatures reach -23°C (-10°F) or below.

For best results, plug the heater in at least three hours before starting the vehicle. Using the heater for longer than three hours will not harm the engine, so the heater can be plugged in the night before starting the vehicle.



To prevent electrical shock, do not use your heater with ungrounded electrical systems or two-pronged (cheater) adapters.

Guarding against exhaust fumes

Although odorless and colorless, carbon monoxide is present in exhaust fumes. Take precautions to avoid its dangerous effects.



If you ever smell exhaust fumes of any kind inside your vehicle, have your dealer inspect and fix your vehicle immediately. Do not drive if you smell exhaust fumes. These fumes are harmful and could kill you.

Have the exhaust and body ventilation systems checked whenever:

- the vehicle is raised for service.
- the sound of the exhaust system changes.
- the vehicle has been damaged in a collision.

Important ventilating information

If the engine is idling while the vehicle is stopped in an open area for long periods of time, open the windows at least 2.5 cm (one inch).

Adjust the heating or air conditioning (if equipped) to bring in fresh air.

Improve vehicle ventilation by keeping all air inlet vents clear of snow, leaves and other debris.

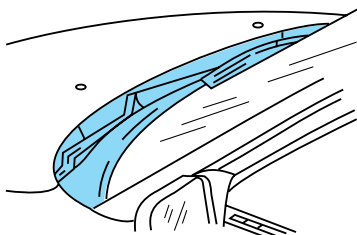

Driving

BRAKES

Your brakes are self-adjusting. Refer to the “Service Guide” for scheduled maintenance.

Occasional brake noise is normal and often does not indicate a performance concern with the vehicle’s brake system. In normal operation, automotive brake systems may emit occasional or intermittent squeal or groan noises when the brakes are applied. Such noises are usually heard during the first few brake applications in the morning; however, they may be heard at any time while braking and can be aggravated by environmental conditions such as cold, heat, moisture, road dust, salt or mud. If a “metal-to-metal”, “continuous grinding” or “continuous squeal” sound is present while braking, the brake linings may be worn-out and should be inspected by a qualified service technician.

Anti-lock brake system (ABS)

On vehicles equipped with an anti-lock braking system (ABS), a noise from the hydraulic pump motor and pulsation in the pedal may be observed during ABS braking events. Pedal pulsation coupled with noise while braking under panic conditions or on loose gravel, bumps, wet or snowy roads is normal and indicates proper functioning of the vehicle’s anti-lock brake system. If the vehicle has continuous vibration or shudder while braking, felt mainly in the steering wheel, the vehicle most likely needs service.

The ABS operates by detecting the onset of wheel lock up during brake applications and compensating for this tendency. The front wheels are prevented from locking even when the brakes are firmly applied. The accompanying illustration depicts the advantage of an ABS equipped vehicle (on bottom) to a non-ABS equipped vehicle (on top) during hard braking.

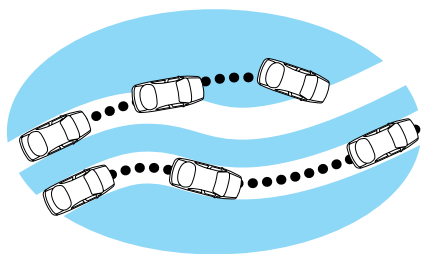

ABS warning lamp

The  warning lamp in the instrument cluster illuminates for about five seconds when starting the vehicle. If an ABS fault is detected, the

light will remain on and your vehicle should be serviced as soon as possible.

Normal braking is still effective unless the BRAKE warning lamp is also illuminated.



Using ABS

- In an emergency or when maximum efficiency from the ABS is required, apply continuous full force on the brake. The ABS will be activated immediately, thus allowing you to retain full steering control of your vehicle and, providing there is sufficient space, will enable you to avoid obstacles and bring the vehicle to a controlled stop.
- We recommend that you familiarize yourself with this braking technique. However, avoid taking any unnecessary risks.

Parking brake

Apply the parking brake whenever the vehicle is parked. To set the parking brake, press the parking brake pedal down until the pedal stops.

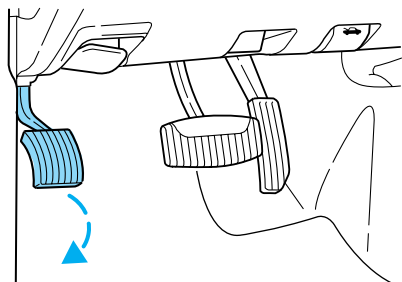

The BRAKE warning lamp in the instrument cluster illuminates and remains illuminated (when the ignition is turned ON) until the parking brake is released.



Driving



Always set the parking brake fully and make sure that the gearshift is securely latched in P (Park) (automatic transmission) or in 1 (First) (manual transmission).

The parking brake is not designed to stop a moving vehicle. However, if the normal brakes fail, the parking brake can be used to stop your vehicle in an emergency. Since the parking brake applies only the rear brakes, the vehicle's stopping distance will be adversely affected.

Pull the release lever to release the brake. Driving with the parking brake on will cause the brakes to wear out quickly and reduce fuel economy.

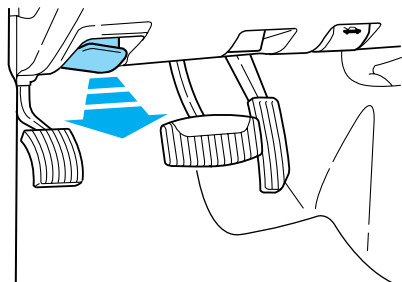

AIR SUSPENSION SYSTEM (IF EQUIPPED)

The air suspension system is designed to improve ride, handling and general vehicle performance during:

- certain road conditions
- steering maneuvers
- braking
- accelerations

This system maintains the vehicle height at a constant level by automatically adding air or releasing air from the springs to offset changes in vehicle loads.

The air suspension shut-off switch is located in the cargo area behind the left rear quarter trim panel.

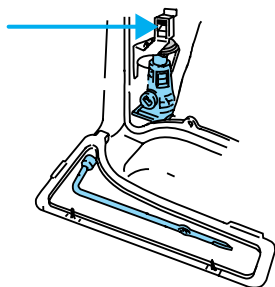

 On vehicles equipped with Air Suspension, turn OFF the Air Suspension switch prior to jacking, hoisting or towing your vehicle.

Normal vehicle operation does not require any action by the driver.

TRANSMISSION OPERATION

Automatic transmission operation

Brake-shift interlock

This vehicle is equipped with a brake-shift interlock feature that prevents the gearshift from being moved from P (Park) unless the brake pedal is depressed.

If you cannot move the gearshift out of P (Park) with the brake pedal depressed:

1. Apply the parking brake, turn ignition key to LOCK, then remove the key.
2. Insert the key and turn it to OFF. Apply the brake pedal and shift to N (Neutral).
3. Start the vehicle.

If it is necessary to use the above procedure to move the gearshift, it is possible that a fuse has blown. Refer to *Fuses and relays* in the *Roadside emergencies* chapter.

 Do not drive your vehicle until you verify that the brakelamps are working.

If your vehicle gets stuck in mud or snow it may be rocked out by shifting from forward and reverse gears in a steady pattern. Press lightly on the accelerator in each gear.

Driving

Do not rock the vehicle for more than a few minutes. The transmission and tires may be damaged or the engine may overheat.



Always set the parking brake fully and make sure the gearshift is latched in P (Park). Turn off the ignition whenever you leave your vehicle.

Driving with a 4-speed automatic transmission (5.0L engines only)

Understanding gearshift positions

Pull the gearshift lever towards you and downward to move the automatic gearshift.



Hold the brake pedal down while you move the gearshift lever from position to position. If you do not hold the brake pedal down, your vehicle may move unexpectedly and injure someone.

P (Park)

Always come to a complete stop before shifting into P (Park). Make sure the gearshift is securely latched in P (Park).



R (Reverse)

With the gearshift in R (Reverse), the vehicle will move backward. Always come to a complete stop before shifting into and out of R (Reverse).



N (Neutral)

With the gearshift in N (Neutral), the vehicle can be started and is free to roll. Hold the brake pedal down while in this gear.

**D (Overdrive)**

The normal driving position for the best fuel economy. Transmission operates in gears one through four.



D (Overdrive) can be deactivated by pressing the transmission control switch on the end of the gearshift lever.

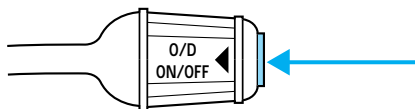

The transmission control indicator light (TCIL) will illuminate on the instrument cluster.

O/D
OFF

Drive – Not shown on the display. Activate by pressing the transmission control switch on the end of the gearshift lever with the gearshift in the **D** position. The TCIL will illuminate on the instrument cluster. Transmission operates in gears one through three. **D** (Drive) provides more engine braking than **D** (Overdrive) and is useful when:

- driving with a heavy load
- towing a trailer up or down steep hills
- additional engine braking is desired. If towing a trailer, refer to *Driving while you tow* in the *Towing a trailer* chapter.

Driving

To return to **D** (Overdrive) mode, press the transmission control switch. The TCIL will no longer be illuminated.

Each time the vehicle is started, the transmission will automatically return to normal overdrive mode.

Every time the vehicle is shut off and restarted, you must press the transmission control switch to cancel overdrive operation if driving in overdrive is not desired.

2 (Second)

Use 2 (Second) to start-up on slippery roads or to provide additional engine braking on downgrades.



1 (First)

Use 1 (Low) to provide maximum engine braking on steep downgrades. Upshifts can be made by shifting to 2 (Second) or to **D** (Overdrive). Selecting 1 (Low) at higher speeds causes the transmission to shift to a lower gear, and will shift to 1 (Low) after vehicle decelerates to the proper speed.



Driving with a 5-speed automatic transmission (4.0L engines only)

Understanding gearshift positions



Hold the brake pedal down while you move the gearshift lever from position to position. If you do not hold the brake pedal down, your vehicle may move unexpectedly and injure someone.

Pull the gearshift lever towards you and downward to move the automatic gearshift.

P (Park)

Always come to a complete stop before shifting into or out of P (Park). Make sure the gearshift is securely latched in P (Park).



R (Reverse)

With the gearshift in R (Reverse), the vehicle will move backward. Always come to a complete stop before shifting into and out of R (Reverse).



N (Neutral)

With the gearshift in N (Neutral), the vehicle can be started and is free to roll. Hold the brake pedal down while in this gear.



D (Overdrive)

The normal driving position for the best fuel economy. Transmission operates in gears one through five.



D (Overdrive) can be deactivated by pressing the transmission control switch on the end of the gearshift lever.

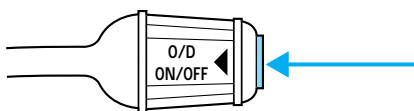

Driving

The transmission control indicator light (TCIL) will illuminate on the instrument cluster.

O/D
OFF

Drive – Not shown on the display. Activate by pressing the transmission control switch on the end of the gearshift lever with the gearshift in the **D** position. The TCIL will illuminate on the instrument cluster. Transmission operates in gears one through four. **D** (Drive) provides more engine braking than **D** (Overdrive) and is useful whenever driving conditions (i.e., city traffic, hilly terrain, etc.) cause the transmission to excessively shift between **D** (Overdrive) and **D** (Drive). Also deactivate **D** (Overdrive) when:

- driving with a heavy load
- towing a trailer up or down steep hills
- additional engine braking is desired.

To return to **D** (Overdrive) mode, press the transmission control switch. The TCIL will no longer be illuminated.

Each time the vehicle is started, the transmission will automatically return to normal overdrive mode.

2 (Second)

Use 2 (Second) to start-up on slippery roads or to provide additional engine braking on downgrades. Transmission operates in third gear.



1 (First)

Use 1 (First) to provide maximum engine braking on steep downgrades. Upshifts can be made by shifting to 2 (Second) or to **D** (Overdrive). Selecting 1 (Low) at higher speeds causes the transmission to shift to a lower gear



and will shift to 1 (First) after the vehicle decelerates to the proper vehicle speed.

Driving a manual transmission (if equipped)

Using the clutch

Vehicles equipped with a manual transmission have a starter interlock that prevents cranking the engine unless the clutch pedal is fully depressed.

When starting a vehicle with a manual transmission:

1. Hold down the brake pedal.
2. Put the gearshift lever in N (Neutral).
3. Depress the clutch pedal.
4. Crank the engine and let it idle for a few seconds.
 - Put the gearshift in 1 (First) or R (Reverse).
5. Release the clutch slowly while pressing gradually down on the accelerator pedal.
 - Do not drive with your foot resting on the clutch pedal. Do not use the clutch to hold your vehicle at a standstill while waiting on a hill. These actions may reduce clutch life.

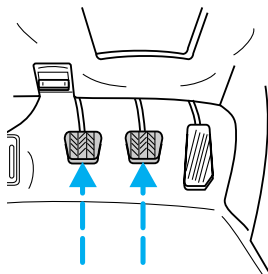

Driving

Recommended shift speeds

Upshifts when accelerating (for best fuel economy)		
Shift from:	Transfer case position (if equipped)	
	AUTO or HIGH	LOW
1 - 2	14 km/h (10 mph)	5 km/h (4 mph)
2 - 3	32 km/h (22 mph)	11 km/h (9 mph)
3 - 4	50 km/h (33 mph)	19 km/h (13 mph)
4 - 5 (Overdrive)	71 km/h (41 mph)	27 km/h (17 mph)
Upshifts when cruising (recommended for best fuel economy)		
Shift from:	Transfer case position (if equipped)	
	AUTO or HIGH	LOW
1 - 2	16 km/h (10 mph)	6 km/h (4 mph)
2 - 3	26 km/h (19 mph)	10 km/h (8 mph)
3 - 4	43 km/h (28 mph)	16 km/h (12 mph)
4 - 5 (Overdrive)	68 km/h (40 mph)	26 km/h (16 mph)
Maximum downshift speeds		
Shift from:	Transfer case position (if equipped)	
	AUTO or HIGH	LOW
5 (Overdrive) - 4	88 km/h (55 mph)	34 km/h (22 mph)
4 - 3	72 km/h (45 mph)	34 km/h (18 mph)
3 - 2	56 km/h (35 mph)	21 km/h (14 mph)
2 - 1	32 km/h (20 mph)	11 km/h (8 mph)

Parking

1. Apply the brake and shift into N (Neutral).

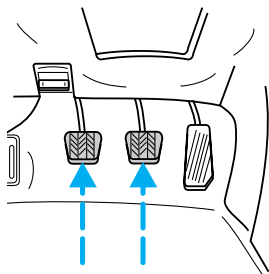

2. Engage the parking brake.

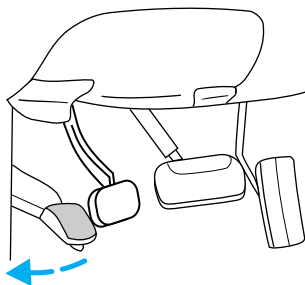

3. Shift into 1 (First).

4. Turn the ignition to Off.



Do not park your vehicle in Neutral, it may move unexpectedly and injure someone. Use 1 (First) gear and set the parking brake fully.

Reverse

Ensure that the vehicle is at a complete stop before shifting into R (Reverse). Failure to do so may damage the transmission.

Put the gearshift into N and wait at least several seconds before shifting into R.

Driving

You can shift into R (Reverse) only by moving the gearshift from left of 3 (Third) and 4 (Fourth) gears before you shift into R (Reverse). This is a special lockout feature that protects you from accidentally shifting into R (Reverse) when you downshift from 5 (Overdrive).

CONTROL-TRAC AUTOMATIC FOUR-WHEEL DRIVE SYSTEM (IF EQUIPPED)

The 4WD system uses all four wheels to power the vehicle. This increases traction, enabling you to drive your 4x4 over terrain and road conditions not normally traveled by two-wheel drive vehicles.

Power is supplied to all four wheels through a transfer case that allows you to select a four-wheel drive mode best suited for your current driving conditions.

Positions of the Control-Trac system

The Control-Trac system functions in three modes:

- The 4WD AUTO mode provides four-wheel drive with full power delivered to the rear axle, and to the front axle as required for increased traction. This is appropriate for normal on-road operating conditions, such as dry road surfaces, wet pavement, snow and gravel.

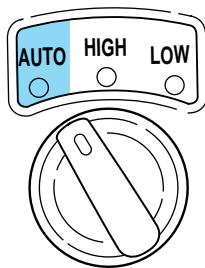

- The 4WD HIGH mode provides four-wheel drive with full power to both axles. It is only intended for severe winter or off-road conditions, such as deep snow and ice (where no dry or wet pavement remains uncovered), and shallow sand.

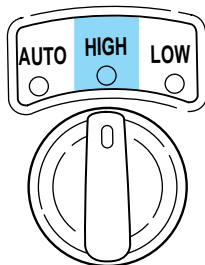

- The 4WD LOW mode supplies four-wheel drive with full power to both axles and includes a lower gear ratio for low-speed. It is only intended for off-road applications that require extra power including deep sand, steep grades and pulling a boat and trailer out of the water.

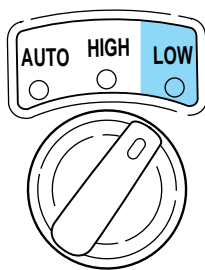

The vehicle should not be operated in 4WD HIGH and 4WD LOW on dry or merely wet pavement. Doing so will produce excessive noise, increase tire wear and may damage driveline components. These modes are intended for use only on consistently slippery or loose surfaces.

If your vehicle is equipped with 4WD or AWD, a spare tire of a different size than the road tires should never be used. Such a tire could result in damage to driveline components and make the vehicle difficult to control.



Utility and four-wheel drive vehicles are **not** designed for cornering at speeds as high as passenger cars any more than low-slung sports cars are designed to perform satisfactorily under off-road conditions. Avoid sharp turns or abrupt maneuvers in these vehicles.

Driving

Using the Control-Trac system

Shifting between 4WD AUTO and 4WD HIGH

When you move the control to 4WD HIGH, the indicator light will illuminate in the instrument cluster. When you move the control to 4WD AUTO, the indicator light will turn off.

Either shift can be done at a stop or while driving at any speed.

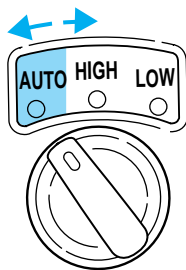

Shifting from 4WD AUTO or 4WD HIGH to 4WD LOW

1. Bring the vehicle to a stop.
2. Depress the brake.
3. Place the gearshift in N (Neutral) (automatic transmission) or depress the clutch (manual transmission).
4. Move the 4WD control to the 4WD LOW position.

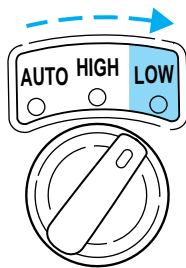

Shifting from 4WD LOW to 4WD AUTO or 4WD HIGH

1. Bring the vehicle to a stop.
2. Depress the brake.
3. Place the gearshift in N (Neutral) (automatic transmission) or depress the clutch (manual transmission).
4. Move the 4WD control to the 4WD AUTO or 4WD HIGH position.

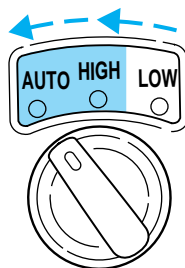

Driving off-road with 4WD

Your vehicle is specially equipped for driving on sand, snow, mud and rough terrain and has operating characteristics that are somewhat different from conventional vehicles, both on and off the road.

Maintain steering wheel control at all times, especially in rough terrain. Since sudden changes in terrain can result in abrupt steering wheel motion, make sure you grip the steering wheel from the outside. Do not grip the spokes.

Drive cautiously to avoid vehicle damage from concealed objects such as rocks and stumps.

You should either know the terrain or examine maps of the area before driving. Map out your route before driving in the area. For more information on driving off-road, read the “Four Wheeling” supplement in your owner’s portfolio.

If your vehicle gets stuck

If the vehicle is stuck, shift the transmission in a steady motion between forward and reverse gears. Allow the transmission to engage, then press lightly on the accelerator.

Do not rock the vehicle for more than a few minutes. The transmission and tires may be damaged or the engine can overheat.

Driving



Do not spin the wheels at over 56 km/h (35 mph). The tires may fail and injure a passenger or bystander.

Sand

When driving over sand, try to keep all four wheels on the most solid area of the trail. Do not reduce the tire pressures but shift to a lower gear and drive steadily through the terrain. Apply the accelerator slowly and avoid spinning the wheels.

Mud and water

If you must drive through high water, drive slowly. Traction or brake capability may be limited.

When driving through water, determine the depth; avoid water higher than the bottom of the hubs (if possible) and proceed slowly. If the ignition system gets wet, the vehicle may stall.

Once through water, always try the brakes. Wet brakes do not stop the vehicle as effectively as dry brakes. Drying can be improved by moving your vehicle slowly while applying light pressure on the brake pedal.

After driving through mud, clean off residue stuck to rotating driveshafts and tires. Excess mud stuck on tires and rotating driveshafts causes an imbalance that could damage drive components.

If the transmission and transfer case are submerged in water, their fluids should be checked and changed, if necessary.

Water intrusion into the transmission may damage the transmission.

If the rear axle is submerged in water, the rear axle lubricant should be checked and changed, if necessary. The rear axle is filled with a synthetic lubricant and does not normally require a lubricant change for the life of the vehicle. Rear axle lubricant quantities should not need to be checked unless a leak is suspected.

Driving on hilly or sloping terrain

When driving on a hill, avoid driving crosswise or turning on steep slopes. You could lose traction and slip sideways. Drive straight up, straight down or avoid the hill completely. Know the conditions on the other side of a hill before driving over the crest.

When climbing a steep hill, start in a lower gear rather than downshifting to a lower gear from a higher gear once the ascent has started. This

reduces strain on the engine and the possibility of stalling.

When descending a steep hill, avoid sudden braking. Rapid pumping of the brake pedal will help slow the vehicle and still maintain steering control.

When speed control is on and you are driving uphill, your vehicle speed may drop considerably, especially if you are carrying a heavy load.

If vehicle speed drops more than 16 km/h (10 mph), the speed control will cancel automatically. Resume speed with accelerator pedal.

If speed control cancels after climbing the hill, reset speed by pressing and holding the SET ACCEL button (to resume speeds over 50 km/h (30 mph)).

Automatic transmissions may shift frequently while driving up steep grades. Eliminate frequent shifting by shifting out of **D** (Overdrive) into D (Drive).

Driving on snow and ice

A 4WD vehicle has advantages over 2WD vehicles in snow and ice but can skid like any other vehicle.

Avoid sudden applications of power and quick changes of direction on snow and ice. Apply the accelerator slowly and steadily when starting from a full stop.

When braking, apply the brakes as you normally would. In order to allow the anti-lock brake system (ABS) to operate properly, keep steady pressure on the brake pedal.

Allow more stopping distance and drive slower than usual. Consider using one of the lower gears.

ALL WHEEL DRIVE (AWD) SYSTEM (IF EQUIPPED) (5.0L ENGINES ONLY)

Your vehicle is equipped with a full-time All Wheel Drive (AWD) transfer case. Power is supplied to all four wheels all the time with no need to shift between two-wheel drive and four-wheel drive.

For the lubricant specification and refill capacity of the AWD transfer case refer to *Capacities and specifications* chapter.

Driving



Utility and four-wheel drive vehicles are **not** designed for cornering at speeds as high as passenger cars any more than low-slung sports cars are designed to perform satisfactorily under off-road conditions. Avoid sharp turns or abrupt maneuvers in these vehicles.

Driving off-road with AWD

Your vehicle is specially equipped for driving on sand, snow, mud and rough terrain and has operating characteristics that are somewhat different from conventional vehicles, both on and off the road.

Maintain steering wheel control at all times, especially in rough terrain. Since sudden changes in terrain can result in abrupt steering wheel motion, make sure you grip the steering wheel from the outside. Do not grip the spokes.

Drive cautiously to avoid vehicle damage from concealed objects such as rocks and stumps.

You should either know the terrain or examine maps of the area before driving. Map out your route before driving in the area. For more information on driving off-road, read the “Four Wheeling” supplement in your owner’s portfolio.

If your vehicle gets stuck

If the vehicle is stuck, shift the transmission in a steady motion between forward and reverse gears. Allow the transmission to engage, then press lightly on the accelerator.

Do not rock the vehicle for more than a few minutes. The transmission and tires may be damaged or the engine can overheat.



Do not spin the wheels at over 56 km/h (35 mph). The tires may fail and injure a passenger or bystander.

Sand

When driving over sand, try to keep all four wheels on the most solid area of the trail. Do not reduce the tire pressures but shift to a lower gear and drive steadily through the terrain. Apply the accelerator slowly and avoid spinning the wheels.

Mud and water

If you must drive through high water, drive slowly. Traction or brake capability may be limited.

When driving through water, determine the depth; avoid water higher than the bottom of the hubs (if possible) and proceed slowly. If the ignition system gets wet, the vehicle may stall.

Once through water, always try the brakes. Wet brakes do not stop the vehicle as effectively as dry brakes. Drying can be improved by moving your vehicle slowly while applying light pressure on the brake pedal.

After driving through mud, clean off residue stuck to rotating driveshafts and tires. Excess mud stuck on tires and rotating driveshafts causes an imbalance that could damage drive components.

If the transmission and transfer case are submerged in water, their fluids should be checked and changed, if necessary.

Water intrusion into the transmission may damage the transmission.

If the rear axle is submerged in water, the rear axle lubricant should be checked and changed, if necessary. The rear axle is filled with a synthetic lubricant and does not normally require a lubricant change for the life of the vehicle. Rear axle lubricant quantities should not need to be checked unless a leak is suspected.

Driving on hilly or sloping terrain

When driving on a hill, avoid driving crosswise or turning on steep slopes. You could lose traction and slip sideways. Drive straight up, straight down or avoid the hill completely. Know the conditions on the other side of a hill before driving over the crest.

When climbing a steep hill, start in a lower gear rather than downshifting to a lower gear from a higher gear once the ascent has started. This reduces strain on the engine and the possibility of stalling.

When descending a steep hill, avoid sudden braking. Rapid pumping of the brake pedal will help slow the vehicle and still maintain steering control.

When speed control is on and you are driving uphill, your vehicle speed may drop considerably, especially if you are carrying a heavy load.

If vehicle speed drops more than 16 km/h (10 mph), the speed control will cancel automatically. Resume speed with accelerator pedal.

Driving

If speed control cancels after climbing the hill, reset speed by pressing and holding the SET ACCEL button (to resume speeds over 50 km/h (30 mph)).

Automatic transmissions may shift frequently while driving up steep grades. Eliminate frequent shifting by shifting out of **D** (Overdrive) into D (Drive).

Driving on snow and ice

An AWD vehicle has advantages over 2WD vehicles in snow and ice but can skid like any other vehicle.

Avoid sudden applications of power and quick changes of direction on snow and ice. Apply the accelerator slowly and steadily when starting from a full stop.

When braking, apply the brakes as you normally would. In order to allow the anti-lock brake system (ABS) to operate properly, keep steady pressure on the brake pedal.

Allow more stopping distance and drive slower than usual. Consider using one of the lower gears.

TRACTION-LOK AXLE (IF EQUIPPED)

This axle provides added traction on slippery surfaces, particularly when one wheel is on a poor traction surface. Under normal conditions, the Traction-Lok axle functions like a standard rear axle.

Extended use of other than the manufacturer's specified size tires on a Traction-Lok rear axle could result in a permanent reduction in effectiveness. This loss of effectiveness does not affect normal driving and should not be noticeable to the driver.



To avoid injury, never run the engine with one wheel off the ground, such as when changing a tire.

VEHICLE LOADING

Before loading a vehicle, familiarize yourself with the following terms:

- **Base Curb Weight** : Weight of the vehicle including any standard equipment, fluids, lubricants, etc. It does not include passengers or aftermarket equipment.

- **Payload** : Combined maximum allowable weight of cargo, passengers and optional equipment. The payload equals the gross vehicle weight rating minus base curb weight.
- **GVW (Gross Vehicle Weight)** : Base curb weight plus payload weight. The GVW is not a limit or a specification.
- **GVWR (Gross Vehicle Weight Rating)** : Maximum total weight of the base vehicle, passengers, optional equipment and cargo. The GVWR is specific to each vehicle and is listed on the Safety Compliance Label on the driver's door pillar.
- **GAWR (Gross Axle Weight Rating)** : Carrying capacity for each axle system. The GAWR is specific to each vehicle and is listed on the Safety Compliance Label on the driver's door pillar.
- **GCWR (Gross Combined Weight Rating)** : Maximum combined weight of towing vehicle (including passengers and cargo) and the trailer. The GCWR indicates the maximum loaded weight that the vehicle is allowed to tow.
- **Maximum Trailer Weight Rating** : Maximum weight of a trailer the vehicle is permitted to tow. The maximum trailer weight rating equals the vehicle curb weight for each engine/transmission combination, any required option weight for trailer towing and the weight of the driver from the GCWR for the towing vehicle.
- **Maximum Trailer Weight** : maximum weight of a trailer the loaded vehicle (including passengers and cargo) is permitted to tow. It is determined by subtracting the weight of the loaded trailer towing vehicle from the GCWR for the towing vehicle.
- **Trailer Weight Range** : Specified weight range that the trailer must fall within that ranges from zero to the maximum trailer weight rating.

Remember to figure in the tongue load of your loaded trailer when figuring the total weight.



Do not exceed the GVWR or the GAWR specified on the Safety Compliance Certification Label.

Do not use replacement tires with lower weight capacities than the originals because they may lower the vehicle's GVWR and GAWR limitations. Replacement tires with a higher weight limit than the originals do not increase the GVWR and GAWR limitations.

Driving

Calculating the load your vehicle can carry/tow

1. Use the Safety Compliance Certification Label to find the axle code number and engine type for your vehicle.
2. Use the appropriate maximum gross combined weight rating (GCWR) chart to find the maximum GCWR for your type engine and rear axle ratio.
3. Weigh your vehicle as you customarily operate the vehicle without cargo. To obtain correct weights, try taking your vehicle to a shipping company or an inspection station for trucks.
4. Subtract your loaded vehicle weight from the maximum GCWR on the following charts. This is the maximum trailer weight your vehicle can tow and must fall below the maximum shown under maximum trailer weight on the chart.

DRIVING THROUGH WATER

Do not drive quickly through standing water, especially if the depth is unknown. Traction or brake capability may be limited and if the ignition system gets wet, your engine may stall. Water may also enter your engine's air intake and severely damage your engine.

If driving through deep or standing water is unavoidable, proceed very slowly. Never drive through water that is higher than the bottom of the hubs (truck)/wheel rims (car).

Once through the water, always try the brakes. Wet brakes do not stop the vehicle as effectively as dry brakes. Drying can be improved by moving your vehicle slowly while applying light pressure on the brake pedal.

TRAILER TOWING

Trailer towing with your vehicle may require the use of a trailer tow option package.

Trailer towing puts additional loads on your vehicle's engine, transmission, axle, brakes, tires, and suspension. For your safety and to maximize vehicle performance, be sure to use the proper equipment while towing.

Follow these guidelines to ensure safe towing procedure:

- Stay within your vehicle's load limits.

- Thoroughly prepare your vehicle for towing. Refer to *Preparing to tow* in this chapter.
- Use extra caution when driving while trailer towing. Refer to *Driving while you tow* in this chapter.
- Service your vehicle more frequently if you tow a trailer. Refer to the severe duty schedule in the “Service Guide”.
- Do not tow a trailer until your vehicle has been driven at least 800 km (500 miles).
- Refer to the instructions included with towing accessories for the proper installation and adjustment specifications.

Do not exceed the maximum loads listed on the Safety Compliance Certification label. For load specification terms found on the label, refer to *Vehicle loading* in this chapter. Remember to figure in the tongue load of your loaded vehicle when figuring the total weight.

Trailer towing table (4x2 manual transmission)				
GCWR (Gross Combined Weight Rating)/Trailer weights				
Engine	Rear axle ratio	Maximum GCWR-kg (lbs.)	Trailer weight range-kg (lbs.) (0-Maximum)	Maximum frontal area of trailer-m² (ft²)
2-door				
4.0L EFI	3.27	2 721 (6 000)	0-907 (0-2 000)	4.64 (50)
4.0L EFI	3.73	3 175 (7 000)	0-1 424 (0-3 140)	4.64 (50)
4-door				
4.0L EFI	3.27	2 721 (6 000)	0-880 (0-1 940)	4.64 (50)
4.0L EFI	3.73	3 175 (7 000)	0-1 325 (0-2 920)	4.64 (50)
<p>Notes: -For high altitude operation, reduce GCW by 2% per 300 meters (1 800 ft) elevation. For definitions of terms used in this table and instructions on how to calculate your vehicle load, refer to <i>Vehicle loading</i> in this chapter. Maximum trailer weights shown. The combined weight of the completed towing vehicle and the loaded trailer must not exceed the GCWR.</p>				
<p>Towing a trailer over 907 kg (2 000 lbs.) requires a weight distributing hitch.</p>				

Driving

Trailer towing table (4x4 manual transmission)				
GCWR (Gross Combined Weight Rating)/Trailer weights				
Engine	Rear axle ratio	Maximum GCWR-kg (lbs.)	Trailer weight range-kg (lbs.) (0-Maximum)	Maximum frontal area of trailer-m² (ft²)
2-door				
4.0L EFI	3.27	2 721 (6 000)	0-871 (0-1 920)	4.64 (50)
4.0L EFI	3.55	2 948 (6 500)	0-1 089 (0-2 420)	4.64 (50)
4.0L EFI	3.73	3 175 (7 000)	0-1 325 (0-2 920)	4.64 (50)
4-door				
4.0L EFI	3.55	2 948 (6 500)	0-998 (0-2 200)	4.64 (50)
4.0L EFI	3.73	3 175 (7 000)	0-1 225 (0-2 700)	4.64 (50)
<p>Notes: - For high altitude operation, reduce GCW by 2% per 300 meters (1 800 ft) elevation. For definitions of terms used in this table and instructions on how to calculate your vehicle load, refer to <i>Vehicle loading</i> in this chapter. Maximum trailer weights shown. The combined weight of the completed towing vehicle and the loaded trailer must not exceed the GCWR.</p>				
<p>Towing a trailer over 907 kg (2 000 lbs.) requires a weight distributing hitch.</p>				

Trailer towing table (4x2 automatic transmission)				
GCWR (Gross Combined Weight Rating)/Trailer weights				
Engine	Rear axle ratio	Maximum GCWR-kg (lbs.)	Trailer Weight Range-kg (lbs.) 0-Maximum	Maximum frontal area of trailer-m² (ft²)
2-door				
4.0L SOHC	3.27	3 402 (7 500)	0-1 361 (0-3 000)	4.64 (50)
4.0L SOHC	3.55	3 856 (8 500)	0-2 041 (0-4 500)	4.64 (50)
4.0L EFI	3.73	4 082 (9 000)	0-2 313 (0-5 100)	4.64 (50)
4.0L SOHC	3.73	4 082 (9 000)	0-2 041 (0-4 500)	4.64 (50)
4-door				
4.0L SOHC	3.55	4 082 (9 000)	0-2 041 (0-4 500)	4.64 (50)
4.0L EFI	3.73	4 309 (9 500)	0-2 449 (5 400)	4.64 (50)
4.0L SOHC	3.73	4 535 (10 000)	0-2 658 (0-5 860)	4.64 (50)
4.0L SOHC	4.10	4 535 (10 000)	0-2 630 (0-5 800)	4.64 (50)
5.0L	3.73	4 990 (11 000)	0-3 039 (0-6 700)	4.64 (50)
<p>Notes: For high altitude operation, reduce GCW by 2% per 300 meters (1 000 ft) elevation. For definition of terms and instructions on calculating your vehicle's load, refer to <i>Vehicle loading</i> in this chapter. Maximum trailer weights shown. The combined weight of the completed towing vehicle and the loaded trailer must not exceed the GCWR.</p>				
Towing a trailer over 907 kg (2 000 lbs.) requires a weight distributing hitch.				

Driving

Trailer towing table (4x4 and AWD with automatic transmission)				
GCWR (Gross Combined Weight Rating)/Trailer Weights				
Engine	Rear axle ratio	Maximum GCWR-kg (lbs.)	Trailer Weight Range-kg (lbs.) 0-Maximum	Maximum frontal area of trailer-m ² (ft ²)
2-door				
4.0L SOHC	3.27	3 402 (7 500)	0-1 524 (0-3 360)	4.64 (50)
4.0L SOHC	3.55	3 856 (8 500)	0-1 978 (0-4 360)	4.64 (50)
4.0L EFI	3.73	4 082 (9 000)	0-2 214 (0-4 880)	4.64 (50)
4.0L SOHC	3.73	4 082 (9 000)	0-2 204 (0-4 860)	4.64 (50)
4.0L EFI	4.10	4 082 (9 000)	0-2 214 (4 880)	4.64 (50)
4.0L SOHC	4.10	4 082 (9 000)	0-2 204 (4 860)	4.64 (50)
4-door				
4.0L SOHC	3.55	4 082 (9 000)	0-2 041 (0-4 500)	4.64 (50)
4.0L EFI	3.73	4 309 (9 500)	0-2 341 (0-5 160)	4.64 (50)
4.0L SOHC	3.73	4 535 (10 000)	0-2 558 (0-5 640)	4.64 (50)
4.0L SOHC	4.10	4 535 (10 000)	0-2 558 (0-5 640)	4.64 (50)
5.0L	3.73	4 990 (11 000)	0-2 930 (6 460)	4.64 (50)
<p>Notes: For high altitude operation, reduce GCW by 2% per 300 meters (1 000 ft) elevation. For definition of terms and instructions on calculating your vehicle's load, refer to <i>Vehicle loading</i> in this chapter. Maximum trailer weights shown. The combined weight of the completed towing vehicle and the loaded trailer must not exceed the GCWR.</p>				
Towing a trailer over 907 kg (2 000 lbs.) requires a weight distributing hitch.				



Do not exceed the GVWR or the GAWR specified on the Safety Compliance Certification Label.



Towing trailers beyond the maximum recommended gross trailer weight exceeds the limit of the vehicle and could result in engine damage, transmission damage, structural damage, loss of control, and personal injury.

Preparing to tow

Use the proper equipment for towing a trailer, and make sure it is properly attached to your vehicle. See your dealer or a reliable trailer dealer if you require assistance.

Hitches

Do not use hitches that clamp onto the vehicle bumper. Use a load carrying hitch. You must distribute the load in your trailer so that 10 – 15% of the total weight of the trailer is on the tongue.

Use a frame-mounted weight distributing hitch for trailers over 907 kg (2 000 lb).

Safety chains

Always connect the trailer's safety chains to the vehicle. To connect the trailer's safety chains, cross the chains under the trailer tongue and allow slack for turning corners.

If you use a rental trailer, follow the instructions that the rental agency gives to you.

Trailer brakes

Electric brakes and manual, automatic or surge-type brakes are safe if installed properly and adjusted to the manufacturer's specifications. The trailer brakes must meet local and Federal regulations.



Do not connect a trailer's hydraulic brake system directly to your vehicle's brake system. Your vehicle may not have enough braking power and your chances of having a collision greatly increase.

Driving

Trailer lamps

Trailer lamps are required on most towed vehicles. Make sure your trailer lamps conform to local and Federal regulations. See your dealer or trailer rental agency for proper instructions and equipment for hooking up trailer lamps.



Never connect any trailer lighting to the vehicle's taillamp circuits, because it may damage the electrical system resulting in fire. Contact your local Ford dealership for assistance in proper trailer tow wiring installation. Additional electrical equipment may be required.

Using a step bumper

The rear bumper is equipped with an integral hitch and requires only a ball with a 19 mm (3/4 inch) shank diameter. The bumper has a 1 590 kg (3 500 lb.) trailer weight and 159 kg (350 lb.) tongue weight capability.

Use a frame-mounted weight distributing hitch for trailers over 1 590 kg (3 500 lb.).

Driving while you tow

Do not drive faster than 88 km/h (55 mph) when towing a trailer.

Speed control may shut off if you are towing on long, steep grades.

When towing a trailer:

- Use a lower gear when towing up or down steep hills. This will eliminate excessive downshifting and upshifting for optimum fuel economy and transmission cooling.
- Anticipate stops and brake gradually.

Servicing after towing

If you tow a trailer for long distances, your vehicle will require more frequent service intervals. Refer to the Severe Duty Schedule in your "Service Guide" for more information.

Trailer towing tips

- Practice turning, stopping and backing up in an area before starting on a trip to get the feel of the vehicle trailer combination. When turning, make wider turns so the trailer wheels will clear curbs and other obstacles.

- Allow more distance for stopping with a trailer attached.
- The trailer tongue weight should be 10–15% of the loaded trailer weight.
- After you have traveled 80 km (50 miles), thoroughly check your hitch, electrical connections and trailer wheel lug nuts.
- When stopped in traffic for long periods of time in hot weather, place the gearshift in P (Park) (automatic transmissions) or 1 (First) (manual transmissions) and increase idle speed. This aids engine cooling and air conditioner efficiency.
- Vehicles with trailers should not be parked on a grade. If you must park on a grade, place wheel chocks under the trailer's wheels.

Launching or retrieving a boat

When backing down a ramp during boat launching or retrieval,

- Do not allow the static water level to rise above the bottom edge of the rear bumper and
- Do not allow waves to break higher than 15 cm (six inches) above the bottom edge of the rear bumper.

Exceeding these limits may allow water to enter critical vehicle components, adversely affecting driveability, emissions and reliability.

If the rear axle is submerged in water, the rear axle lubricant should be checked and changed, if necessary. The rear axle is filled with a synthetic lubricant and does not normally require a lubricant change for the life of the vehicle. Rear axle lubricant quantities should not need to be checked unless a leak is suspected.

Recreational towing (all wheels on the ground) (Neutral tow kit accessory)

On vehicles equipped with a 4.0L engine, an accessory is available that allows you to tow your vehicle, behind another vehicle, with all the wheels on the ground. Contact your dealer for more details. Do not tow your vehicle with all wheels on the ground unless you install the neutral tow kit as vehicle damage may occur.

LUGGAGE RACK

Maximum load is 45 kg (100 lbs), evenly distributed. If it is not possible to distribute the load, position it as far rearward as possible. Adjustable tie down loops must be used to secure the load.

Driving

To adjust cross-bar position:

1. Loosen the thumbwheel at both ends of the cross-bar (both cross-bars are adjustable).
2. Slide cross-bar to the desired location.
3. Tighten thumbwheel at both ends of the cross-bar.

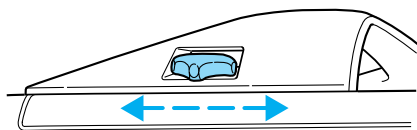

FUEL CONSUMPTION

Fuel economy can be improved by avoiding:

- lack of regular, scheduled maintenance.
- excessive speed.
- rapid acceleration.
- extended idle.

HAZARD LIGHTS CONTROL

Use only in an emergency to warn traffic of vehicle breakdown, approaching danger, etc. The hazard flashers can be operated when the ignition is off.

- The hazard lights control is located on top of the steering column.
- Depress hazard lights control to activate all hazard flashers simultaneously.
- Depress control again to turn the flashers off.

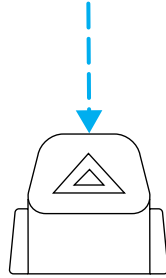

FUEL PUMP SHUT-OFF SWITCH

If the engine cranks but does not start after a collision, the fuel pump shut-off switch may have been activated. The “Fuel Reset” indicator light will illuminate in the instrument cluster. The shut-off switch is a device intended to stop the electric fuel pump when your vehicle has been involved in a substantial jolt.

1. Turn the ignition switch to the OFF position.
2. Check the fuel system for leaks.
3. If no fuel leak is apparent, reset the fuel pump shut-off switch by pushing in the button on the switch.
4. Turn the ignition switch to the ON position. Pause for a few seconds and return the key to the OFF position.
5. Make a further check for leaks in the fuel system.

Roadside emergencies

The fuel pump shut-off switch is located in the passenger's foot well, behind the kick panel.

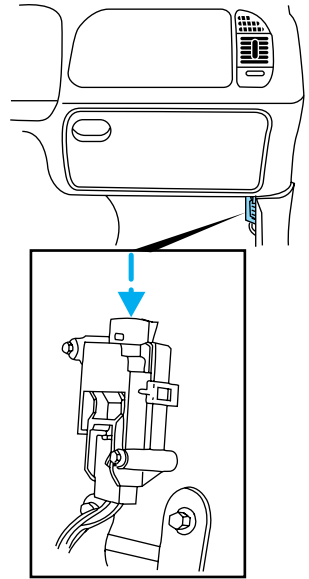

FUSES AND RELAYS

Fuses

If electrical components in the vehicle are not working, a fuse may have blown. Blown fuses are identified by a broken wire within the fuse. Check the appropriate fuses before replacing any electrical components.

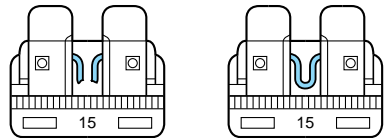

Always replace a fuse with one that has the specified amperage rating. Using a fuse with a higher amperage rating can cause severe wire damage and could start a fire.

Roadside emergencies

Standard fuse amperage rating and color

Fuse rating	Color
5 amp	Tan
7.5 amp	Brown
10 amp	Red
15 amp	Light blue
20 amp	Yellow
20 amp fuse link	Light blue
25 amp	Natural
30 amp	Light green
30 amp fuse link	Pink
40 amp fuse link	Green
50 amp fuse link	Red
60 amp fuse link	Yellow
80 amp fuse link	Black
100 amp fuse link	Dark blue

Roadside emergencies

Passenger compartment fuse panel

The fuse panel is located on the left hand side of the instrument panel facing the driver's side door. Pull the panel cover outward to access the fuses.

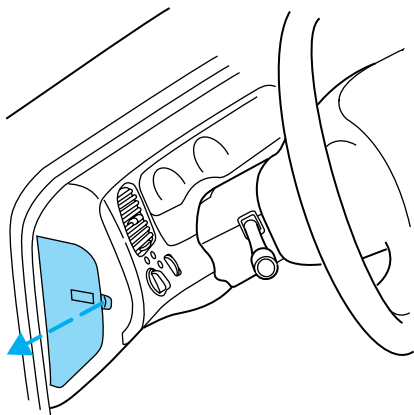

To remove a fuse use the fuse puller tool provided on the fuse panel cover.

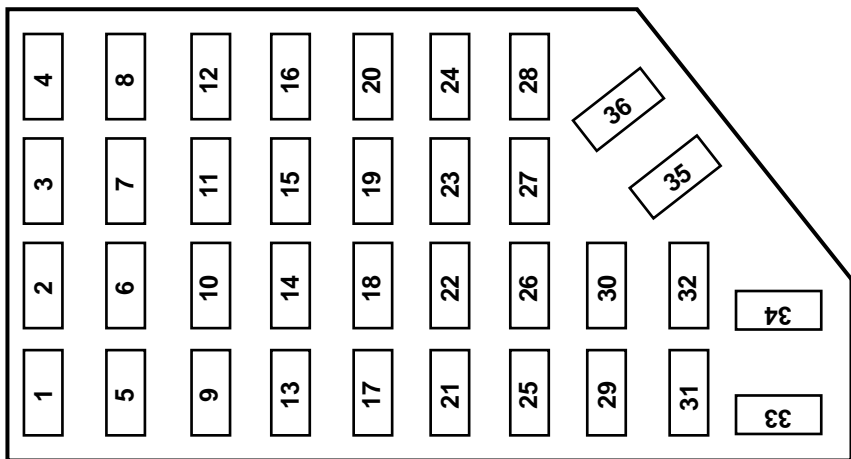

Roadside emergencies

The fuses are coded as follows:

Fuse/Relay Location	Fuse Amp Rating	Description
1	7.5A	Power Mirror Switch, Power Antenna
2	7.5A	Blower Motor Relay, Air Bag Diagnostic Monitor
3	7.5A	Left Stop/Turn Trailer Tow Connector
4	10A	Left Headlamp
5	10A	Data Link Connector (DLC)
6	7.5A	Rear Blower Motor (Without EATC)
7	7.5A	Right Stop/Turn Trailer Tow Connector
8	10A	Right Headlamp, Foglamp Relay
9	7.5A	Brake Pedal Position Switch
10	7.5A	Speed Control/Amplifier Assembly, Brake Pressure Switch, Generic electronic Module (GEM), Shift Lock Actuator, Blend Door Actuator, A/C - Heater Assembly, Flasher
11	7.5A	Instrument Cluster
12	7.5A	Power Window Relay, Washer Pump Relay
13	20A	Brake Pedal Position Switch, Brake Pressure Switch
14	10A	4 Wheel Anti-Lock Brake System (4WABS) Module, 4WABS Main Relay
15	7.5A	Instrument Cluster
16	30A	Windshield Wiper Motor, Wiper Hi-Lo Relay, Wiper Run/Park Relay
17	25A	Cigar Lighter
18	25A	Drivers Unlock Relay, All Unlock Relay, All Lock Relay
19	25A	PCM Power Diode
20	7.5A	RAP Module, Generic Electronic Module (GEM), Radio, Cellular Phone

Roadside emergencies

Fuse/Relay Location	Fuse Amp Rating	Description
21	15A	Flasher (Hazard)
22	20A	Auxiliary Power Socket
23	-	NOT USED
24	7.5A	Clutch Pedal Position (CPP) Switch, Starter Interrupt Relay, Anti-Theft
25	7.5A	Generic Electronic Module (GEM), Instrument Cluster, Securi-Lock
26	10A	Battery Saver Relay, Electronic Shift Relay, Interior Lamp Relay, Power Window Relay, Electronic Shift Control Module
27	15A	DRL, Backup Lamps Switch, DTR Sensor, GEM, Electric Shift
28	7.5A	Generic Electronic Module (GEM), Radio, Memory Seat
29	25A	Radio
30	15A	Park Lamp/Trailer Tow Relay
31	-	NOT USED
32	10A	Heated Mirror
33	15A	Headlamps, Daytime Running Lamps (DRL) Module, Instrument Cluster
34	7.5A	Rear Integrated Control Panel, CD
35	7.5A	Rear Blower Motor (With EATC)
36	7.5A	EATC Memory, CD, Rear Integrated Control Panel, Memory Seat, Message Center

Roadside emergencies

Power distribution box

The power distribution box is located in the engine compartment near the battery. The power distribution box contains high-current fuses that protect your vehicle's main electrical systems from overloads.

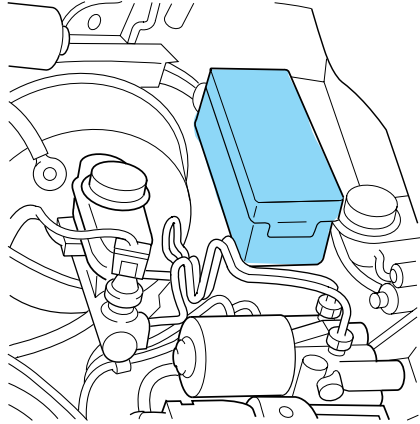

Always disconnect the battery before servicing high current fuses.



Always replace the cover to the Power Distribution Box before reconnecting the battery or refilling fluid reservoirs.

Roadside emergencies

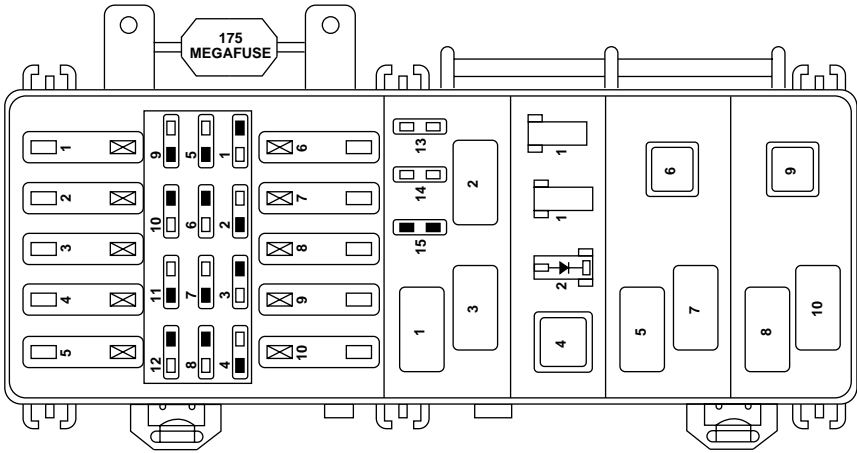

The high-current fuses are coded as follows:

Fuse/Relay Location	Fuse Amp Rating	Description
1	60A**	I/P Fuse Panel
2	40A**	Blower Motor Relay
3	50A**	4 Wheel Anti-Lock Brake System (4WABS) Module
4	30A**	Power Windows, Power Moon Roof, Power Seat
5	50A**	Ignition Switch, Starter Relay
6	20A**	Transfer Case Relay
7	—	NOT USED
8	20A**	Automatic Ride Control ARC Switch Off/On Switch
9	40A**	Automatic Ride Control Relay
10	30A**	PCM Power Relay
1	10A*	A/C Relay

Roadside emergencies

Fuse/Relay Location	Fuse Amp Rating	Description
2	-	NOT USED
3	30A*	Heated Backlight
4	15A*	Fog Lamps and Daytime Running Lamps
5	10A*	Air Bag Diagnostic Monitor
6	10A*	Powertrain Control Module
7	30A*	4 Wheel Anti-Lock System (4WABS) Module
8	15A*	Rear Wiper Motor
9	20A*	Fuel Pump Relay and RAP Module
10	15A*	Horn Relay
11	15A*	Parklamps Relay and Mainlight Switch
12	30A*	Mainlight Switch and Multifunction Switch
13	15A*	Heated Oxygen Sensor, EGR Vacuum Regulator, EVR Solenoid, Camshaft Position (CMP) Sensor, Canister Vent Solenoid
14	30A*	Generator/Voltage Regulator
15	-	NOT USED
1	-	Wiper Park Relay
2	-	A/C Relay
3	-	Wiper High/Low Relay
4	-	PCM Power Relay
5	-	Fuel Pump Relay
6	-	Starter Relay
7	-	Horn Relay
8	-	Rear Wipe Down Relay
9	-	Blower Motor Relay
10	-	Rear Wipe Up Relay
1	-	NOT USED
1	-	NOT USED
2	-	Electronic Engine Controls Diode

* Mini Fuses ** Maxi Fuses ¹ 5.0L Engines Only

Roadside emergencies

CHANGING THE TIRES

If you get a flat tire while driving, do not apply the brake heavily. Instead, gradually decrease your speed. Hold the steering wheel firmly and slowly move to a safe place on the side of the road.

Spare tire information

Your vehicle is equipped with a spare tire that may be used as a spare or a regular tire. The spare tire is not equipped with wheel trim. The wheel trim from the original wheel/tire may be used on the spare.

If your vehicle is equipped with 4WD or AWD, a spare tire of a different size than the road tires should not be used. Such a tire could result in damage to driveline components and make the vehicle difficult to control.

Location of the spare tire and tools

The spare tire and tools for your vehicle are stowed in the following locations:

Tool	Location
Spare tire	Under the vehicle, just in front of the rear bumper
Jack, lug nut wrench	Left rear quarter panel behind interior trim
Jack handle	Behind rear seats, under carpet

Removing the spare tire

1. Insert the jack handle into the rear bumper opening.

The handle will stop moving and forward resistance to turning will be felt when properly engaged.

2. Turn the handle counterclockwise until tire is lowered to the ground, the tire can be slid rearward and the cable is slightly slack.

3. Remove the retainer from the spare tire.

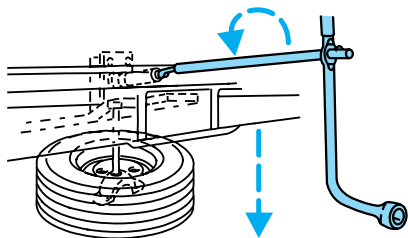

Stowing the spare

1. Lay the tire on the ground with the valve stem facing up.
2. Slide the wheel under the vehicle and install the retainer through the wheel center.
3. Turn the jack handle clockwise until the tire is raised to its original position underneath the vehicle. The jack handle ratchets when the tire is raised to the stowed position. It will not allow you to overtighten.

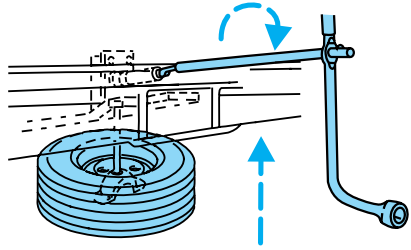

Tire change procedure



On vehicles equipped with Air Suspension, turn OFF the Air Suspension switch prior to jacking, hoisting or towing your vehicle.

Refer to the instruction sheet for detailed tire change instructions.

1. Park on a level surface, activate hazard flashers and set the parking brake.
2. Place gearshift lever in P (Park) or in the reverse gear (manual transmission).

When one of the rear wheels is off the ground, the transmission alone will not prevent the vehicle from moving or slipping off the jack, even if the transmission is in P (Park) (automatic transmission) or reverse (manual transmission).

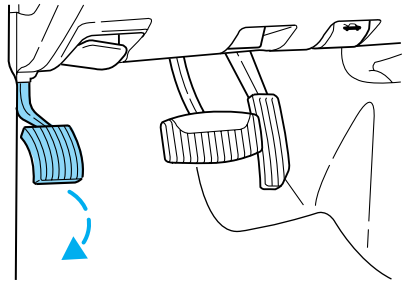

Roadside emergencies

3. Block the diagonally opposite wheel.
4. Use the tip of the lug wrench to remove any wheel trim.

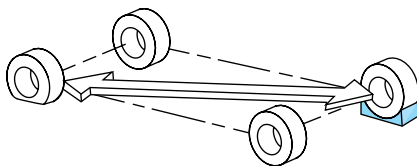

5. Loosen each wheel lug nut, but do not remove them until the wheel is raised off the ground.

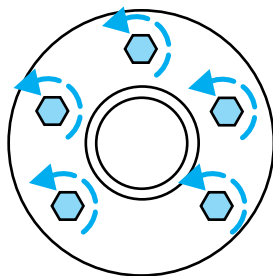

6. Turn OFF the air suspension switch (if equipped). Refer to *Air suspension system* in the *Driving* chapter.

7. Position the jack according to the following guides and turn the jack handle clockwise until the tire is a maximum of 25 mm (1 inch) off the ground.

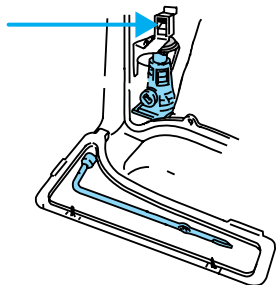

Roadside emergencies

- Front

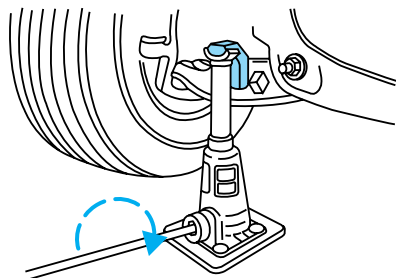

- Rear

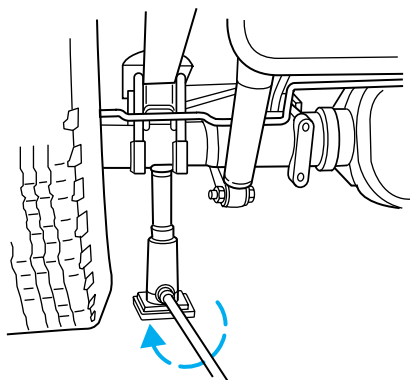

Roadside emergencies

- **Never use the front or rear differential as a jacking point.**

8. Remove the lug nuts with the lug wrench.

9. Replace the flat tire with the spare tire, making sure the valve stem is facing outward. Reinstall the lug nuts, cone side in, until the wheel is snug against the hub. Do not fully tighten the lug nuts until the wheel has been lowered.

10. Lower the wheel by turning the jack handle counterclockwise.

11. Remove the jack and fully tighten the lug nuts in the order shown.

12. Stow the flat tire, jack and lug wrench. Make sure the jack is fastened so it does not rattle when you drive.

13. Turn ON the air suspension switch (if equipped).

14. Unblock the wheels.

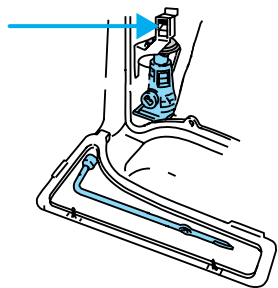
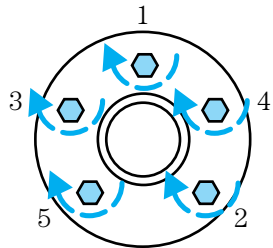
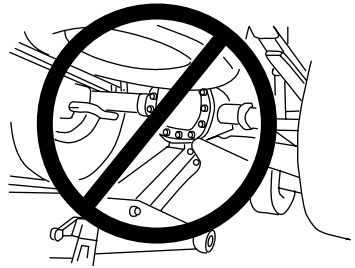

Roadside emergencies

JUMP STARTING YOUR VEHICLE



The gases around the battery can explode if exposed to flames, sparks, or lit cigarettes. An explosion could result in injury or vehicle damage.



Do not push start your vehicle. You could damage the catalytic converter.



Batteries contain sulfuric acid which burns skin, eyes, and clothing.

Preparing your vehicle

Also see the label on the battery.

1. Use only a 12-volt supply to start your vehicle. If you connect your battery to a 24-volt power supply you can damage your starter, ignition system and other electrical components.
2. Do not disconnect the battery of the disabled vehicle as this could damage the vehicle's electrical system.
3. Park the booster vehicle close to the hood of the disabled vehicle making sure they **do not** touch. Set the parking brake on both vehicles and stay clear of the engine cooling fan and other moving parts.
4. Check all battery terminals and remove any excessive corrosion before you attach the battery cables.
5. Turn the heater fan on in both vehicles to protect any electrical surges. Turn all other accessories off.

Connecting the jumper cables

1. Position the vehicles so that they do not touch one another.
2. Switch off the engine. Switch off any unnecessary electrical equipment.
3. Connect the positive (+) terminal of the discharged battery (1) to the positive (+) terminal of the booster battery (2).
4. Connect one end of the second lead to the negative (-) terminal of the booster battery (3) and the other end to a metal part of the engine to be started (4), not to the negative (-) terminal of the discharged battery.

Roadside emergencies

- 4.0L SOHC

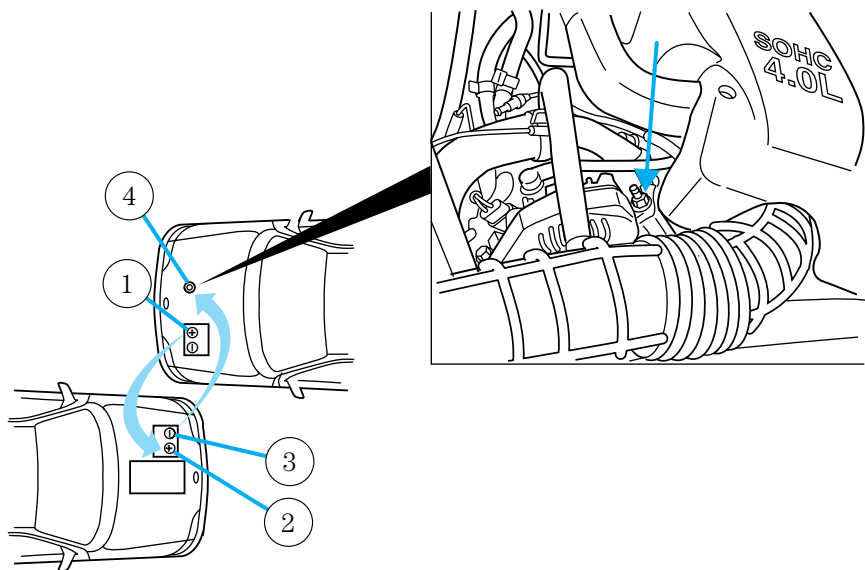

Roadside emergencies

- except 4.0L SOHC

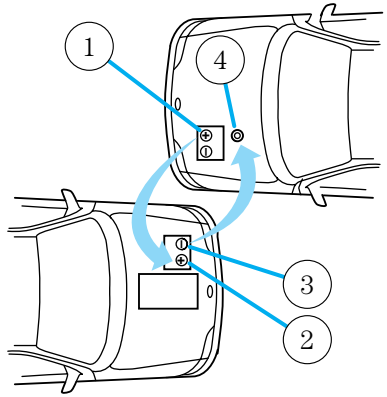

5. Make sure that the jump leads are clear of moving parts of the engine.



Do not connect the end of the second cable to the negative (-) terminal of the battery to be jumped. A spark may cause an explosion of the gases that surround the battery.

Jump starting

1. Start the booster vehicle and run the engine at moderately increased speed.
2. Start the engine of the vehicle with the discharged battery.
3. Once the engine has been started, run both vehicles for a further three minutes before disconnecting the leads.

Removing the jumper cables

1. Remove the jumper cables in reverse order. Take the cable off the metallic surface (1) first, followed by the cable on the negative (-) booster battery terminal (2).
2. Remove the cable from the positive (+) terminal of the booster battery (3) and then the discharged battery (4).

Roadside emergencies

- 4.0L SOHC

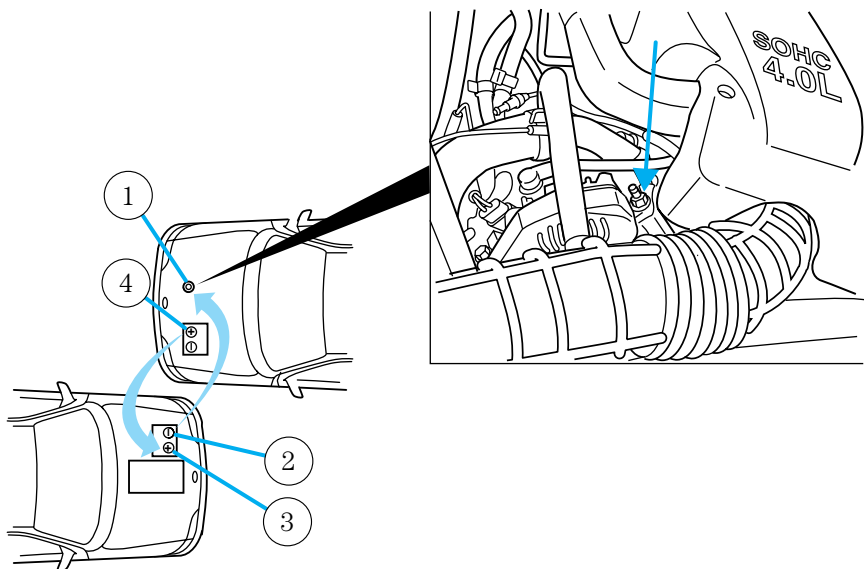

Roadside emergencies

- except 4.0L SOHC

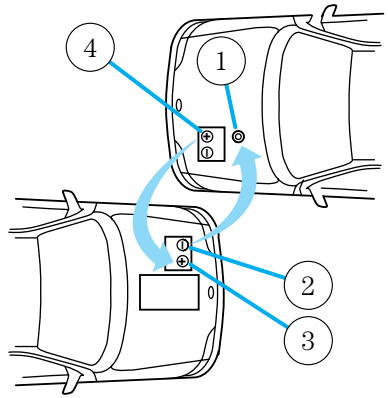

3. After the disabled vehicle has been started, allow it to idle for a while so the engine can “relearn” its idle conditions.

Roadside emergencies

WRECKER TOWING

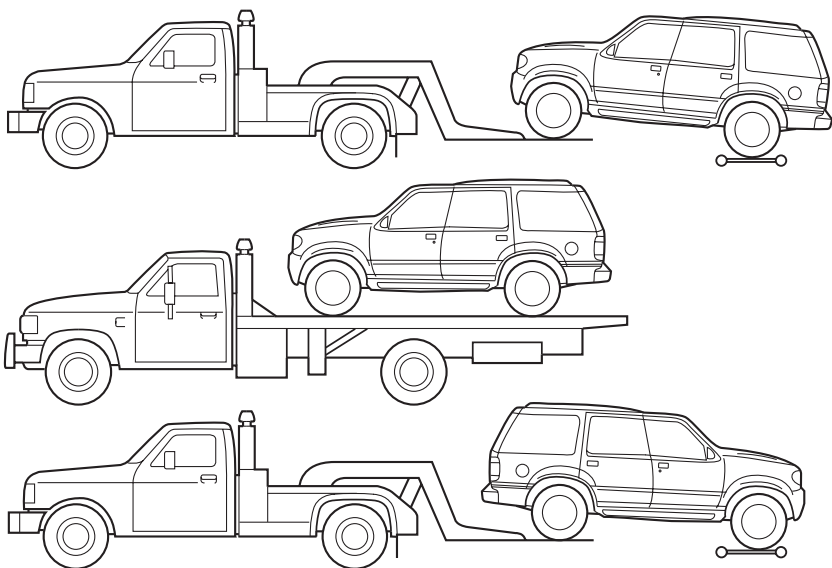

If you need to have your vehicle towed, contact a professional towing service or, if you are a member, your roadside assistance center.

If equipped with air suspension, the air suspension control must be turned to the OFF position.

The Ford approved towing procedure is flatbed or wheel lift with dollies.

On 4x2 vehicles, it is acceptable to tow the vehicle with the front wheels on the ground (without dollies) and the rear wheels off the ground.

If the vehicle is towed by other means or incorrectly, vehicle damage may occur.

Do not tow with slingbelt equipment. Ford Motor Company has not developed or approved a slingbelt towing procedure.

Roadside emergencies

When calling for a tow truck, tell the operator what kind of vehicle you have. A towing manual is available from Ford Motor Company for all authorized tow truck operators. Have your tow truck driver refer to this manual for proper hook-up and towing procedures for your vehicle.

Maintenance and care

SERVICE RECOMMENDATIONS

To help you service your vehicle:

- We highlight do-it-yourself items in the engine compartment for easy location.
- We provide a “Service Guide” which makes tracking routine service easy.

If your vehicle requires professional service, your dealership can provide necessary parts and service. Check your “Warranty Guide” to find out which parts and services are covered.

Use only recommended fuels, lubricants, fluids and service parts conforming to specifications. Motorcraft parts are designed and built to provide the best performance in your vehicle.

PRECAUTIONS WHEN SERVICING YOUR VEHICLE

Be especially careful when inspecting or servicing your vehicle.

- Do not work on a hot engine.
- When the engine is running, make sure that loose clothing, jewelry or long hair does not get caught up in moving parts.
- Do not work on a vehicle with the engine running in an enclosed space, unless you are sure you have enough ventilation.
- Keep all lit cigarettes, open flames and other lit material away from the battery and all fuel related parts.

If you disconnect the battery, the engine must “relearn” its idle conditions before your vehicle will drive properly, as explained in *Battery* in this chapter.

Working with the engine off

- Automatic transmission:

1. Set the parking brake and ensure the gearshift is securely latched in P (Park).
2. Turn off the engine and remove the key.
3. Block the wheels to prevent the vehicle from moving unexpectedly.

- Manual transmission:

1. Set the parking brake.
2. Depress the clutch and place the gearshift in 1 (First).

3. Turn off the engine and remove the key.
4. Block the wheels to prevent the vehicle from moving unexpectedly.

Working with the engine on

- Automatic transmission:
 1. Set the parking brake and ensure the gearshift is securely latched in P (Park).
 2. Block the wheels to prevent the vehicle from moving unexpectedly.



Do not start your engine with the air cleaner removed and do not remove it while the engine is running.

- Manual transmission:
 1. Set the parking brake, depress the clutch and place the gearshift in N (Neutral).
 2. Block the wheels to prevent the vehicle from moving unexpectedly.



Do not start your engine with the air cleaner removed and do not remove it while the engine is running.

OPENING THE HOOD

1. Inside the vehicle, pull the hood release handle located under the steering column on the instrument panel.
2. Go to the front of the vehicle and release the auxiliary latch that is located under the front center of the hood. Lift the hood until the lift cylinders hold it open.

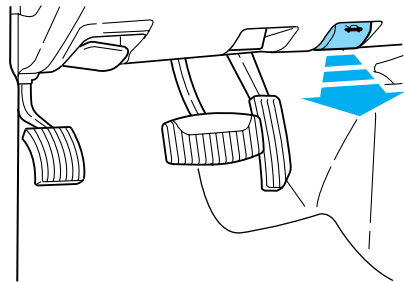

Maintenance and care

IDENTIFYING COMPONENTS IN THE ENGINE COMPARTMENT

4.0L EFI engine

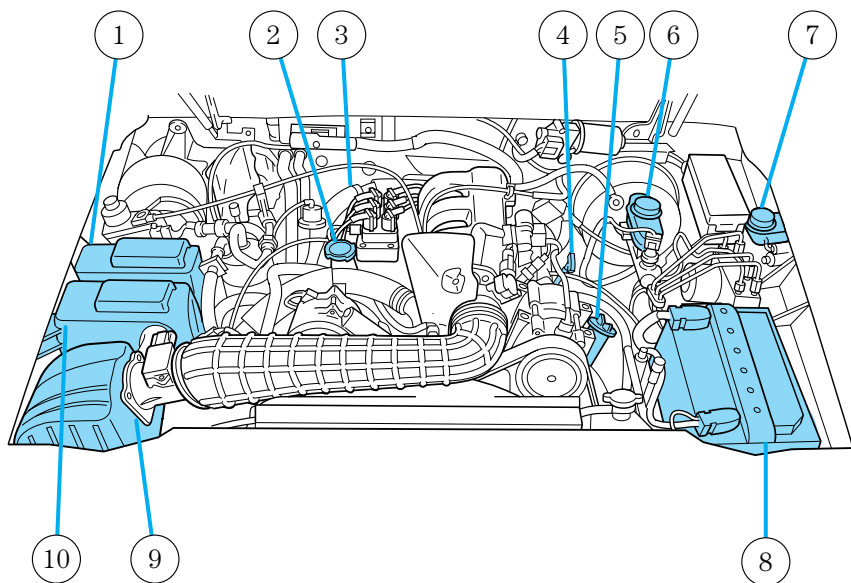

1. Windshield washer fluid reservoir
2. Engine oil fill cap
3. Transmission fluid dipstick (automatic transmission only)
4. Engine oil dipstick
5. Power steering fluid reservoir
6. Brake fluid reservoir
7. Clutch fluid reservoir (manual transmission only)
8. Battery
9. Air filter assembly
10. Engine coolant reservoir

4.0L SOHC engine

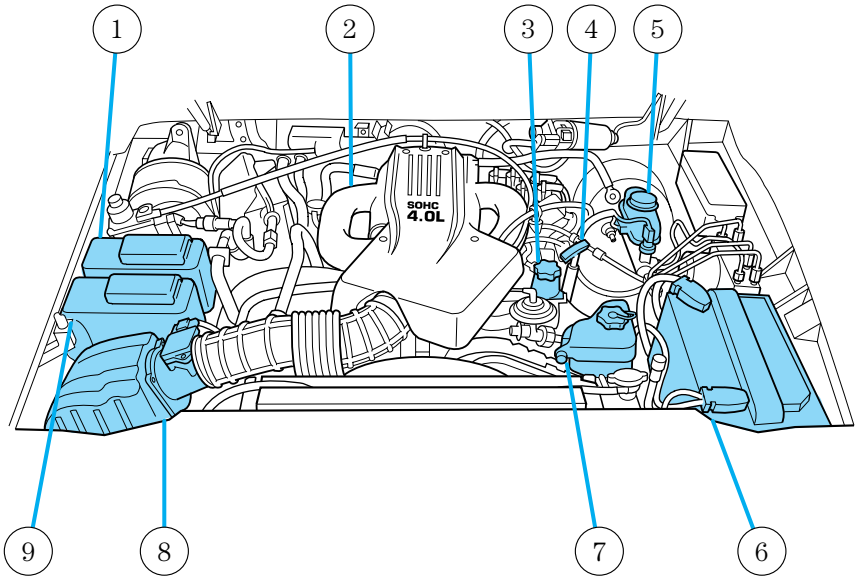

1. Windshield washer fluid reservoir
2. Transmission fluid dipstick
3. Engine oil fill cap
4. Engine oil dipstick
5. Brake fluid reservoir
6. Battery
7. Power steering fluid reservoir
8. Air filter assembly
9. Engine coolant reservoir

Maintenance and care

5.0L engine

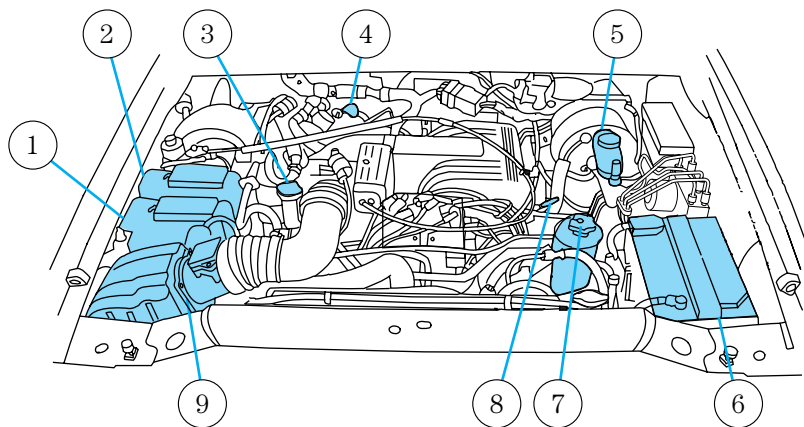

1. Engine coolant reservoir
2. Windshield washer fluid reservoir
3. Engine oil fill cap
4. Automatic transmission fluid dipstick
5. Brake fluid reservoir
6. Battery
7. Power steering fluid reservoir
8. Engine oil dipstick
9. Air filter assembly

ENGINE OIL

Checking the engine oil

Check the engine oil each time you fuel your vehicle.

1. Make sure the vehicle is on level ground.
2. Turn the engine off and wait a few minutes for the oil to drain into the oil pan.

Maintenance and care

3. Set the parking brake and ensure the gearshift is securely latched in P (Park) (automatic transmissions) or 1 (First) (manual transmissions).
 4. Open the hood. Protect yourself from engine heat.
 5. Locate and carefully remove the engine oil level indicator (dipstick).
- 4.0L engines

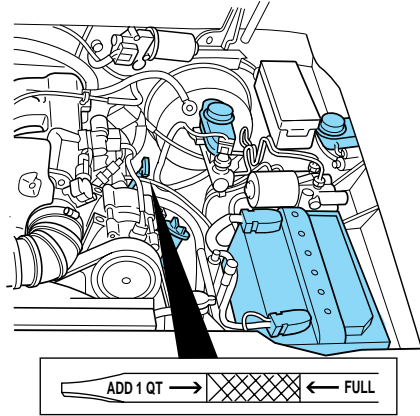

- 5.0L engine

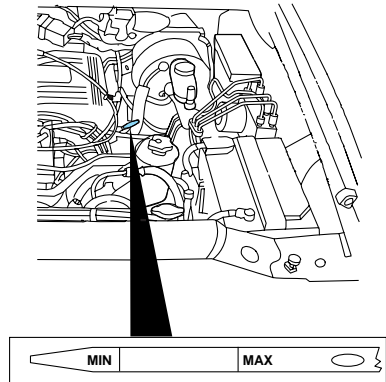

6. Wipe the indicator clean. Insert the indicator fully, then remove it again.

Maintenance and care

- If the oil level is **between the ADD and FULL marks (4.0L engines)** or **between the MIN and MAX marks (5.0L engines)** the oil level is acceptable. **DO NOT ADD OIL.**
- If the oil level is below the ADD mark (4.0L engines) or MIN mark (5.0L engines), add enough oil to raise the level within the ADD-FULL range (4.0L engines) or MIN-MAX range (5.0L engines).

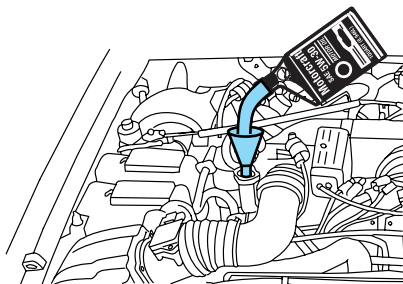

- Oil levels above the letter F in FULL (4.0L engines) or the MAX mark (5.0L engines) may cause engine damage. Some oil must be removed from the engine by a service technician.
7. Put the indicator back in and ensure it is fully seated.

Adding engine oil

1. Check the engine oil. For instructions, refer to *Checking the engine oil* in this chapter.
2. If the fluid level is not within the normal range, add only certified engine oil of the preferred viscosity. Add engine oil through the oil filler cap. Remove the filler cap and use a funnel to pour oil in the opening.
3. Recheck the oil level. Make sure the oil level is not above the MAX mark or the letter F in FULL on the dipstick.

Engine oil recommendations

Look for this certification mark.

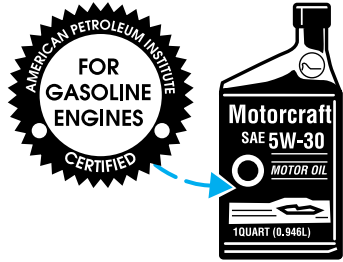

Ford oil specification is WSS-M2C153-G.

Use SAE 5W-30 motor oil certified for gasoline engines by the American Petroleum Institute.

Do not use supplemental engine oil additives, oil treatments or engine treatments. They are unnecessary and could, under certain conditions, lead to engine damage which is not covered by your warranty.

Changing the engine oil and filter

Change your engine oil and filter according to the following mileage and time requirements, whichever occurs first:

- Normal Schedule – 8,000 km (5,000 miles) or six months.
- Severe Duty Schedule - 5,000 km (3,000 miles) or three months.
Severe duty operation would include extensive idling, trailer towing, driving in severe dust and police, taxi or delivery service.

Ford production and aftermarket (Motorcraft) oil filters are designed for added engine protection and long life. If a replacement oil filter is used that does not meet Ford material and design specifications, startup engine noises or knock may be experienced.

It is recommended you use the appropriate Motorcraft oil filter (or another brand meeting Ford specifications) for your engine application.

Maintenance and care

BRAKE FLUID

Checking and adding brake fluid

Brake fluid should be checked and refilled as needed at least once each year:

1. Clean the reservoir cap before removal to prevent dirt or water from entering the reservoir.
2. Visually inspect the fluid level.
3. If necessary, add brake fluid until the level reaches MAX. Do not fill above this line.
4. Use only a DOT 3 brake fluid certified to meet Ford specifications. Refer to *Lubricant specifications* in the *Capacities and specifications* chapter.

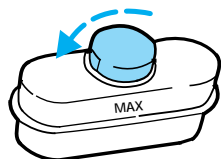
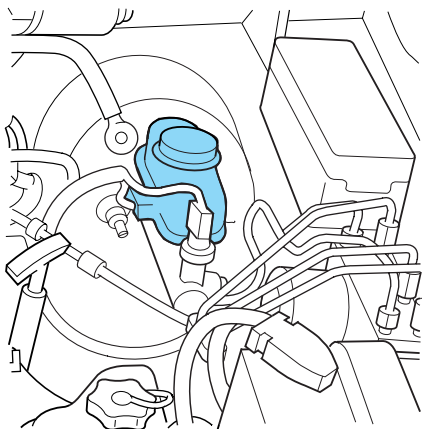

Brake fluid is toxic.



If you use a brake fluid that is not DOT 3, you will cause permanent damage to your brakes.



Do not let the reservoir for the master cylinder run dry. This may cause the brakes to fail.

CLUTCH FLUID (IF EQUIPPED)

During normal operation, the fluid level in the clutch reservoir will slowly rise. If the fluid level drops, maintain the fluid level at the step in the reservoir.

Use only a DOT 3 brake fluid designed to meet Ford specifications. Refer to *Capacities and specifications*.

1. Clean the reservoir cap before removal to prevent dirt and water from entering the reservoir.
2. Remove cap.
3. Add fluid until the level reaches the FULL line.

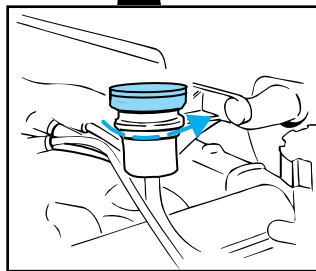
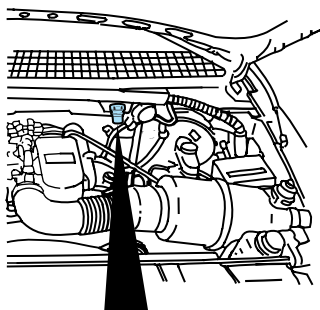

Maintenance and care

WINDSHIELD WASHER FLUID

Checking and adding washer fluid

Check the washer fluid whenever you stop for fuel. The reservoir is highlighted with a  symbol.

If the level is low, add enough fluid to fill the reservoir. In very cold weather, do not fill the reservoir all the way.

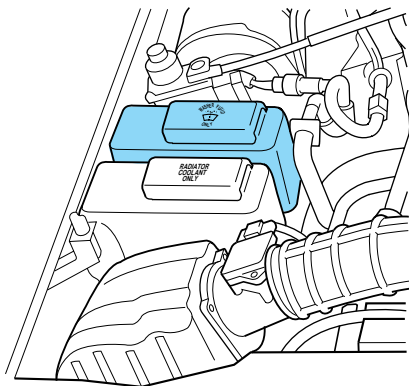

Do not put engine coolant in the container for the windshield washer fluid.

ENGINE COOLANT

Check the level of the coolant in the reservoir at least once a month. Be sure to read and understand *Precautions when servicing your vehicle* in this chapter.

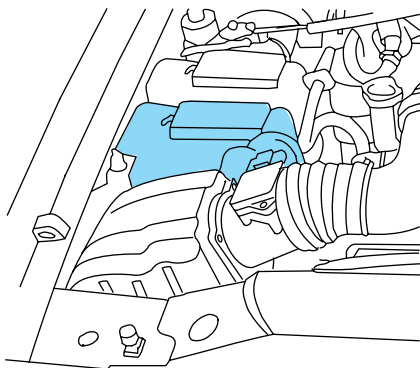

Maintenance and care

If the engine coolant has not been checked for a long period of time, the engine coolant reservoir may eventually empty. If this occurs, add engine coolant to the coolant reservoir. For more information on engine coolant maintenance, refer to *Adding engine coolant* in this chapter.

Automotive fluids are not interchangeable; do not use engine coolant, antifreeze or windshield washer fluid outside of its specified function and vehicle location.

Adding engine coolant



Do not put engine coolant in the container for the windshield washer fluid.

If sprayed on the windshield, engine coolant could make it difficult to see through the windshield.

When the engine is cool, add a 50/50 mixture of engine coolant and water to the engine coolant recovery reservoir-**DO NOT ADD DIRECTLY TO THE RADIATOR**. Add straight water only in an emergency, but you should replace it with a 50/50 mixture of coolant and distilled water as soon as possible.

Check the coolant level in the coolant recovery reservoir the next few times you drive the vehicle. If necessary, add enough of a 50/50 mixture of coolant and water to bring the liquid level to the fill line on the reservoir.



Never remove the coolant recovery cap while the engine is running or hot.

If you must remove the coolant recovery cap, follow these steps to avoid personal injury:

1. Before you remove the cap, turn the engine off and let it cool.
2. When the engine is cool, wrap a thick cloth around the cap. Slowly turn cap counterclockwise until pressure begins to release.
3. Step back while the pressure releases.
4. When you are sure that all the pressure has been released, use the cloth to turn it counterclockwise and remove the cap.

Use Ford Premium Cooling System Fluid E2FZ-19549-AA (in Canada, Motorcraft CXC-8-B) or an equivalent premium engine coolant that

Maintenance and care

meets Ford specification ESE-M97B44–A. Ford Premium Engine Coolant is an optimized formula that will protect all metals and rubber elastomers used in Ford cooling systems for four years or 80,000 km (50,000 miles).

Do not use alcohol or methanol antifreeze or any engine coolants mixed with alcohol or methanol antifreeze. Do not use supplemental coolant additives in your vehicle. These additives may harm your engine cooling system. The use of an improper coolant may void your warranty of your vehicle's engine cooling system.

Recycled engine coolant

Ford Motor Company recommends that Ford and Lincoln-Mercury dealers use recycled engine coolant produced by Ford-approved processes. Not all coolant recycling processes produce coolant which meets Ford specification ESE-M97B44–A, and use of such coolant may harm engine and cooling system components.



Always dispose of used automotive fluids in a responsible manner. Follow your community's regulations and standards for recycling and disposing of automotive fluids.

Coolant refill capacity

To find out how much fluid your vehicle's cooling system can hold, refer to *Refill capacities* in the *Capacities and specifications* chapter.

Have your dealer check the engine cooling system for leaks if you have to add more than a liter (quart) of engine coolant per month.

Severe winter climate

If you drive in extremely cold climates (less than -36°C [-34°F]), it may be necessary to increase the coolant concentration above 50%. Refer to the chart on the coolant container to ensure the coolant concentration in your vehicle is such that the coolant will not freeze at the temperature level in which you drive during winter months. Never increase the engine coolant concentration above 60%. Leave a 50/50 mixture of engine coolant and water in your vehicle year-round in non-extreme climates.

Maintenance and care

CHECKING AND ADDING POWER STEERING FLUID

Check the power steering fluid at least twice a year. If adding fluid is necessary, use only MERCON® ATF power steering fluid.

- 4.0L EFI engine

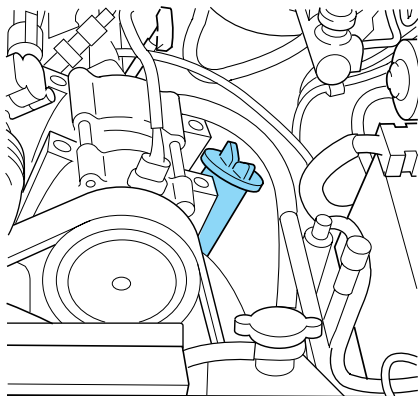

- 4.0L SOHC engine

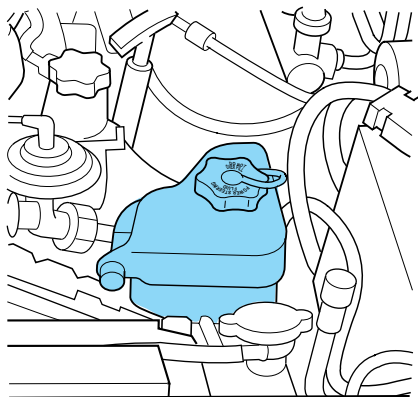

Maintenance and care

- 5.0L engine

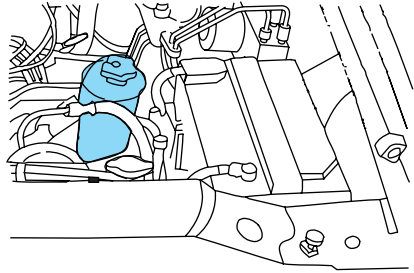

1. Start the engine and let it run until it reaches normal operating temperature (the engine coolant temperature gauge will be near the center of the NORMAL band).
2. While the engine idles, turn the steering wheel left and right several times.
3. Turn the engine off.
4. Check the fluid level in the reservoir.
5. **If your vehicle is equipped with a 4.0L EFI engine**, the fluid level should be in the FULL HOT range. Do not add fluid if the level is in this range.
6. **If your vehicle is equipped with a 4.0L SOHC engine or a 5.0L engine**, the fluid level should be between the MIN and MAX lines. Do not add fluid if the level is in this range.
7. If the fluid is low, add fluid in small amounts, continuously checking the level until it reaches the correct operating range. Be sure to put the cap back on the reservoir.

TRANSMISSION FLUID

Checking and adding automatic transmission fluid

Follow the scheduled service intervals outlined in the “Service Guide”.

Before adding any fluid, make sure the correct type is used. The type of fluid used is normally indicated on the dipstick and/or dipstick handle and also in the *Lubricant specifications* section in the *Capacities and specifications* chapter.

Maintenance and care

An overflow condition of transmission fluid may cause shift and/or engagement concerns and/or possible damage.

Do not drive the vehicle if the fluid level is below the bottom hole on the dipstick and outside temperatures are above 10°C (50°F) (see figure to the right).

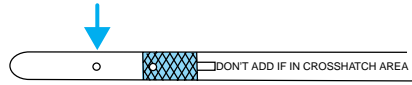

Your transmission does not use up fluid. However, it is recommended that you check the transmission fluid at least twice a year. The fluid level should be checked if the transmission is not working properly, i.e., if the transmission slips or shifts slowly or if you notice some sign of fluid leakage.

Transmission fluid should be checked at normal operating temperatures 66°C-77°C (150°F-170°F) on a level surface. The normal operating temperature can be reached after approximately 32 km (20 miles) of driving.

The transmission fluid should be in this range if at normal operating temperature (66°C-77°C [150°F-170°F]) (see figure to the right).

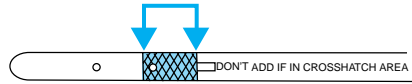

The transmission fluid should be in this range if at room temperature (10°C-35°C [50°F-95°F]) (see figure to the right).

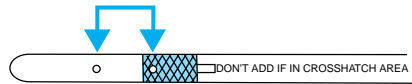

If your vehicle has been operated for an extended period at high speeds, in city traffic during hot weather or pulling a trailer, the vehicle should be turned off for about 30 minutes to allow the fluid to cool before checking.

1. Park the vehicle on a level surface and engage the parking brake.

Maintenance and care

2. With the parking brake engaged and your foot on the brake pedal, start the engine and move the gearshift lever through all of the gear ranges. Allow sufficient time for each gear to engage.

3. Latch the gearshift lever in P (Park) and leave the engine running.

4. Remove the dipstick, wiping it clean with a clean, dry lint free rag.

5. Install the dipstick making sure it is fully seated in the filler tube.

6. Remove the dipstick and inspect the fluid level. The fluid level should be within the top hole area on the dipstick.

7. If necessary, add fluid in 250ml (1/2 pint) increments through the filler tube until the level is correct.

8. If an overfill occurs, excess fluid should be removed by a qualified technician.

An overfill condition of transmission fluid may cause shift and/or engagement concerns and/or possible damage.

If the fluid level is above the crosshatch (hot operating range) area after driving the vehicle for approximately 30 km (20 miles), excess transmission fluid should be removed by a qualified technician.



Checking and adding manual transmission fluid

1. Clean the filler plug.
2. Remove the filler plug and inspect the fluid level.

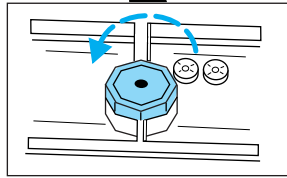
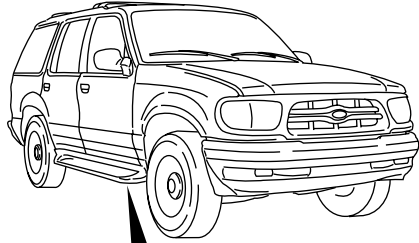

3. Fluid level should be at bottom of the opening.
4. Add enough fluid through the filler opening so that the fluid level is at the bottom of the opening.
5. Install and tighten the fill plug.

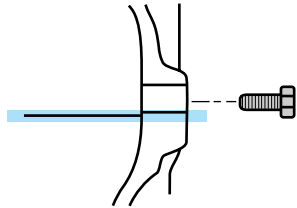

Use only fluid that meets Ford specifications. Refer to the *Capacities and specifications* chapter.

Maintenance and care

Checking and adding transfer case fluid

1. Clean the filler plug.
2. Remove the filler plug and inspect the fluid level.

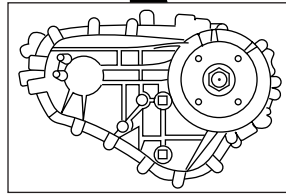
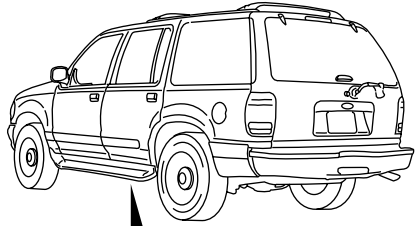

3. Add only enough fluid through the filler opening so that the fluid level is at the bottom of the opening.

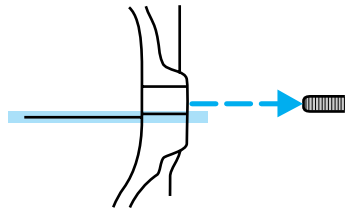

Use only fluid that meets Ford specifications. Refer to the *Capacities and specifications* chapter.

DRIVELINE UNIVERSAL JOINT AND SLIP YOKE

The universal joints standard with your vehicle do not require lubrication. If the original universal joints are replaced with universal joints equipped with grease fittings, lubrication will be necessary.

BATTERY

Your vehicle may be equipped with a Superstart maintenance-free battery. If the original equipment battery needs replacing, it may be replaced with a low-maintenance battery. The low-maintenance battery normally does not require additional water during its life of service. However, for severe usage or in high temperature climates, check your battery electrolyte level, at least every 24 months or 40,000 km (24,000 miles). Keep the electrolyte in each cell up to the "level" indicator. Do not overfill the battery cells.

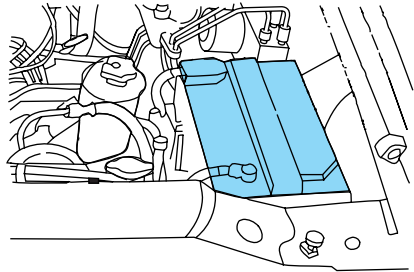

If the electrolyte level in the battery is low, you can add plain tap water to the battery, as long as you do not use hard water (water with a high alkali content). If possible, however, try to only fill the battery cells with distilled water. If the battery needs water often, have the charging system checked.

For longer, trouble-free operation, keep the top of the battery clean and dry. Also, make certain the battery cables are always tightly fastened to the battery terminals.

If you see any corrosion on the battery or terminals, remove the cables from the terminal(s) and clean with a wire brush. You can neutralize the acid with a solution of baking soda and water. Reinstall the cables when you are done cleaning them, and apply a small quantity of grease to the top of each battery terminal to help prevent corrosion.

If your battery has a cover/shield, make sure it is reinstalled after the battery is replaced.

Because your vehicle's engine is electronically controlled by a computer, some control conditions are maintained by power from the battery. When the battery is disconnected or a new battery is installed, the engine must

Maintenance and care

relearn its idle conditions before your vehicle will drive properly. To begin this process:

1. Put the gearshift in P (Park) (automatic transmissions) or the neutral position (manual transmissions), turn off all accessories and start the vehicle.
 2. Let the engine idle for at least one minute.
 3. The relearning process will automatically complete as you drive the vehicle.
- If you do not allow the engine to relearn its idle, the idle quality of your vehicle may be adversely affected until the idle is eventually relearned.
 - If the battery has been disconnected or a new battery has been installed, the clock and the preset radio stations must be reset once the battery is reconnected.
 - Always dispose of automotive batteries in a responsible manner. Follow your community's standards for disposal. Call your local recycling center to find out more about recycling automotive batteries.



WINDSHIELD WIPER BLADES

Check the wiper blades at least twice a year or when they seem less effective. Substances such as tree sap and some hot wax treatments used by commercial car washes reduce the effectiveness of wiper blades.

Checking the wiper blades

If the wiper blades do not wipe properly, clean both the windshield and wiper blades using undiluted windshield wiper solution or a mild detergent. Rinse thoroughly with clean water. To avoid damaging the blades, do not use fuel, kerosene, paint thinner or other solvents.

Changing the wiper blades

When replacing wiper blade assemblies, always use a Motorcraft part or equivalent. To make replacing the wipers easy, turn the ignition to ACC, then turn the wipers on. When the wipers reach the vertical position, turn the ignition to LOCK.

To replace the wiper blades:

1. Pull the wiper arm away from the windshield and lock into the service position.
2. Turn the blade at an angle from the wiper arm. Push the lock pin with a screwdriver to release the blade and pull the wiper blade down toward the windshield to remove it from the arm.
3. Attach the new wiper to the wiper arm and press it into place until a click is heard.

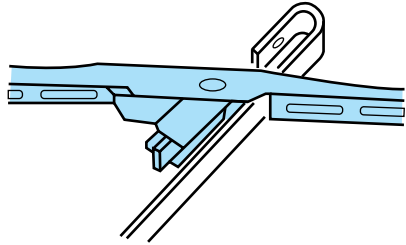

INFORMATION ABOUT TIRE QUALITY GRADES

New vehicles are fitted with tires that have their Tire Quality Grade (described below) molded into the tire's sidewall. These Tire Quality Grades are determined by standards that the United States Department of Transportation has set.

Tire Quality Grades apply to new pneumatic tires for use on passenger cars. They do not apply to deep tread, winter-type snow tires, space-saver or temporary use spare tires, tires with nominal rim diameters of 10 to 12 inches or limited production tires as defined in Title 49 Code of Federal Regulations Part 575.104(c)(2).

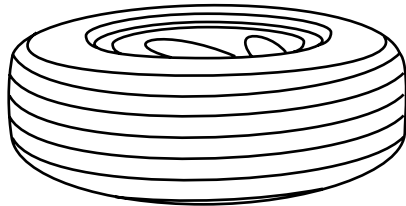

U.S. Department of Transportation-Tire quality grades: The U.S. Department of Transportation requires Ford to give you the following information about tire grades exactly as the government has written it.

Treadwear

The treadwear grade is a comparative rating based on the wear rate of the tire when tested under controlled conditions on a specified government test course. For example, a tire grade 150 would wear one and one-half (1 1/2) times as well on the government course as a tire

Maintenance and care

grade 100. The relative performance of tires depends upon the actual conditions of their use, however, and may depart significantly from the norm due to variations in driving habits, service practices, and differences in road characteristics and climate.

Traction A B C

The traction grades, from highest to lowest are A, B, and C, and they represent the tire's ability to stop on wet pavement as measured under test surfaces of asphalt and concrete. A tire marked C may have poor traction performance.



The traction grade assigned to this tire is based on braking (straight ahead) traction tests and does not include cornering (turning) traction.

Temperature A B C

The temperature grades are A (the highest), B, and C, representing the tire's resistance to the generation of heat and its ability to dissipate heat when tested under controlled conditions on a specified indoor laboratory test wheel. Sustained high temperature can cause the material of the tire to degenerate and reduce tire life, and excessive temperature can lead to sudden tire failure. The grade C corresponds to a level of performance which all passenger car tires must meet under the Federal Motor Vehicle Safety Standard No. 109. Grades B and A represent higher levels of performance on the laboratory test wheel than the minimum required by law.



The temperature grade for this tire is established for a tire that is properly inflated and not overloaded. Excessive speed, underinflation, or excessive loading, either separately or in combination, can cause heat buildup and possible tire failure.

SERVICING YOUR TIRES

Checking the tire pressure

- Use an accurate tire pressure gauge.
- Check the tire pressure when tires are cold, after the vehicle has been parked for at least one hour or has been driven less than 5 km (3 miles).

Maintenance and care

- Adjust tire pressure to recommended specifications found on the Tire Pressure Label.



Improperly inflated tires can affect vehicle handling and can fail suddenly, possibly resulting in loss of vehicle control.

Tire rotation

Because your vehicle's tires perform different jobs, they often wear differently. To make sure your tires wear evenly and last longer, rotate them as indicated in the "Service Guide". If you notice that the tires wear unevenly, have them checked.

- Four tire rotation

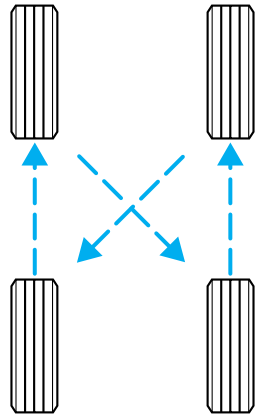

Maintenance and care

- Five tire rotation

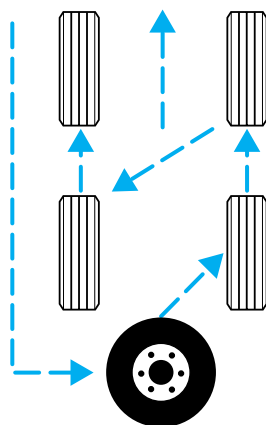

Replacing the tires

Replace the tires when the wear band is visible through the tire treads.

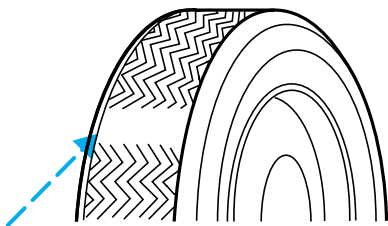

When replacing full size tires, never mix radial, bias-belted, or bias-type tires. Use only the tire sizes that are listed on the tire pressure decal. Make sure that all tires are the same size, speed rating, and load-carrying capacity. Use only the tire combinations recommended on the decal. If you do not follow these precautions, your vehicle may not drive properly and safely.

Maintenance and care



Make sure that all replacement tires are of the same size, type, load-carrying capacity and tread design (e.g., “All Terrain”, etc.), as originally offered by Ford.



Failure to follow these precautions may adversely affect the handling of the vehicle and make it easier to lose control and roll over.

Tires that are larger or smaller than your vehicle’s original tires may also affect the accuracy of your speedometer.

USING SNOW TIRES AND TRACTION DEVICES



Snow tires must be the same size and grade as the tires you currently have on your vehicle.

The tires on your vehicle have all-weather treads to provide traction in rain and snow. However, in some climates, using snow tires and traction devices may be necessary. Ford offers tire cables as a Ford approved accessory and recommends use of these or their equivalents. See your dealer or qualified service technician for more information on tire cables for your vehicle.

Follow these guidelines when using snow tires and traction devices:

- Do not use tire chains on aluminum wheels. Chains may chip the wheels.
- Install cables securely, verifying that the cables do not touch any wiring, brake lines or fuel lines.
- Drive cautiously. If you hear the cables rub or bang against the vehicle, stop and retighten them. If this does not work, remove the cables to prevent vehicle damage.
- Avoid overloading your vehicle.
- Remove the tire cables when they are no longer needed.
- Do not use cables on dry roads.
- The suspension insulation and bumpers will help prevent vehicle damage. Do not remove these components from the vehicle when using snow tires and traction devices.
- Do not exceed 48 km/h (30 mph) with tire cables on your vehicle.

Maintenance and care

Consult your dealer for information on other Ford approved methods of traction control.

WHAT YOU SHOULD KNOW ABOUT AUTOMOTIVE FUELS

Important safety precautions



Do not overfill the fuel tank. The pressure in an overfilled tank may cause leakage and lead to fuel spray and fire.



If you do not use the proper fuel cap, the pressure in the fuel tank can damage the fuel system or cause it to work improperly in a collision.



The fuel system may be under pressure. If the fuel cap is venting vapor or if you hear a hissing sound, wait until it stops before completely removing the cap.



Automotive fuels can cause serious injury or death if misused or mishandled.

Observe the following guidelines when handling automotive fuel:

- Extinguish all smoking materials and any open flames before fueling your vehicle.
- Always turn off the vehicle before fueling.
- Automotive fuels can be harmful or fatal if swallowed. If fuel is swallowed, call a physician immediately, even if no symptoms are immediately apparent. The toxic effects of fuel may not be visible for hours.
- Fuels can also be harmful if absorbed through the skin. If fuel is splashed on the skin, promptly remove contaminated clothing and wash skin thoroughly with soap and water.



Maintenance and care

- If fuel is splashed in the eyes, remove contact lenses, flush with water for 15 minutes and seek medical attention.
- Be particularly careful if you are taking “Antabuse” or other forms of disulfiram for the treatment of alcoholism. Breathing gasoline vapors or skin contact could cause an adverse reaction. Consult a physician immediately.

Choosing the right fuel

Use only UNLEADED FUEL. The use of leaded fuel is prohibited by law and could damage your vehicle.

Your vehicle was not designed to use fuel or fuel additives with metallic compounds, including manganese-based compounds containing MMT.

Vehicles certified to California emission standards (indicated on the underhood Vehicle Emissions Control Information label) are designed to operate on California reformulated gasolines. If California reformulated gasoline is not available when you refuel, your vehicle can be operated on non-California fuels. However, even though your engine will perform adequately on other gasolines, the performance of the emission control devices and systems may be adversely affected.

Repair of damage caused by using a fuel that your vehicle was not designed for may not be covered by your warranty.

Octane recommendations

Your vehicle is designed to use “Regular” unleaded with an (R+M)/2 octane rating of 87. We do not recommend gasolines labeled as “Regular” in high altitude areas that are sold with octane ratings of 86 or even less.

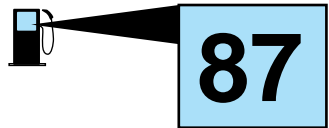

Do not be concerned if your vehicle sometimes knocks lightly. However, if it knocks heavily under most driving conditions on fuel with the

Maintenance and care

recommended octane, see your dealer or a qualified service technician to prevent any engine damage.

Fuel quality

If you are experiencing starting, rough idle or hesitation driveability problems during a cold start, try a different brand of “Regular” gasoline. “Premium” gasoline is not recommended (particularly in the United States) because it may cause these problems to become more pronounced. If the problems persist, see your dealer or a qualified service technician.

The American Automobile Manufacturers Association (AAMA) issued a gasoline specification to provide information on high quality fuels that optimize the performance of your vehicle. We recommend the use of gasolines that meet the AAMA specification if they are available.

It should not be necessary to add any aftermarket products to your fuel tank if you continue to use a high-quality fuel.

Cleaner air

Ford approves the use of gasolines to improve air quality, including reformulated gasolines that contain oxygenates up to 10% ethanol or 15% MTBE.

Do not use gasolines containing methanol, which can damage critical fuel system components. Damage resulting from the use of methanol may not be covered by your warranty.

Calculating fuel economy

To accurately calculate your vehicle’s fuel economy:

1. Fill the tank completely and record the initial odometer reading.
2. Each time you fill the tank, record the amount of fuel added (in liters or gallons).
3. After at least three to five fuel tank fill-ups, fill the fuel tank and record the current mileage reading.
4. Use one of the following equations to calculate fuel economy.

Liters used \times 100 \div Total kilometers traveled

Total miles traveled \div Total gallons used

Keep a record for at least one month. This will provide an accurate estimate of the vehicle’s fuel economy.

EMISSION CONTROL SYSTEM

Your vehicle is equipped with various emission control components and a catalytic converter which will enable your vehicle to comply with applicable exhaust emission standards. To make sure that the catalytic converter and other emission control components continue to work properly:

- Use only unleaded fuel.
- Avoid running out of fuel.
- Do not turn off the ignition while your vehicle is moving, especially at high speeds.
- Have the services listed in your “Service Guide” performed according to the specified schedule.

The Scheduled Maintenance Services listed in the “Service Guide” are required because they are considered essential to the life and performance of your vehicle and to its emissions system.

If other than Ford, Motorcraft or Ford authorized parts are used for maintenance replacements or for service of components affecting emission control such non-Ford parts should be equivalent to genuine Ford Motor Company parts in performance and durability.



Do not park, idle, or drive your vehicle in dry grass or other dry ground cover. The emission system heats up the engine compartment and exhaust system, which can start a fire.

Watch for fluid leaks, strange odors, smoke, loss of oil pressure, the charging system warning light, the “Check Engine” light or the temperature warning light. These events could indicate that the emission control system is not working properly.



If you smell exhaust fumes of any kind inside your vehicle, have the dealer inspect and fix your vehicle immediately. Do not drive if you smell exhaust fumes. These fumes are harmful and could kill you.

Do not make any unauthorized changes to your vehicle or engine. By law, vehicle owners and anyone who manufactures, repairs, services, sells, leases, trades vehicles, or supervises a fleet of vehicles are not permitted to intentionally remove an emission control device or prevent it from working. Information about your vehicle’s emission system is on

Maintenance and care

the Vehicle Emission Control Information Decal located on or near the engine. This decal identifies engine displacement and gives some tune up specifications.

Please consult your “Warranty Guide” for complete emission warranty information.

Readiness for inspection/maintenance (I/M) testing

In some localities, it may be a legal requirement to pass an I/M test of the on-board diagnostic (OBD-II) system. If your “check engine/service engine soon” light is on, reference the applicable light description in the *Warning Lights and Chimes* section of your owners guide. Your vehicle may not pass the I/M test with the “check engine/service engine soon” light on.

If the vehicle’s powertrain system or its battery has just been serviced, the OBD-II system is reset to a “not ready for I/M test” condition. To ready the OBD-II system for I/M testing, a minimum of 30 minutes of city and highway driving is necessary as described below:

- First, at least 10 minutes of driving on an expressway or highway.
- Next, at least 20 minutes driving in stop and go, city type traffic with at least four idle periods.

Allow the vehicle to sit for at least eight hours without starting the engine. Then, start the engine and complete the above driving cycle. The engine must warm up to its normal operating temperature. Once started, do not turn off the engine until the above driving cycle is complete.

EXTERIOR BULBS

Replacing exterior bulbs

Check the operation of the following lamps frequently:

- headlamps
- foglamps
- high-mount brakelamp
- brakelamps
- turn signals
- license plate lamp
- tail lamps

Maintenance and care

- back-up lamps

Do not remove lamp bulbs unless they can be replaced immediately with new ones. If a bulb is removed for an extended period of time, contaminants may enter the lamp housings and affect lamp performance.

Replacing headlamp bulbs



Handle a halogen headlamp bulb carefully and keep out of children's reach. Grasp the bulb only by its plastic base and do not touch the glass. The oil from your hand could cause the bulb to break the next time the headlamps are operated.

If the bulb is accidentally touched, it should be cleaned with rubbing alcohol before being used.

To remove the headlamp bulb:

1. Make sure headlamp switch is in OFF position, then open the hood. If you are replacing the driver side headlamp, unclip the electronic module on the right side of the battery and move it out of the way.
2. Locate the headlamp bulb through the hole in the upper radiator support assembly.
3. Disconnect the electrical connector from the bulb by pulling the connector rearward.

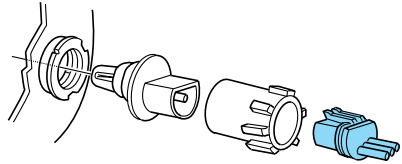

4. Remove the bulb retaining ring by rotating it counterclockwise (when viewed from the rear) about an eighth of a turn to free it from the bulb socket, and by sliding the ring off the plastic base. Keep the ring because it will be used again to retain the new bulb.

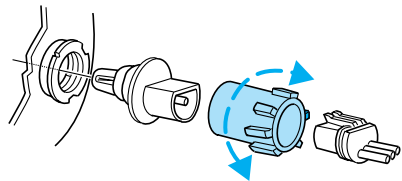

Maintenance and care

5. Remove the old bulb from its socket by gently pulling it straight back out of the socket. Do not turn the bulb while removing it.

To install the new bulb:

1. With the flat side of the bulb's plastic base facing upward, insert the glass end of the bulb into the socket. You may need to turn the bulb left or right to line up the grooves in the plastic base with the tabs in the socket. When the grooves are aligned, push the bulb into the socket until the plastic base contacts the rear of the socket.

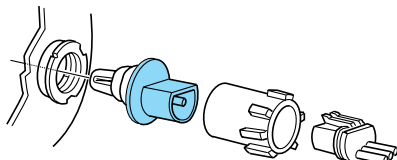

2. Slip the bulb retaining ring over the plastic base until it contacts the rear of the socket by rotating it clockwise until you feel a “stop”.

3. Push the electrical connector into the rear of the plastic base until it snaps, locking it into position.

4. Turn the headlamps on and make sure they work properly. If the headlamp was correctly aligned before you changed the bulb, you should not need to align it again.

Bulb specifications

Function	Number of bulbs	Trade number
Park/turn lamps (front)	4	3156 NAK
Headlamps	2	9007
Rear stop/tail lamps	2	3157K
Rear turn lamps	2	3156K
Rear license plate lamps	2	3156
Backup lamp	2	3156K
Rear/turn/sidemarker	2	916NA
Cargo lamp	1	211-2
Interior overhead lamp	1	912 (906)
Front door courtesy lamp	1	168
Map lamps	2	168 (T10)
Ashtray lamp	1	161
To replace all instrument panel lights - see your dealer.		

AIMING THE HEADLAMPS

Your vehicle is equipped with a Vehicle Headlamp Aim Device (VHAD) on each headlamp. Each headlamp may be properly aimed in the vertical (up/down) and the horizontal (left/right) directions using your VHAD system. The headlamps on your vehicle are properly aimed at the assembly plant, and vertical and horizontal indicators of the VHAD system are calibrated.

A bubble (vertical indicator) that is not centered between the two red lines does not necessarily indicate out-of-aim headlamps. If your vehicle is not positioned on a level surface, the slope will be included in the vertical indication. Therefore, vertical and horizontal headlamp adjustment should be performed only when the beam direction appears to be incorrect.

You will need one 4 mm wrench or socket with ratchet to make the adjustments.

The following procedure assumes that the factory set horizontal indicator reference has not changed and the vehicle's front structure is in its factory alignment condition. If the vehicle has been in an accident requiring the front end of the vehicle to be repaired, the horizontal indicator should be recalibrated by the servicing facility according to instructions in the vehicle's Workshop Manual.

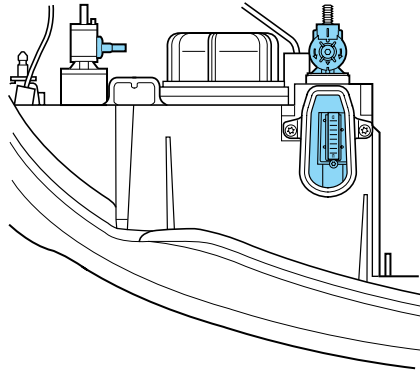

Maintenance and care

Horizontal aim adjustment

1. With the hood open, locate the horizontal indicator and adjusting screw. They are located below the viewing hole at the rear of the headlamp assembly.
2. Use a 4mm wrench or socket to turn the horizontal adjusting screw until the "0" mark on the yellow dial lines up with the reference mark on the marker (as shown) when viewed directly from above.

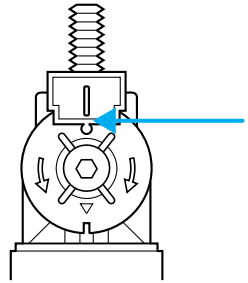

Vertical aim adjustment

1. Park the vehicle on a level surface.
2. With the hood open, locate the bubble level and vertical adjustment screw. The adjustment screw is located on the outboard side of the headlamp.

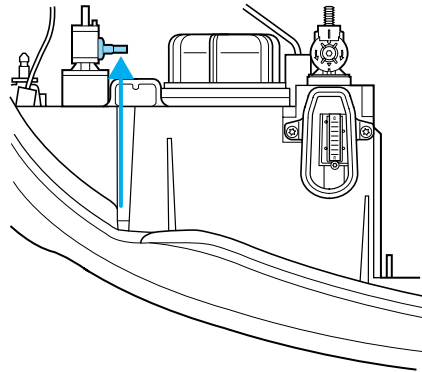

Maintenance and care

3. The “UP” and “DN” on the bubble indicate the directional change (up or down) of the vertical aim.

4. Use a 4 mm wrench or socket to turn the vertical adjusting screw clockwise or counterclockwise until the bubble is centered over the “0” mark.

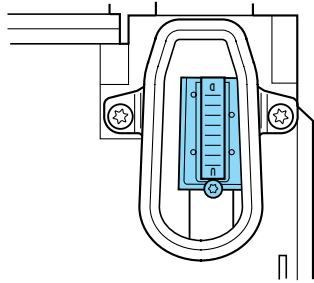

Repeat the above process to the other headlamp, if necessary.

CLEANING AND CARING FOR YOUR VEHICLE

Refer to the “Customer Assistance Guide” for a list of Ford-approved cleaners, polishes and waxes.

Washing your vehicle

Wash your vehicle regularly with cold or lukewarm water. Never use strong detergents or soap. If your vehicle is particularly dirty, use a quality car wash detergent. Always use a clean sponge, washing glove or similar device and plenty of water for best results. To avoid spots, avoid washing when the hood is still warm, immediately after or during exposure to strong sunlight.

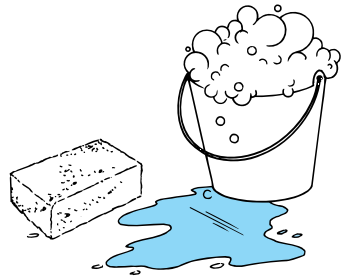

During winter months, it is especially important to wash the vehicle on a regular basis. Large quantities of dirt and road salt are difficult to remove and also cause damage to the vehicle. Remove any exterior accessories, such as antennas, before entering a car wash.

After washing, apply the brakes several times to dry them.

Maintenance and care

Waxing your vehicle

Wax when water stops beading on the surface. This could be every three or four months, depending on operating conditions.

Use only carnauba or synthetic-based waxes. Remove any bugs and tar before waxing vehicle. Use cleaning fluid or alcohol with a clean cloth to remove. Use tar remover to remove any tar spots.

Repairing paint chips

Minor scratches or paint damage from road debris may be repaired with touch-up paint, repair foil or aerosol paint spray from the Ford accessory line. Observe the application instructions on the products.

Remove particles such as bird droppings, tree sap, insect remains, tar spots, road salt and industrial fallout immediately.

Cleaning the engine

Engines are more efficient when they are clean because grease and dirt buildup keep the engine warmer than normal. When washing:

- Take care when using a power washer to clean the engine. The high pressure fluid could penetrate the sealed parts and cause damage.
- Do not spray with cold water to avoid cracking the engine block or other engine components.
- Cover the highlighted areas to prevent water damage when cleaning the engine.

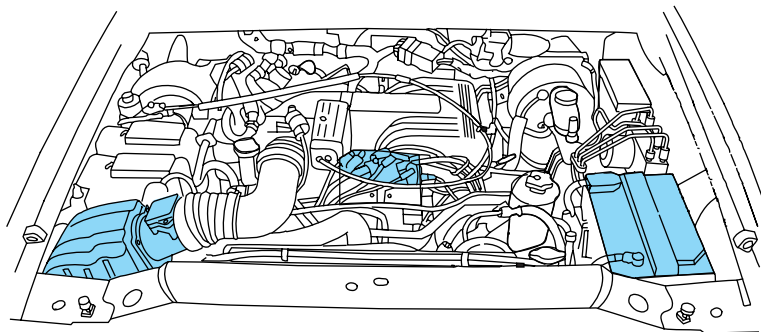

Maintenance and care

- 5.0L

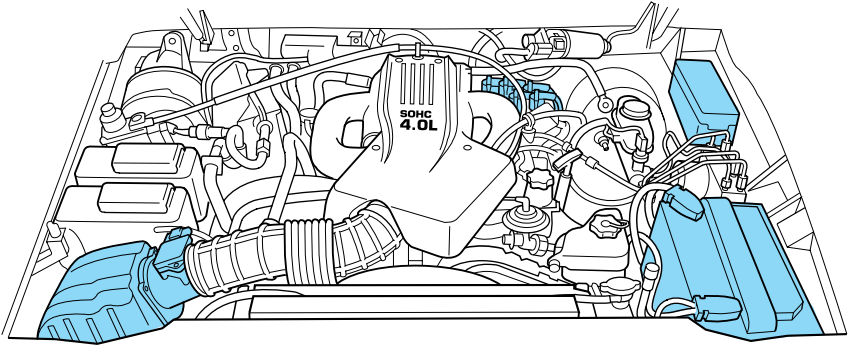

- 4.0L SOHC

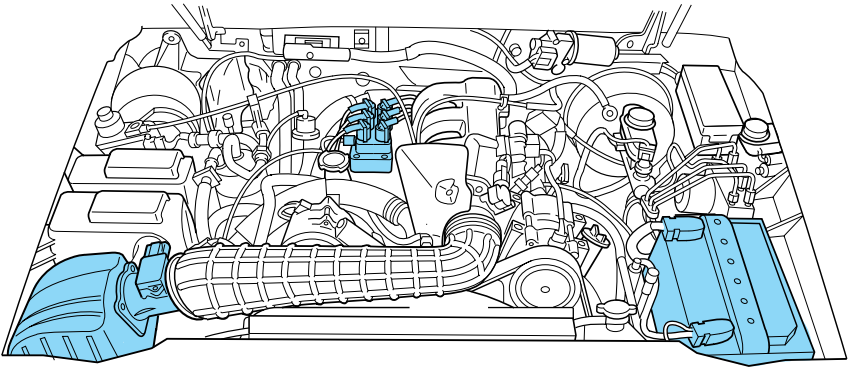

- 4.0L EFI
- Never wash or rinse the engine while it is running; water in the running engine may cause internal damage.

Maintenance and care

Cleaning the wheels

Wash with the same detergent as the body of your vehicle. Do not use acid-based wheel cleaners, steel wool, fuel or strong detergents. Never use abrasives that will damage the finish of special wheel surfaces. Use a tar remover to remove grease and tar.

Cleaning plastic exterior parts

Use vinyl cleaner for routine cleaning. Clean with a tar remover if necessary. Do not clean plastic parts with thinners, solvents or petroleum-based cleaners.

Cleaning the exterior lamps

Wash with the same detergent as the exterior of your vehicle. Use glass cleaner or tar remover if necessary.

To avoid scratching the lamps, do not use a dry paper towel, chemical solvents or abrasive cleaners.

Cleaning the wiper blades

If the wiper blades do not wipe properly, clean the windshield and wiper blades with undiluted windshield wiper solution or a mild detergent. Rinse thoroughly with clean water. To avoid damaging the blades, do not use fuel, kerosene, paint thinner or other solvents.

Cleaning the instrument panel

Clean with a damp cloth, then dry with a dry cloth.

Avoid cleaner or polish that increases the gloss of the upper portion of the instrument panel. The dull finish in this area helps protect the driver from undesirable windshield reflection.

Cleaning the interior fabric

Remove dust and loose dirt with a whisk broom or a vacuum cleaner. Remove fresh spots immediately. Follow the directions that come with the cleaner.

Cleaning and maintaining the safety belts

Clean the safety belts with a mild soap solution recommended for cleaning upholstery or carpets. Do not bleach or dye the belts, because these actions may weaken the belt webbing.

Check the safety belt system periodically to make sure there are no nicks, wear or cuts. If your vehicle has been involved in an accident, refer to the *Safety belt maintenance* section in the *Seating and safety restraints* chapter.

Cleaning the built-in child seat (if equipped)

Clean with mild soap and water. Do not use household cleaning products because they may weaken the safety belt webbing or damage the vinyl parts of the seat.

The child seat liner is removable and may be machine-washed and air dried.

Underbody

Flush the complete underside of vehicle frequently. Keep body drain holes unplugged. Inspect for road damage.

Cleaning leather seats (if equipped)

For routine cleaning, wipe the surface with a soft, damp cloth. For more thorough cleaning, wipe the surface with a mild soap.

If the leather cannot be completely cleaned using a mild soap and water solution, the leather may be cleaned using a commercially available cleaning product “Tanners Preserve Leather Cleaner” and a 3M “Type T” scrubbing pad by using the following steps;

The type of scrubbing pad is very critical because the common 3M “Scotch Brite” green pad is too aggressive and will damage the leather surface

- Spray a small amount of the leather cleaner on the pad and rub the area to be cleaned with the pad using a circular motion. Only clean 1/4 of the area at a time. For heavily soiled areas, spray the cleaner directly onto the leather (two squirts should be adequate) and rub with the pad. Repeat if necessary.
- Use a soft, damp cloth to remove the loosened dirt and foam.
- Dry with a soft cloth.

Do not use household cleaners, glass cleaner, alcohol solutions or cleaner intended for vinyl, rubber or plastics. These products can damage the leather.

In some instances, color or dye transfer can occur when wet clothing (wool, denim, leathers or other non-colorfast garments)

Maintenance and care

comes in contact with leather upholstery. If this occurs, the leather should be cleaned immediately to avoid permanent staining.

“Tanners Preserve Leather Cleaner” (product number AS-300) is available from “First Brands” by calling 1-800-726-1001. This product may also be available at many local automotive after market stores.

3M “Type T” Clean And Finish Scrubbing Pads (UPC 04011-01276) are available through your local 3M distributor. Call 1-800-742-9649 for the nearest distributor in your area.

PART NUMBER	PART NAME
(Obtain Locally)	Tanners Preserve Leather Cleaner
(Obtain Locally)	3M "Type T" Clean and Finish Scrubbing Pads

Woodtone trim

Wipe stains with a soft cloth and a multi-purpose cleaning solution.

Inside windows

Use glass cleaner for the inside windows if they become fogged.

Cleaning mirrors

Do not clean your mirrors with a dry cloth or abrasive materials. Use a soft cloth and mild detergent and water. Be careful when removing ice from outside mirrors because you may damage the reflective surface.

Capacities and specifications

MOTORCRAFT PART NUMBERS

Component	4.0L EFI engine	4.0L SOHC engine	5.0L engine
Air filter	FA-1616	FA-1658	FA-1658
Fuel filter	FG-872	FG-872	FG-872
Battery	BXT-65-650	BXT-65-650	BXT-65-650
Oil filter	FL-1A	FL-1A	FL-820S
PCV valve	EV-225	EV-225	EV-152
Spark plugs*	AGRF-22P	AGRF-22P	AWSF-32EE
* Refer to Vehicle Emissions Control Information (VECI) decal for spark plug gap information.			

Capacities and specifications

REFILL CAPACITIES

Fluid	Ford Part Name	Application	Capacity
Engine oil (including filter change)	Motorcraft 5W30 Super Premium Motor Oil	All engines	4.7L (5.0 quarts)
Brake fluid	Ford High Performance DOT 3 Brake Fluid	All	Fill to line in reservoir
Power steering fluid	Motorcraft MERCON® ATF	All	Fill to line on reservoir or dipstick
Transmission fluid	Motorcraft MERCON® ATF	5-speed manual	2.6L (5.6 pints)
	Motorcraft MERCON®V ATF	4R70W Automatic (5.0L engines only)	13.1L (13.9 quarts)
		5R55E Automatic with 4.0L EFI engine (4x2)	9.0L (9.5 quarts)
		5R55E Automatic with 4.0L SOHC engine (4x2)	9.25L (9.75 quarts)
		5R55E Automatic with 4.0L EFI engine (4x4)	9.3L (9.8 quarts)
		5R55E Automatic with 4.0L SOHC engine (4x4)	9.55L (10.0 quarts)
Transfer case	Motorcraft MERCON® ATF	4WD	1.4L (1.5 quarts)
		AWD	1.25L (1.3 quarts)
Engine coolant	Ford Premium Cooling System Fluid	4.0L engine	7.4L (7.8 quarts)
		5.0L engine	12.1L (12.8 quarts)

Capacities and specifications

Fluid	Ford Part Name	Application	Capacity
Front axle fluid	Motorcraft SAE 80W90 Axle Lubricant	All	1.7L (3.5 pints)
Rear axle fluid ^{1, 2, 3, 4}	Motorcraft SAE 80W90 Axle Lubricant	Vehicles with conventional axles	2.9-3.1L (5.50-5.80 pints)
	Motorcraft SAE 75W140 High Performance Synthetic Rear Axle Lubricant	Refer to footnotes 2 and 3	
Windshield washer fluid	Ultra-Clear Windshield Concentrate	All vehicles	2.6L (2.7 quarts)

¹ Fill to 6 mm to 14. 2 (1/4 inch to 9/16 inch) below bottom of fill hole.

² Vehicles equipped with 4.0L SOHC and 4.0L EI engines may have a limited slip differential. If your vehicle is equipped with a limited slip differential, add 118 ml (4 oz.) of additive friction modifier C8AZ-19B546-A, Ford specification EST-M2C118-A, for complete refill of 8.8 inch and 9.75 inch rear axles.

³ Vehicles equipped with 4.0L SOHC or 4.0L EFI engines and 3.73 or 4.10 rear axle ratios or 5.0L engines require synthetic rear axle lubricant. Rear axles containing synthetic lubricant are lubricated for life. These lubricants are not to be checked or changed unless a leak is suspected, service required or the axle assembly has been submerged in water. The axle lubricant should be changed any time the axle has been submerged in water. For Traction-Lok rear axles, add 118 ml (4 oz.) of additive friction modifier C8AZ-19B546-A, Ford specification EST-M2C118-A, whenever the lubricant is changed.

⁴ Refer to your "Service Guide" for axle fluid change intervals.

Capacities and specifications

LUBRICANT SPECIFICATIONS

Fluid	Ford Part Name or equivalent	Ford Part Number	Ford Specification
Windshield washer fluid reservoir	Ford Ultra-Clear Windshield Washer Concentrate	C9AZ-19550-AA OR -BA	ESR-M17P5-A
Body hinges, latches, door stricker plates and rotors, seat tracks, fuel filler door hinge and spring, hood latch, auxiliary latch	Multi-Purpose Grease	D7AZ-19584-AA OR D0AZ-19584-AA	ESR-M1C159-A AND ESB-M1C93-B
Hydraulic clutch master cylinder and brake master cylinder	High Performance DOT 3 Motor Vehicle Brake Fluid	C6AZ-19542-AB	ESZ-M6C25-A
Driveshaft, slip spline, universal joints	Premium Long Life Grease	XG-1-C or K	ESA-M1C75-B
Engine coolant	Ford Premium Cooling System Fluid	E2FZ-19549-AA	ESE-M97B44-A
Engine oil	Motorcraft 5W30 Super Premium Motor Oil	XO-5W30-QSP	WSS-M2C153-G with API Certification Mark
Automatic transmission (4R70W)	Motorcraft MERCON®V ATF	XT-5-QM	MERCON®V
Automatic transmission (5R55E)	Motorcraft MERCON®V ATF	XT-5-QM	MERCON®V

Capacities and specifications

Fluid	Ford Part Name or equivalent	Ford Part Number	Ford Specification
Power steering reservoir	Motorcraft MERCON® ATF	XT-2-QDX	MERCON®
Ford conventional and traction lok rear axles	Refer to footnotes 1, 2 and 3	Refer to footnotes 1, 2 and 3	Refer to footnotes 1, 2 and 3
Front axle	4x4 Gear Oil	F1TZ-19580-A	WSL-M2C191-A
Transfer case - Four wheel drive	Motorcraft MERCON® ATF	XT-2-QDX	MERCON®
5-speed manual transmission	Motorcraft MERCON® ATF	XT-2-QDX	MERCON®
Transfer case Front Output Slip Shaft	Premium Long-Life Grease	XG-1-G or K	ESA-M1C75-B

¹ 4.0L vehicles with conventional and Traction-lok rear axles are filled with Motorcraft SAE 80W90 Premium Rear Axle Lube, part number XY-80W90-QL, Ford specification WSP-M2C197-A.

² 4.0L vehicles with limited slip differentials and all 5.0L applications use rear axles that are filled with Motorcraft SAE 75W140 High Performance Synthetic Rear Axle Lube, part number F1TZ-19580-B, Ford specification WSL-M2C192-A.

³ 4.0L vehicles with limited slip differentials and all 5.0L applications must add 118 ml (4 oz) of additive friction modifier C8AZ-19B546-A, Ford specification EST-M2C118-A to the rear axle whenever the axle has been serviced.

Capacities and specifications

ENGINE DATA

Engine	4.0L EFI engine	4.0L SOHC engine	5.0L engine
Cubic inches	245	245	302
Horsepower	160 @ 4200 rpm	205 @ 5000 rpm	215 @ 4200 rpm
Torque	225 lb. ft. @ 2750 rpm	250 lb. ft. @ 3000 rpm	288 lbs.ft. @ 3300 rpm
Required fuel grade	87 octane	87 octane	87 octane
Firing order	1-4-2-5-3-6	1-4-2-5-3-6	1-3-7-2-6-5-4-8
Spark plug gap	1.3 mm-1.4 mm (0.052-.056 inch)	1.3 mm-1.4 mm (0.052-.056 inch)	1.3 mm-1.4 mm (0.052-.056 inch)
Ignition system	EDIS	EDIS	EDIS
Compression ratio	9.0:1	9.7:1	9.0:1

VEHICLE DIMENSIONS

Dimensions	4 Door mm (in.)	2 Door mm (in.)
(1) Overall length	4 788 (188.5)	4 536 (178.6)
(2) Overall width	1 783 (70.2)	1 783 (70.2)
(3) Maximum height	1 72.5 (67.9)	1 722 (67.8)
(4) Wheelbase	2 835 (111.6)	2 585 (101.8)
(5) Front track / rear	1 486/1 487 (58.5/58.5)	1 486/1 487 (58.5/58.5)

Capacities and specifications

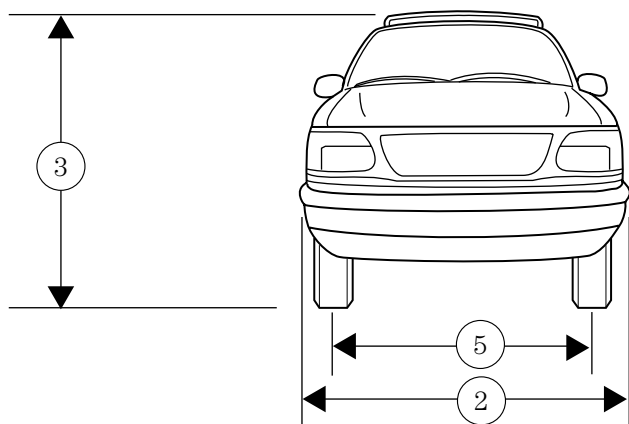
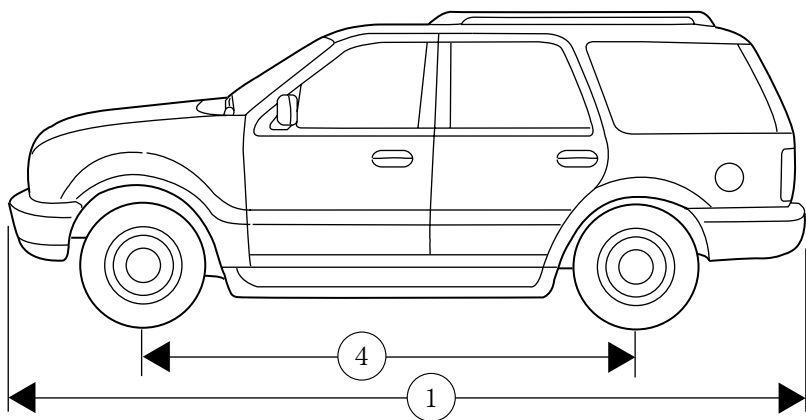

Capacities and specifications

IDENTIFYING YOUR VEHICLE

Safety compliance label

The National Highway Traffic Safety Administration Regulations require that a Safety Compliance Certification Label be affixed to a vehicle and prescribe where the Safety Compliance Certification Label may be located. The Safety Compliance Certification Label is located on the front door latch pillar on the driver's side.

MFD. BY FORD MOTOR CO. IN U.S.A.			
DATE: XXXXX	GVWR: XXXX LB/ XXXXX KG		
FGAWR: XXXXXX/XXXXXX	RGAWR: XXXXXX/XXXXXX		
THIS VEHICLE CONFORMS TO ALL APPLICABLE FEDERAL MOTOR VEHICLE SAFETY STANDARDS IN EFFECT ON THE DATE OF MANUFACTURE SHOWN ABOVE.			
VIN: XXXXXXXXXXXXXXXXX	TYPE: XXXXXXXXXXXXXXXX		
			
MAXIMUM LOAD=OCCUPANTS + LUGGAGE=XXXKG/XXXLB			
OCCUPANTS: X TOTAL X FR X 2ND X RR OCCUPANTS LUGGAGE			
XX XXXKG/XXXLB			
X XXXKG/XXXLB			
TIRE: XXXX/XXXX XXX			
PRESSURE (FR) XXX kPa/33 PSI COLD			
PRESSURE (RR) XXX kPa/33 PSI COLD			
TRAILER TOWING - SEE OWNER GUIDE			
EXT PNT: XXXXXX XXXXXX	RC: XX	DSO: XXXX	F0000
BAR INT TR TP/PS R	AXLE TR SPR	T0000	
X XX XXX X	XX X XXXX		
UTC VFOHT-15294A10-GA			

Vehicle identification number

The vehicle identification number is attached to a metal tag and is located on the driver side instrument panel.



Engine number

The engine number (the last eight numbers of the vehicle identification number) is stamped on the engine block, transmission, frame and transfer case (if so equipped).

Reporting safety defects

REPORTING SAFETY DEFECTS (U.S. ONLY)

If you believe that your vehicle has a defect that could cause a crash, or could cause injury or death, you should immediately inform the National Highway Traffic Safety Administration (NHTSA) in addition to notifying Ford Motor Company.



If NHTSA receives similar complaints, it may open an investigation, and if it finds that a safety defect exists in a group of vehicles, it may order a recall and remedy campaign. However, NHTSA cannot become involved in individual problems between you, your dealer or Ford Motor Company.

To contact NHTSA, you may either call the Auto Safety Hotline toll-free at 1-800-424-9393 (202-366-0123 in the Washington D.C. area) or write to:

NHTSA
U.S. Department of Transportation
400 Seventh Street
Washington D.C. 20590

You can also obtain other information about motor vehicle safety from the Hotline.

Index

- Air bag supplemental restraint system82
- and child safety seats83
- description82
- disposal86
- indicator light85
- passenger air bag84
- Air conditioning
 - manual heating and air conditioning system23,25
- Air suspension
 - description106
- All wheel drive (AWD)121
- Ambulance packages3
- Anti-lock brake system (ABS)
 - description104
- Anti-theft system67
- Autolamp system (see Headlamps)48
- Automatic dimming mirror ...48,49
- Battery175
 - voltage gauge14
- Brake fluid
 - checking and adding164
- Brakes104
 - anti-lock104
 - anti-lock brake system (ABS)
 - warning light104
 - fluid, checking and adding ...164
- Brake-shift interlock107
- Break-in period2
- Bulbs, replacing186
 - headlamps187
 - specifications188
- Cargo cover57
- Changing a tire144
- Child safety seats87
 - built-in child seat91,92,96,97
- Childproof locks52
- Chime
 - headlamps on11
- Cleaning your vehicle191
- built-in child seat195
- engine compartment192
- fabric194
- instrument panel194
- plastic parts194
- safety belts194
- tail lamps194
- washing191
- waxing192
- wheels194
- windows196
- woodtone trim196
- Climate control system
 - automatic temperature control26,27,28,29,30,31,32
- Clutch
 - fluid165
- Compass, electronic45,46
 - calibration48
 - set zone adjustment47
- Console, description54
- Control trac 4WD system116
- Controls53,54
- Cupholder (s)55
- Defrost
 - rear window34
- Driving under special conditions120,122
 - high water120,123
 - slippery roads ...120,121,123,124
- Emission control system185
- Engine202
 - service points158,159,160
- Engine block heater102
- Engine coolant
 - checking and adding166,167
 - disposal168
 - refill capacities168
- Engine oil160,163
 - changing oil and oil filter163
 - checking and adding160,162
- Exhaust fumes103

- Floor mats55
- Foglamps21
- Four-Wheel Drive vehicles
 - control trac34,116
 - special driving instructions118,119
- Fuel
 - calculating fuel economy184
 - improving fuel economy134
 - octane rating183
 - quality184
 - safety information relating to automotive fuels182
- Fuel gauge15
- Fuel pump shut-off switch135
- Fuse panels
 - instrument panel138
 - power distribution box141
- Fuses136,137
- Gauges, Mechanical12
 - engine coolant temperature gauge13
- Hazard flashers135
- Head restraints74
- Headlamps21
 - daytime running lights21
 - flashing22
 - high beam22
- Heating23
- High beams
 - indicator light9
- Hood
 - release lever157
- Ignition
 - positions of the ignition35
- Instrument panel
 - lighting up panel and interior .22
- Jump-starting
 - your vehicle149,151
 - attaching cables149
 - disconnecting cables151
- Keyless entry system
 - autolock63
 - keypad64
 - locking and unlocking doors ...66
 - programming entry code65,66
- Keys
 - key in ignition chime11
- Liftgate55
- Lights, warning and indicator
 - air bag8
 - anti-lock brakes (ABS)8
 - anti-theft9
 - brake8
 - charging system9
 - check engine6,7
 - cruise indicator11
 - door ajar10
 - fuel reset7
 - overdrive off11
 - safety belt8
 - turn signal indicator9
- Load limits
 - trailer towing126
- Lubricant specifications200
- Luggage rack133
- Manual transmission
 - driving113,114,115
- Message center16
 - economy button18
 - english/metric button16,17
 - reset button18
 - system check button19,20
- Mirrors
 - cleaning196
 - heated53
 - side view mirrors (power)52
- Moon roof45
- Motorcraft parts197
- Odometer13
- Off road driving,
 - 4-wheel drive119,122

Index

- Overhead console
 - compass/temperature display ..44
 - storage compartment44
- Panic alarm feature, remote entry system60
- Parking brake105
- Power door locks51
- Power steering
 - fluid, checking and adding169
- Rear window
 - washer42
- Recreational towing, all wheels
 - on the ground133
- Refill capacities for fluids198
- Relays136
- Remote entry system58
 - illuminated entry63
 - locking/unlocking doors59
 - replacement/additional transmitters62,63
 - replacing the batteries62
- Reporting safety defects205
- Safety restraints
 - automatic locking mode (retractor)78,79
 - extension assembly80
 - for children86
 - lap and shoulder belts77,78
 - maintenance81
 - proper use76
 - warning light and chime11, 80,81
- Safety seats for children
 - attaching with tether straps91
 - automatic locking mode (retractor)88
 - tether anchorage hardware91
- Seats72
 - adjusting the seat, power72
 - folding rear seats75
 - lumbar support74
 - rear seat access74
- Servicing your vehicle156
 - precautions when servicing ...156
- Snowplowing3
- Special notice
 - utility-type vehicles3
- Speed control36
 - canceling a set speed39
 - indicator light40
 - resuming a set speed40
 - tap up/tap down38
 - turning off36
- Speedometer12
- Starting your vehicle99,102
- Storage compartments
 - overhead storage compartment44
- Tachometer
 - mechanical cluster14
- Tilt steering wheel41
- Tires177,178
 - checking the pressure178
 - replacing180
 - rotating179
 - snow tires and chains181
 - treadwear177
- Traction-lok rear axle124,175
- Trailer towing126
 - tips132
- Transaxle
 - fluid, checking and adding (manual)173
- Transfer case
 - fluid checking174
- Transmission170
 - automatic operation107,108, 109,110,111,112
 - fluid, checking and adding (automatic)170
- Trip odometer14
- Turn signal
 - lever35
- Vehicle dimensions202

Vehicle headlamp aiming device (VHAD)	189
Vehicle Identification Number (VIN)	204
Vehicle loading	124
Ventilating your vehicle	103
Warning chimes	6
Windows	
power windows, operating	50
Windshield washer fluid and wipers	
checking and adding fluid	166
checking and replacing wiper blades	176
operation	42
Wrecker towing	154

Filling station information

Recommended fuel	Unleaded fuel only - 87 octane
Fuel tank capacity (2 door)	66.2L (17.3 gallons)
Fuel tank capacity (4 door)	79.5L (20.8 gallons)
Engine oil capacity (with filter change)	4.7L (5.0 quarts). Use Motorcraft 5W30 Super Premium Motor Oil, Ford Specification WSS-M2C153-G
Tire size and pressure	See Safety Compliance Certification Label on inside of driver door.
Hood release	Pull handle under the left side of the instrument panel
Coolant capacity-(4.0L engines)	7.4L (7.8 quarts)
Coolant capacity (5.0L engines)	12.1L (12.8 quarts)
Power steering fluid capacity	Fill to line on reservoir or dipstick
Manual transmission fluid capacity	2.6L (2.8 quarts)
Automatic transmission fluid capacity (4R70W transmission) (5.0L engines only)	13.1L (13.9 quarts)
Automatic transmission fluid capacity (4x2 vehicles with 5R55E transmission and 4.0L SOHC engine)	9.25L (9.75 quarts)
Automatic transmission fluid capacity (4x4 vehicles with 5R55E transmission and 4.0L SOHC engine)	9.5L (10.0 quarts)

Ensure correct automatic transmission fluid is used for a specific application. Check the container to verify the fluid is MERCON® and/or MERCON V® approved. Some fluids have been approved as meeting both MERCON® and MERCON® V requirements and will be labeled as such. Fluids labeled as meeting only MERCON® or only MERCON® V requirements must not be used interchangeably. DO NOT mix MERCON® and MERCON® V. Transmission fluid requirements are indicated on the dipstick or on the dipstick handle. Refer to your “Service Guide” to determine the correct service interval.