

## Contents

### Before driving

**Introduction** 2

**Instrumentation** 6

**Controls and features** 22

**Seating and safety restraints** 121

### Starting and driving

**Starting** 152

**Driving** 157

**Roadside emergencies** 185

### Servicing

**Maintenance and care** 207

**Capacities and specifications** 255

**Customer assistance** 263

**Reporting safety defects** 275

**Index** 276

All rights reserved. Reproduction by any means, electronic or mechanical including photocopying, recording or by any information storage and retrieval system or translation in whole or part is not permitted without written authorization from Ford Motor Company. Ford may change the contents without notice and without incurring obligation.

Copyright © 2000 Ford Motor Company

## Introduction

The following warning may be required by California law:

### CALIFORNIA Proposition 65 Warning



**WARNING:** Engine exhaust, some of its constituents, and certain vehicle components contain or emit chemicals known to the State of California to cause cancer and birth defects or other reproductive harm. In addition, certain fluids contained in vehicles and certain products of component wear contain or emit chemicals known to the State of California to cause cancer and birth defects or other reproductive harm.

### ICONS

Indicates a safety alert. Read the following section on *Warnings*.



Indicates vehicle information related to recycling and other environmental concerns will follow.



Correct vehicle usage and the authorized disposal of waste cleaning and lubrication materials are significant steps towards protecting the environment.

Indicates a message regarding child safety restraints. Refer to *Seating and safety restraints* for more information.



Indicates that this Owner Guide contains information on this subject. Please refer to the Index to locate the appropriate section which will provide you more information.



### WARNINGS

Warnings provide information which may reduce the risk of personal injury and prevent possible damage to others, your vehicle and its equipment.

## **BREAKING-IN YOUR VEHICLE**

There are no particular breaking-in rules for your vehicle. During the first 1 600 km (1 000 miles) of driving, vary speeds frequently. This is necessary to give the moving parts a chance to break in.

## **INFORMATION ABOUT THIS GUIDE**

The information found in this guide was in effect at the time of printing. Ford may change the contents without notice and without incurring obligation.

## **SPECIAL NOTICES**

### **Notice to owners of pickup trucks and utility type vehicles**



Utility vehicles have a significantly higher rollover rate than other types of vehicles.

Before you drive your vehicle, please read this Owner's Guide carefully. Your vehicle is not a passenger car. As with other vehicles of this type, failure to operate this vehicle correctly may result in loss of control or an accident.

Be sure to read *Driving off road* in the *Driving* chapter as well as the "Four Wheeling" supplement included with 4WD and utility type vehicles.

### **Using your vehicle with a snowplow**



Do not use this vehicle for snowplowing.

### **Using your vehicle as an ambulance**



Do not use this vehicle as an ambulance.

Your vehicle is not equipped with the Ford Ambulance Preparation Package.

















# Introduction

These are some of the symbols you may see on your vehicle.

## Vehicle Symbol Glossary

Safety Alert		See Owner's Guide	
Fasten Safety Belt		Air Bag-Front	
Air Bag-Side		Child Seat	
Child Seat Installation Warning		Child Seat Tether Anchorage	
Brake System		Anti-Lock Brake System	
Brake Fluid - Non-Petroleum Based		Traction Control	
Master Lighting Switch		Hazard Warning Flasher	
Fog Lamps-Front		Fuse Compartment	
Fuel Pump Reset		Windshield Wash/Wipe	
Windshield Defrost/Demist		Rear Window Defrost/Demist	
Power Windows Front/Rear		Power Window Lockout	

## Vehicle Symbol Glossary

Child Safety Door Lock/Unlock		Interior Luggage Compartment Release Symbol	
Panic Alarm		Engine Oil	
Engine Coolant		Engine Coolant Temperature	
Do Not Open When Hot		Battery	
Avoid Smoking, Flames, or Sparks		Battery Acid	
Explosive Gas		Fan Warning	
Power Steering Fluid		Maintain Correct Fluid Level	
Emission System		Engine Air Filter	
Passenger Compartment Air Filter		Jack	
Check fuel cap			

# Instrumentation

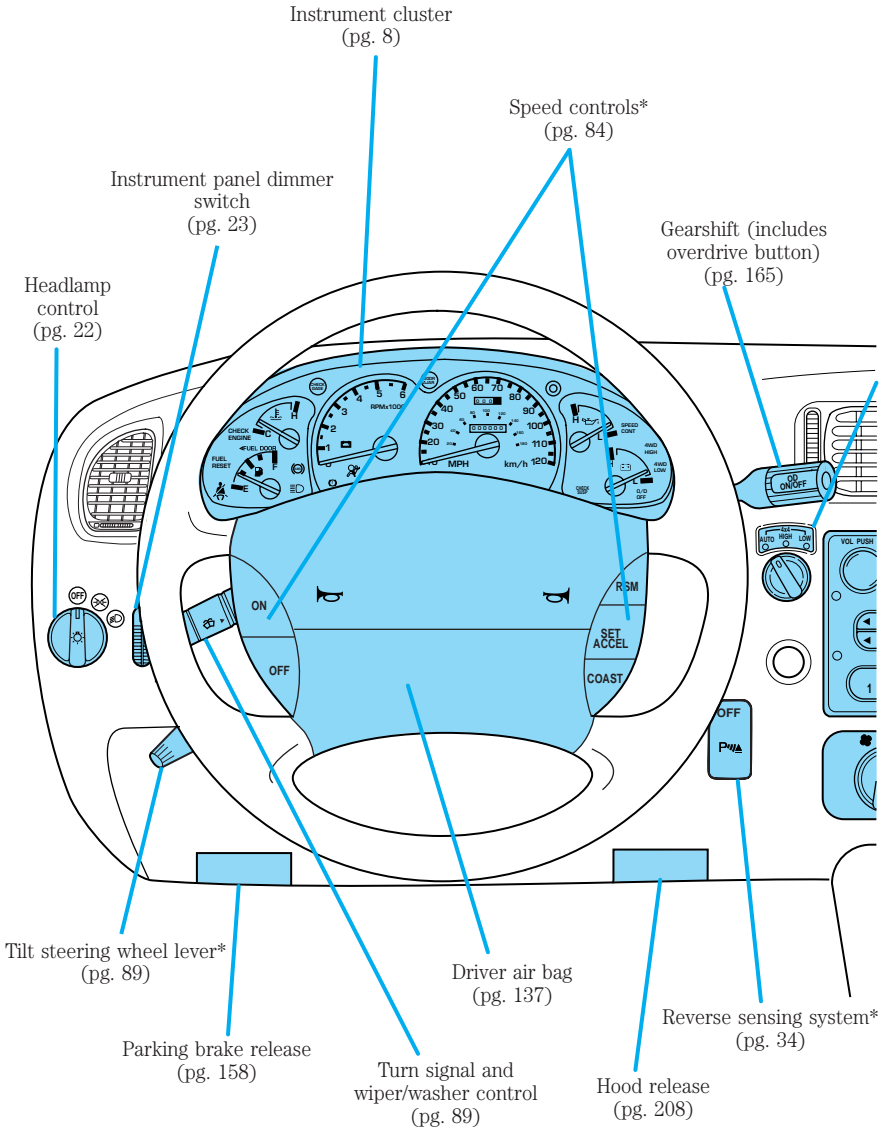

\* if equipped

# Instrumentation

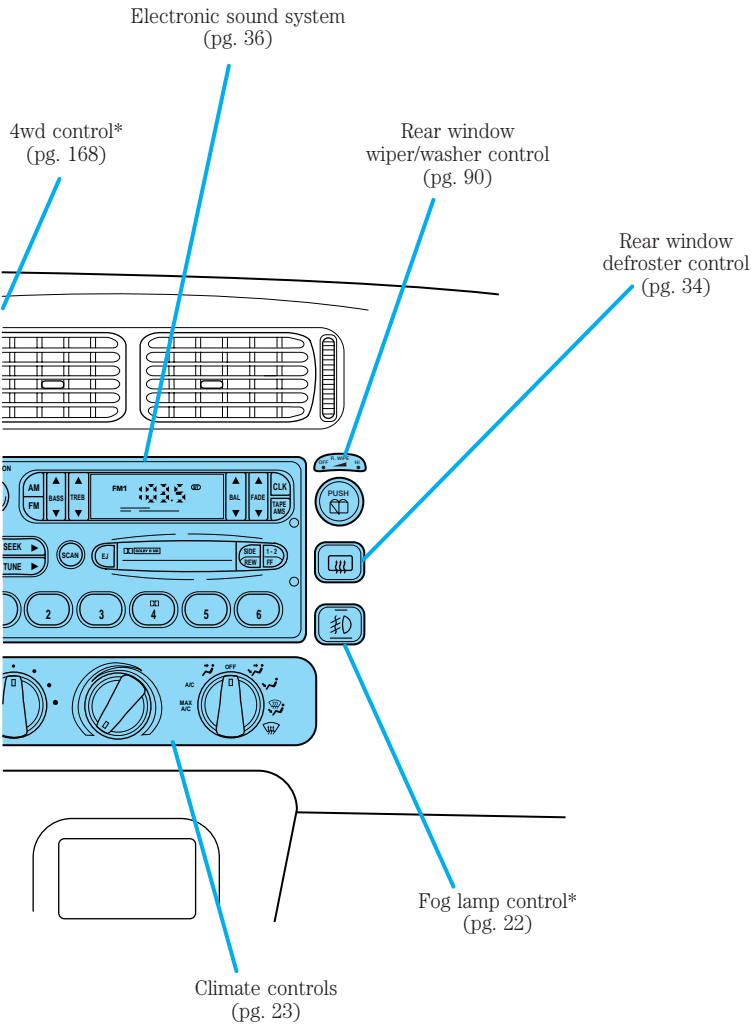

# Instrumentation

## WARNING LIGHTS AND CHIMES

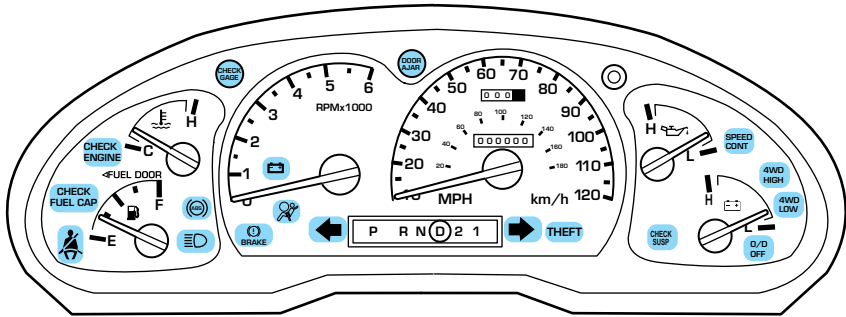

### Check engine

Your vehicle is equipped with a computer that monitors the engine's emission control system. This system is commonly known as the On Board Diagnostics System

(OBD II). This OBD II system protects the environment by ensuring that your vehicle continues to meet government emission standards. The OBD II system also assists the service technician in properly servicing your vehicle.

## CHECK ENGINE

The *Check Engine* indicator light illuminates when the ignition is first turned to the ON position to check the bulb. If it comes on after the engine is started, one of the engine's emission control systems may be malfunctioning. The light may illuminate without a driveability concern being noted. The vehicle will usually be drivable and will not require towing.

### **What you should do if the check engine light illuminates**

#### **Light turns on solid:**

This means that the OBD II system has detected a malfunction.

Temporary malfunctions may cause your *Check Engine* light to illuminate. Examples are:

1. The vehicle has run out of fuel. (The engine may misfire or run poorly.)
2. Poor fuel quality or water in the fuel.



## Instrumentation

3. The fuel cap may not have been properly installed and securely tightened.

These temporary malfunctions can be corrected by filling the fuel tank with high quality fuel of the recommended octane and/or properly installing and securely tightening the gas cap. After three driving cycles without these or any other temporary malfunctions present, the *Check Engine* light should turn off. (A driving cycle consists of a cold engine startup followed by mixed city/highway driving.) No additional vehicle service is required.

If the *Check Engine* light remains on, have your vehicle serviced at the first available opportunity.

### **Light is blinking:**

Engine misfire is occurring which could damage your catalytic converter. You should drive in a moderate fashion (avoid heavy acceleration and deceleration) and have your vehicle serviced at the first available opportunity.



Under engine misfire conditions, excessive exhaust temperatures could damage the catalytic converter, the fuel system, interior floor coverings or other vehicle components, possibly causing a fire.

### **Check fuel cap**

Momentarily illuminates when the ignition is turned to the ON position to ensure your bulb is working.

When this light turns on, check the fuel filler cap. Continuing to operate the vehicle with the check fuel cap light on, can activate the *Service Engine Soon/Check Engine* warning light. When the fuel filler cap is properly re-installed, the light(s) will turn off after a period of normal driving. This period will vary depending on driving conditions.

**It may take a long period of time for the system to detect an improperly installed fuel filler cap.**

For more information, refer to *Fuel filler cap* in the *Maintenance and care* chapter.

**CHECK  
FUEL CAP**

## Instrumentation

### Air bag readiness

Momentarily illuminates when the ignition is turned ON. If the light fails to illuminate, continues to flash or remains on, have the system serviced immediately.



### Safety belt

Momentarily illuminates when the ignition is turned to the ON position to remind you to fasten your safety belts. For more information, refer to the *Seating and safety restraints* chapter.



### Brake system warning

Momentarily illuminates when the ignition is turned to the ON position to ensure the circuit is functional. Also illuminates if the parking brake is engaged. If the brake warning lamp does not illuminate at these times, seek service immediately. Illumination after releasing the parking brake indicates low brake fluid level and the brake system should be inspected immediately.



### Anti-lock brake system (ABS)

Momentarily illuminates when the ignition is turned to the ON position to ensure the circuit is functional. If the light remains on, continues to flash or fails to illuminate, have the system serviced immediately. With the ABS light on, the anti-lock brake system is disabled and normal braking is still effective unless the brake warning light also remains illuminated with the parking brake released.



## Instrumentation

### Turn signal

Illuminates when the left or right turn signal or the hazard lights are turned on. If one or both of the indicators stay on continuously or flash faster, check for a burned-out turn signal bulb. Refer to *Bulbs* in the *Maintenance and care* chapter.

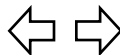

### High beams

Illuminates when the high beam headlamps are turned on.



### Anti-theft system (if equipped)

Refer to *SecuriLock<sup>™</sup> passive anti-theft system* in the *Controls and features* chapter.



### Charging system

Illuminates when the ignition is turned to the ON position and the engine is off. The light also illuminates when the battery is not charging properly, requiring electrical system service.

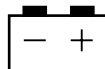

### Check gage

Illuminates when the engine coolant temperature is high, the engine oil pressure is low or the fuel gauge is at or near empty. The ignition must

be in the ON position for this lamp to illuminate. The lamp will also stay illuminated after the ignition is turned to the ON position. Refer to *Engine coolant temperature gauge*, *Engine oil pressure gauge* or *Fuel gauge* in this chapter for more information.



## Instrumentation

### Four wheel drive low (if equipped)

Momentarily illuminates when the ignition is turned to the ON/START position. Illuminates when four-wheel drive low is engaged. If the light continues to flash have the system serviced.

**4WD  
LOW**

### Four wheel drive high (if equipped)

Momentarily illuminates when the ignition is turned to the START position. Illuminates when four-wheel drive high is engaged. If the light continues to flash have the system serviced.

**4WD  
HIGH**

### Door ajar

Illuminates when the ignition is in the ON or START position and any door is open.

**DOOR  
AJAR**

### O/D off (if equipped)

Illuminates when the Transmission Control Switch (TCS), refer to *Overdrive control* in the *Controls and Features* chapter, has been pushed turning the transmission overdrive function OFF. When the light is on, the transmission does not operate in the overdrive mode, refer to the *Driving* chapter for transmission function and operation.

**O/D  
OFF**

The light may also flash steadily if a transmission malfunction is detected. If the light does not come on when the Transmission Control Switch is depressed or if the light flashes steadily, have your vehicle serviced as soon as possible, damage to the transmission could occur.

### Check air suspension (if equipped)

Illuminates momentarily when the ignition is turned to the ON position and the engine is OFF. The light also illuminates when the air suspension system requires servicing.

**CHECK  
SUSP**

For information, refer to *Air suspension system* in the *Driving* chapter.

## Speed control

This light comes on when either the SET/ACCEL or RESUME controls are pressed. It turns off when the speed control OFF control is pressed, the brake or clutch (if equipped) is applied or the ignition is turned to the OFF position.

# SPEED CONT

## Safety belt warning chime

Sounds to remind you to fasten your safety belts.

For information on the safety belt warning chime, refer to the *Seating and safety restraints* chapter.

## Supplemental restraint system (SRS) warning chime

For information on the SRS warning chime, refer to the *Seating and safety restraints* chapter.

## Key-in-ignition warning chime

Sounds when the key is left in the ignition in the OFF/LOCK or ACC position and the driver's door is opened.

## Headlamps on warning chime

Sounds when the headlamps or parking lamps are on, the ignition is off (and the key is not in the ignition) and the driver's door is opened.

## GAUGES

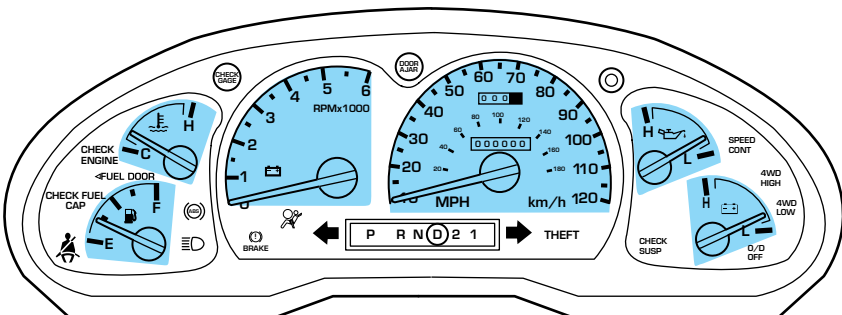

## Instrumentation

### Speedometer

Indicates the current vehicle speed.

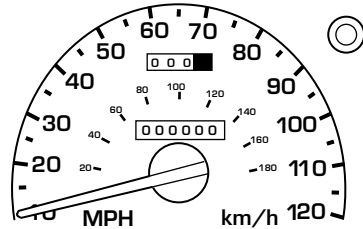

### Engine coolant temperature gauge

Indicates the temperature of the engine coolant. At normal operating temperature, the needle remains within the normal area (the area between the “H” and “C”). If it enters the red section, the engine is overheating. Stop the vehicle as soon as safely possible, switch off the engine immediately and let the engine cool. Refer to *Engine coolant* in the *Maintenance and care* chapter.

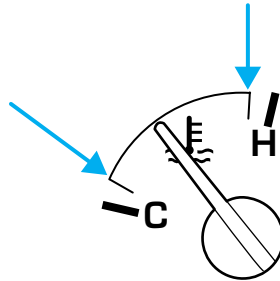

Never remove the coolant reservoir cap while the engine is running or hot.

This gauge indicates the temperature of the engine coolant, not the coolant level. If the coolant is not at its proper level the gauge indication will not be accurate.

# Instrumentation

## Odometer

Registers the total kilometers (miles) of the vehicle.

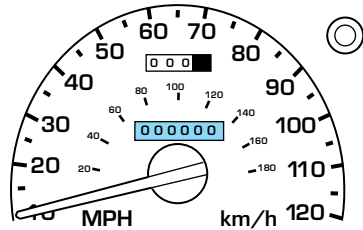

## Trip odometer

Registers the kilometers (miles) of individual journeys. To reset, depress the control.

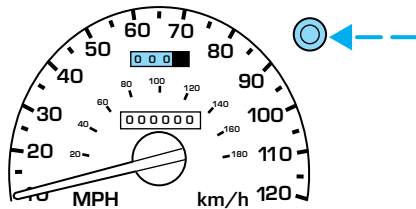

## Tachometer

Indicates the engine speed in revolutions per minute.

Driving with your tachometer pointer continuously at the top of the scale may damage the engine.

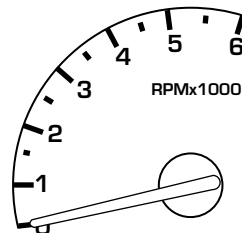

## Instrumentation

### Battery voltage gauge

This shows the battery voltage when the ignition is in the ON position. If the pointer moves and stays outside the normal operating range (as indicated by arrows), have the vehicle's electrical system checked as soon as possible.

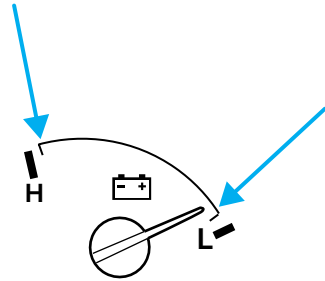

### Engine oil pressure gauge

This shows the engine oil pressure in the system. Sufficient pressure exists as long as the needle remains in the normal range (the area between the "L" and "H").

If the gauge indicates low pressure, stop the vehicle as soon as safely possible and switch off the engine immediately. Check the oil level.

Add oil if needed (refer to *Engine oil* in the *Maintenance and care*

chapter). If the oil level is correct, have your vehicle checked at your dealership or by a qualified technician.

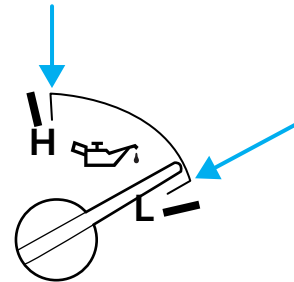

### Fuel gauge

Displays approximately how much fuel is in the fuel tank (when the key is in the ON position). The fuel gauge may vary slightly when the vehicle is in motion. The ignition should be in the OFF position while the vehicle is being refueled. When the gauge first indicates empty, there is a small amount of reserve fuel in the tank. When refueling the vehicle from empty indication, the

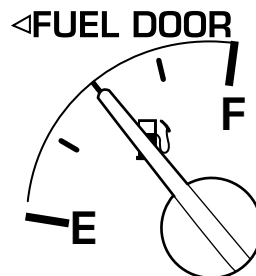



## Instrumentation

amount of fuel that can be added will be less than the advertised capacity due to the reserve fuel.

The FUEL DOOR icon and arrow indicates which side of the vehicle the fuel filler door is located.

### MESSAGE CENTER (IF EQUIPPED)

With the ignition in the ON position, the message center displays important vehicle information through a constant monitor of vehicle systems. You may select display features on the message center for a display of status preceded by a brief indicator chime. The system will also notify you of potential vehicle problems with a display of system warnings.

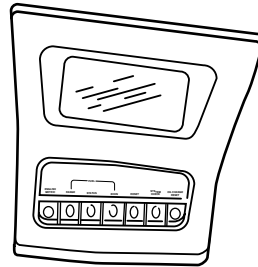

### Selectable features

#### *English/metric display*

Press to toggle the message center display between metric or English units.

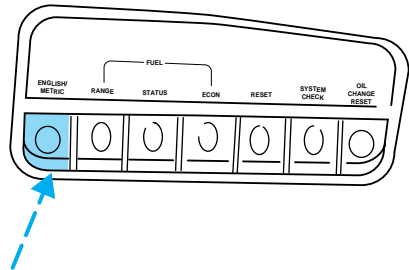

## Instrumentation

### **Fuel range**

Press once to display the approximate kilometers (miles) left to drive before the fuel tank is empty.

Press again to display the distance driven since this function was last manually reset.

For maximum accuracy of this display feature, the ignition should be in the OFF position during fueling. The display FUEL LEVEL ERROR indicates a problem with the fuel indication system. See your dealer or qualified service technician for system maintenance.

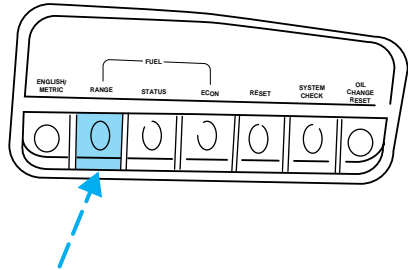

### **Fuel status**

Press once to display the approximate amount of fuel remaining in the fuel tank.

Press again to display the approximate amount of fuel used since the system was last reset.

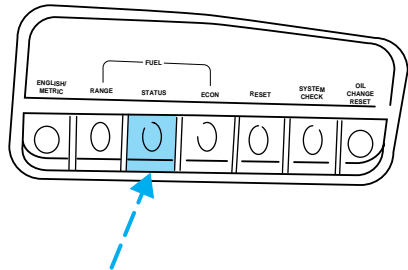

### **Fuel economy**

Press to display your vehicle's average fuel economy in liters/100 km or (miles/gallons).

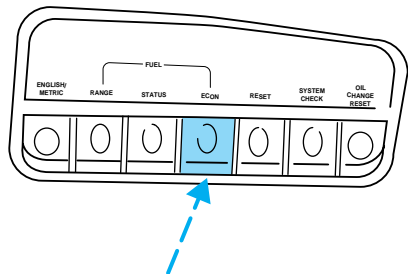

## Instrumentation

### Reset

Press the reset control to reset the current feature being displayed. Warnings, distance driven, average fuel economy, fuel used and personalized oil reset percentage are the only features that respond to reset.

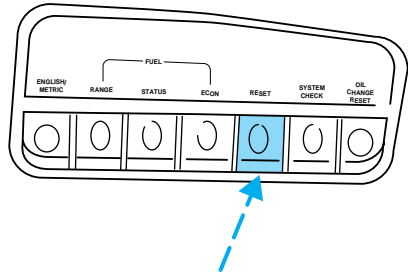

### System check

Press the system check control to display the status of the following systems:

- engine oil life left
- engine oil level
- voltage level
- engine coolant temperature
- washer fluid level
- fuel level

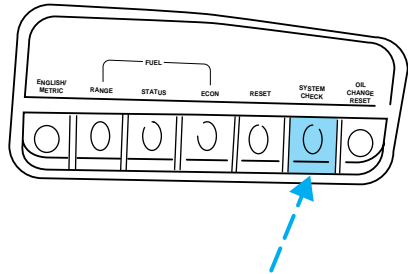

The engine oil life left has two phases. The first display will indicate the oil change status (OK, SOON, REQUIRED). The second display will indicate the percentage of oil life remaining. The display OIL TEMP SIGNAL ERROR indicates a problem with the system. Following this display, contact your dealer or qualified service technician for system maintenance.

### Operating the message center during system check

The message center controls can be operated as follows during the system check sequence:

1. Press the system check controls to advance to the next display.
2. Press the reset control to immediately conclude the system check.
3. Press the range, fuel status or fuel economy control to conclude the system check and display the requested feature.

## Instrumentation

4. Press the metric/English control to conclude the system check and change the previous display to the new mode.
5. Press the oil change reset control to conclude the system check and begin the oil change reset procedure.

An oil change is recommended whenever indicated by the message center. Use only recommended engine oils.

The message center will tell you the percent of oil life left during system check. This percentage is based on your driving history and the time since your last oil change. In order to ensure accurate oil life left indications, you should only perform the following procedure after you have the oil changed.

### ***Oil change reset***

Press the OIL CHANGE RESET control to reset the oil life feature to 100% (or your personalized oil reset percentage) (at optimal driving conditions, 100% oil life is equivalent to a maximum of 12 000 kilometers [7 500 miles]). After you have the oil changed, you must press and hold the OIL CHANGE RESET control for five seconds. The message center will count down for five seconds. After a successful reset, the message center will display OIL LIFE RESET TO 100%. (If you have established a personalized oil reset percentage, the display will show that percentage instead of 100%.) This reset procedure should be performed only after an oil change to ensure accurate oil life indications.

Your personalized oil reset percentage allows you to establish a smaller oil change interval than the manufacturer's recommended interval. To establish your personalized oil reset percentage:

1. Press and hold the OIL CHANGE RESET control and press the RESET control while the display is still counting down the five seconds to reset. The display will change to START OIL LIFE AT XXX%.
2. Press the OIL CHANGE RESET control until the displayed percentage is the personalized oil reset percentage you desire. Your choices are 100%, 90%, 80%, 70%, 60%, 50%, 40% and 30%.

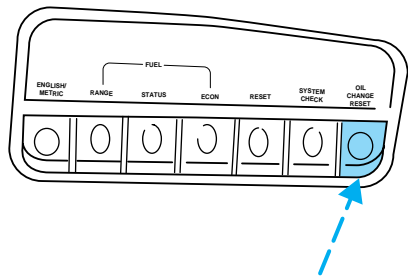

## Instrumentation

3. Press the RESET control to complete the procedure. Pressing any control other than RESET or OIL CHANGE RESET will abort this procedure and will not establish your new personalized oil reset percentage.

When your personalized oil reset percentage has been established, it will be used beginning with the completion of your next OIL CHANGE RESET procedure.

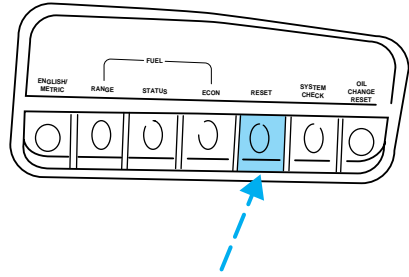

## Controls and features

### HEADLAMP CONTROL ☀️

Rotate the headlamp control to the first position to turn on the parking lamps. Rotate to the second position to also turn on the headlamps.

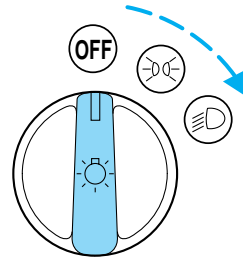

### Foglamp control (if equipped) ☘️

Turn on the low-beam headlamps or parking lamps and press the foglamp control to activate the foglamps. The foglamp control will illuminate when the foglamps are on.

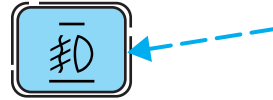

Press the foglamp control a second time to deactivate the foglamps.

### Daytime running lamps (DRL) (if equipped)

Turns the headlamps on with a reduced output. To activate:

- the ignition must be in the ON position and
- the headlamp control is in the OFF or Parking lamps position.



Always remember to turn on your headlamps at dusk or during inclement weather. The Daytime Running Light (DRL) System does not activate your tail lamps and generally may not provide adequate lighting during these conditions. Failure to activate your headlamps under these conditions may result in a collision.

### High beams ≡

Push forward to activate.

Pull toward you to deactivate.

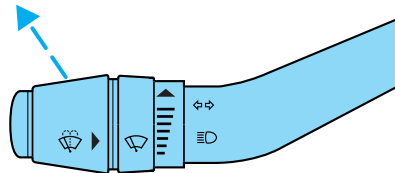

## Controls and features

### Flash to pass

Pull toward you to activate and release to deactivate.

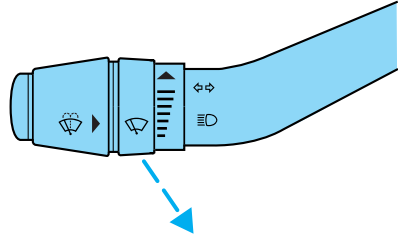

### PANEL DIMMER CONTROL

Use to adjust the brightness of the instrument panel during headlamp and parklamp operation.

- Rotate up to brighten.
- Rotate down to dim.
- Rotate to full up position (past detent) to turn on interior lamps.

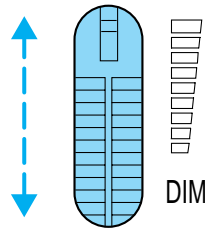

### CLIMATE CONTROL SYSTEM

#### Manual heating and air conditioning system (if equipped)

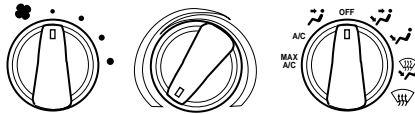

#### Fan speed control

Controls the volume of air circulated in the vehicle.



## Controls and features

### Temperature control knob

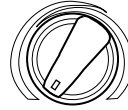

Controls the temperature of the airflow inside the vehicle.



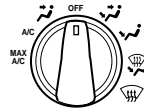

### Mode selector control

Controls the direction of the airflow to the inside of the vehicle.



The air conditioning compressor can operate in all modes except  and . However, the air conditioning will only function if the outside temperature is about 6°C (43°F) or higher.



Since the air conditioner removes considerable moisture from the air during operation, it is normal if clear water drips on the ground under the air conditioner drain while the system is working and even after you have stopped the vehicle.

- **MAX A/C**-Uses recirculated air to cool the vehicle. MAX A/C is noisier than A/C but more economical and will cool the inside of the vehicle faster. Airflow will be from the instrument panel registers. This mode can also be used to prevent undesirable odors from entering the vehicle. When placed in MAX A/C, the air conditioning will operate at a full cool temperature. Therefore, the temperature control becomes non-functional.
- **A/C**-Uses outside air to cool the vehicle. It is quieter than MAX A/C but not as economical. Airflow will be from the instrument panel registers.
-  (Panel)-Distributes outside air through the instrument panel registers. However, the air will not be cooled below the outside temperature because the air conditioning does not operate in this mode.
- **OFF**-Outside air is shut out and the fan will not operate. For short periods of time only, use this mode to prevent undesirable odors from entering the vehicle.
-  (Panel and floor)-Distributes outside air through the instrument panel registers and the floor ducts. Heating and air conditioning



## Controls and features

capabilities are provided in this mode. For added customer comfort, when the temperature control knob is anywhere in between the full hot and full cold positions, the air distributed through the floor ducts will be slightly warmer than the air sent to the instrument panel registers.

-  (Floor)-Allows for maximum heating by distributing outside air through the floor ducts. However, the air will not be cooled below the outside temperature because the air conditioning does not operate in this mode.
-  (Floor and defrost)-Distributes outside air through the windshield defroster ducts and the floor ducts. Heating and air conditioning capabilities are provided in this mode. For added customer comfort, when the temperature control knob is anywhere in between the full hot and full cold positions, the air distributed through the floor ducts will be slightly warmer than the air sent to the windshield defrost ducts. If the temperature is about 6°C (43°F) or higher, the air conditioner will automatically dehumidify the air to reduce fogging.
-  (Defrost)-Distributes outside air through the windshield defroster ducts. It can be used to clear ice or fog from the windshield. If the temperature is about 6°C (43°F) or higher, the air conditioner will automatically dehumidify the air to reduce fogging.

### **Operating tips**

- In humid weather conditions, place the climate control system in  before driving. This will reduce fogging on your windshield. Once the windshield has been cleared, operate the climate control system as desired.
- To reduce humidity buildup inside the vehicle in cold weather conditions, don't drive with the climate control system in the OFF or MAX A/C position.
- To reduce humidity buildup inside the vehicle in warm weather conditions, don't drive with the climate control system in the OFF position.
- Under normal weather conditions, your vehicle's climate control system should be left in any position other than MAX A/C or OFF when the vehicle is parked. This allows the vehicle to "breathe" through the outside air inlet duct.

## Controls and features

- Under snowy or dirty weather conditions, your vehicle's climate control system should be left in the OFF position when the vehicle is parked. This allows the climate control system to be free from contamination of outside pollutants.
- If your vehicle has been parked with the windows closed during warm weather conditions, the air conditioner will perform more efficiently in cooling the vehicle if driven for two or three minutes with the windows open. This will force most of the hot, stale air out of the vehicle. Once the vehicle has been "aired out", operate the climate control system as desired.
- Do not place objects under the front seat that will interfere with the airflow to the back seats (if equipped).
- Remove any snow, ice or leaves from the air intake area at the base of the windshield.

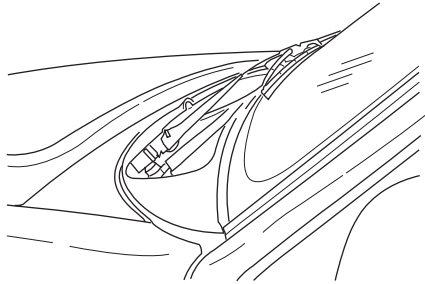

- Do not place objects over the defroster outlets. These objects can block airflow and reduce your ability to see through your windshield. Avoid placing small objects on top of the instrument panel. These objects may fall down into the defroster outlets and block airflow, in addition to damaging the climate control system.

To aid in side window defogging/demisting in cold weather conditions:

1. Select 
2. Set the temperature control to full heat
3. Set the fan speed to HI
4. Direct the outer panel vents towards to side windows

To increase airflow to the outer panel vents, close the central panel vents.



Do not place objects on top of the instrument panel, as these objects may become projectiles in a collision or sudden stop.

## Controls and features

### Electronic Automatic Temperature Control (EATC) system (if equipped)

The EATC system will maintain a selected temperature and automatically control airflow. You can override automatic operation with any of the override controls, the fan speed control or the steering wheel controls.

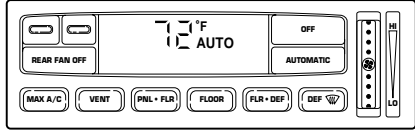

#### Turning the EATC on

Press **AUTOMATIC**, any of the override controls or the fan speed control. The EATC will only operate when the vehicle is running.

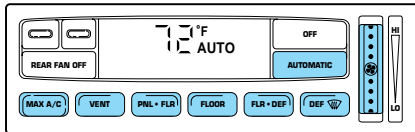

#### Turning the EATC off

Press **OFF**.

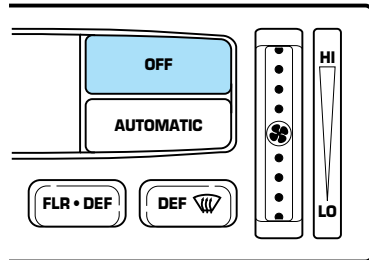

#### Automatic operation

Press **AUTOMATIC** and select the desired temperature. The selected temperature and the word **AUTO** will appear in the display window. The EATC system will either heat or cool to achieve the selected temperature. The system will automatically determine fan speed, airflow location and if outside air or recirculated air is required. Fan speed remains automatic unless the fan speed thumbwheel is turned or the steering wheel fan speed control is pressed.

When in **AUTOMATIC** and weather conditions require heat, air will be sent to the floor. However, if the engine is not warm enough to provide heat, the fan will be at a low speed and the air will be directed to the

## Controls and features

windshield. In 3½ minutes or less, the fan speed will start to increase and the airflow location will change to the floor area.

If unusual conditions exist (i.e.-window fogging, etc.), the manual override controls allow you to select airflow locations and the fan control allows you to adjust fan speed as necessary.

### Temperature selection

The display window indicates the selected temperature, function (AUTO or one of the override controls) and manual control of fan speed (☼) if automatic fan speed is not desired.

To control the temperature, select any temperature between 18°C (65°F) and 29°C (85°F) by pressing the blue (cooler) or red (warmer) buttons.

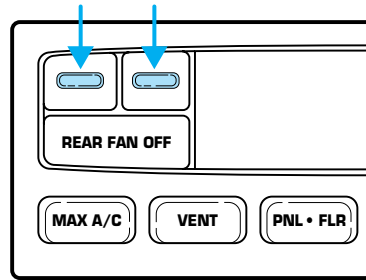

For continuous maximum cooling, push the blue button until 16°C (60°F) is shown in the display window. The EATC will continue maximum cooling (disregarding the displayed temperature) until a warmer temperature is selected by pressing the red button.

For continuous maximum heating, push the red button until 32°C (90°F) is shown in the display window. The EATC will continue maximum heating (disregarding the displayed temperature) until a cooler temperature is selected by pressing the blue button.

### Temperature conversion

Press MAX A/C and DEF  at the same time (for one second) to switch between Fahrenheit and Celsius.

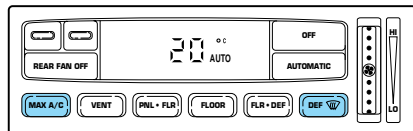

If your vehicle has an English/Metric (E/M) control, this control will also change the temperature display.

## Controls and features

### Fan speed ( )

When AUTOMATIC is pressed, fan speed is adjusted automatically for existing conditions. You can override fan speed at any time. To control fan speed manually, use the thumbwheel or steering wheel control to cancel automatic fan speed operation.

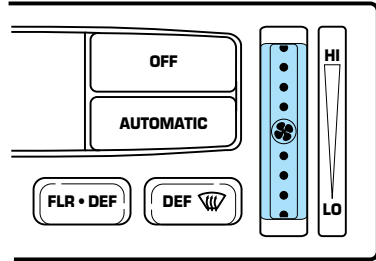

- Rotate the thumbwheel up for higher fan speed or down for lower fan speed.
- Press the steering wheel fan speed control up for higher fan speed or down for lower fan speed.

The display will show  to indicate manual fan operation.



To return to automatic fan operation, press AUTOMATIC.

### Manual override controls

The override controls are located at the bottom of the EATC and allow you to determine where airflow is directed. To return to full automatic control, press AUTOMATIC.

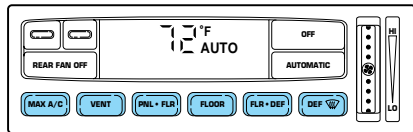

The air conditioning compressor will operate in all modes except FLOOR and VENT. It will also operate only when required when AUTOMATIC has been selected. However, the air conditioning will only function if the outside temperature is about 6°C (43°F) or higher.

Since the air conditioner removes considerable moisture from the air during operation, it is normal if clear water drips on the ground under the air conditioner drain while the system is working and even after you have stopped the vehicle.

## Controls and features

- **MAX A/C**-Uses recirculated air to cool the vehicle. The temperature will display 16°C (60°F). To exit, press **AUTOMATIC** or any other override controls. **MAX A/C** is noisier than normal **A/C** but more economical and will cool the inside of the vehicle faster. Airflow is from the instrument panel registers. This mode can also be used to prevent undesirable odors from entering the vehicle.
- **VENT**-Distributes outside air through the instrument panel registers. However, the air cannot be cooled below the outside temperature because the air conditioning does not operate in this mode.
- **PNL•FLR**-Distributes outside air through the instrument panel registers and the floor ducts. Heating and air conditioning capabilities are provided in this mode. The air will be heated or cooled based on the temperature selection. For added customer comfort, the air distributed through the floor ducts will be slightly warmer than the air sent to the instrument panel registers.
- **FLOOR**-Allows for maximum heating by distributing outside air through the floor ducts. However, the air cannot be cooled below the outside temperature because the air conditioning does not operate in this mode.
- **FLR•DEF**-Distributes outside air through the windshield defroster ducts and the floor ducts. Heating and air conditioning capabilities are provided in this mode. The air will be heated or cooled based on the temperature selection. For added customer comfort, the air distributed through the floor ducts will be slightly warmer than the air sent to the windshield defroster ducts. If the temperature is about 6°C (43°F) or higher, the air conditioner will automatically dehumidify the air to reduce fogging.
- **DEF**  -Distributes outside air through the windshield defroster ducts. It can be used to clear ice or fog from the windshield. If the outside air temperature is about 6°C (43°F) or higher, the air conditioner will automatically dehumidify the air to reduce fogging.
- **OFF**-Outside air is shut out and the fan will not operate. For short periods of time only, use this mode to reduce undesirable odors from entering the vehicle.

## Controls and features

### **Rear fan off**

Press REAR FAN OFF to turn off the rear console fan. This overrides the rear console fan speed control.

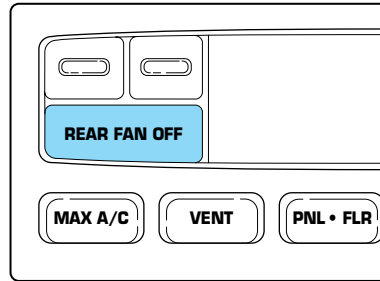

The EATC display window will indicate REAR FAN OFF.

The rear console fan will remain off until REAR FAN OFF is pressed again.

To aid in defogging and demisting (removing condensation on the inside of the windshield) in cool weather:

1. Select PANEL & FLOOR
2. Set the temperature control to full heat
3. Select A/C
4. Set the fan speed to HI
5. Direct the outer panel vents towards to side windows

To increase airflow to the outer panel vents, close the central panel vents.

### **Operating tips**

- In humid weather, select DEF  before driving. This will reduce fogging on your windshield. After a few minutes, select any desired position.
- To reduce humidity buildup inside the vehicle, don't drive with the climate control system in the OFF position.
- Don't put objects under the front seat that will interfere with the airflow to the rear seats.

## Controls and features

- Remove any snow, ice or leaves from the air intake area at the base of the windshield.

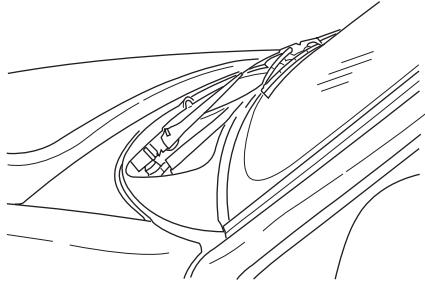

- If your vehicle has been parked with the windows closed during hot weather, the air conditioner will do a much faster job of cooling if you drive for two or three minutes with the windows open. This will force most of the hot, stale air out of the vehicle. Then operate the air conditioner as you would normally.
- Do not place objects over the defroster outlets. These objects can block airflow and reduce your ability to see through your windshield. Also, avoid placing small objects on top of your instrument panel. These objects can fall down into the defroster outlets and block airflow and possibly damage your climate control system.



Do not place objects on top of the instrument panel, as these objects may become projectiles in a collision or sudden stop.

### Rear console climate controls (if equipped)

Depending on the equipment package of your vehicle, the rear console may be equipped with rear console audio/climate controls.

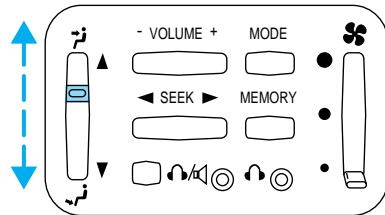

The instrument panel climate controls must be on in order for the rear console climate controls to work.

Turn the air distribution control to the desired airflow position.



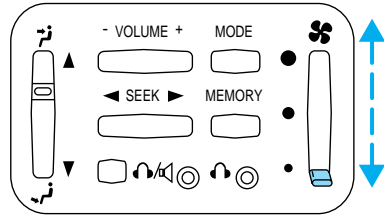

## Controls and features

Turn the fan speed control to the desired position.

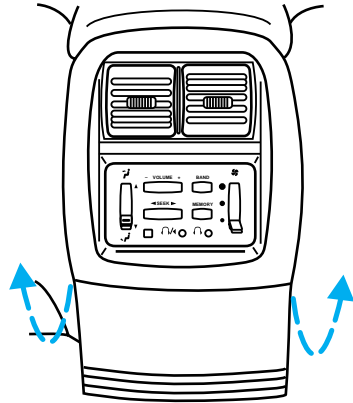

Select  for air to flow through these vents:



Select  for air to flow through these vents:

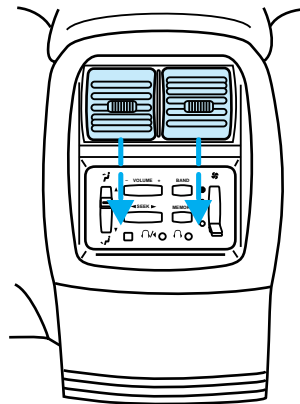

## Controls and features

### REAR WINDOW DEFROSTER

The rear defroster control is located on the instrument panel.

Press the rear defroster control to clear the rear window of thin ice and fog.

- A small LED will illuminate when the rear defroster is activated.

The ignition must be in the ON position to operate the rear window defroster.

The defroster turns off automatically after 10 minutes or when the ignition is turned to the OFF position. To manually turn off the defroster before 10 minutes have passed, push the control again.

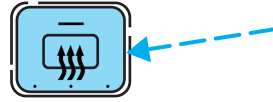

### 4WD CONTROL (IF EQUIPPED)

This control operates the 4WD. Refer to the *Driving* chapter for more information.

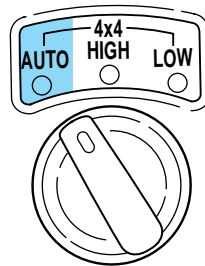

### REVERSE SENSING SYSTEM (IF EQUIPPED)

The reverse sensing system (RSS) sounds a tone to warn the driver of obstacles near the rear bumper when the reverse gear is selected.



To help avoid personal injury, please read and understand the limitations on the reverse sensing system described below.

Reverse sensing is only an assist for some (generally large and fixed) objects when moving in reverse on a flat surface at “parking speeds” of approximately 6 km/h (4 mph) or less. The weather may also affect the function of RSS. RSS may have reduced performance, or be activated in inclement weather. It is the driver’s responsibility for ensuring that their path is clear when operating the vehicle.

## Controls and features



To help avoid personal injury, always use caution when in reverse and when using the reverse sensing system.



This system is not designed to prevent contact with small or moving objects. The system is designed to provide a warning to assist the driver in detecting large stationary objects to avoid damaging the vehicle. The system may not detect smaller objects, particularly those close to the ground.

The RSS will assist the driver in detecting certain objects while the vehicle slowly moves in reverse at speeds less than 6 km/h (4 mph). The RSS is not effective at speeds greater than 6 km/h (4 mph) and may not detect certain angular or moving objects.

The reverse sensing system detects obstacles within approximately 1.8 meters (5.9 ft.) of the rear bumper with a decreased coverage area at the outer corners of the bumper, (refer to the figures for approximate zone coverage areas). As you move closer to the obstacle, the rate of the tone increases. When the distance to the obstacle is less than 25.0 cm (10 in.), the tone will sound continuously. If the system detects a stationary or receding object further than 25.0 cm (10 in.) from the side of the vehicle, the tone will sound for only three seconds. Once the system detects an object approaching, the tone will sound again.

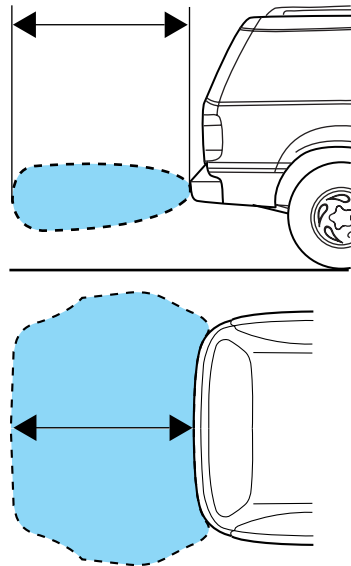

## Controls and features

The reverse sensing system is automatically enabled when the gear selector is placed in R (Reverse) and the ignition is ON. A reverse sensing control allows the driver to disable the reverse sensing system only when the ignition is ON, and the gear selector is in R (Reverse).



The OFF indicator remains illuminated when the system is disabled. The system defaults to ON every time the reverse gear is selected. Press the control to disable or enable the system.

The indicator will remain illuminated to indicate a failure of the reverse sensing system.

**Always keep the sensors (located on the rear bumper/fascia) free from dirt, snow and ice (do not clean the sensors with sharp objects). These elements may cause the system to operate inaccurately.**

**If the vehicle sustains damage to the rear bumper/fascia, leaving it misaligned or bent, the sensing zone may be altered causing inaccurate measurement of obstacles or false alarms.**

## USING YOUR AUDIO SYSTEM

### AM/FM stereo cassette

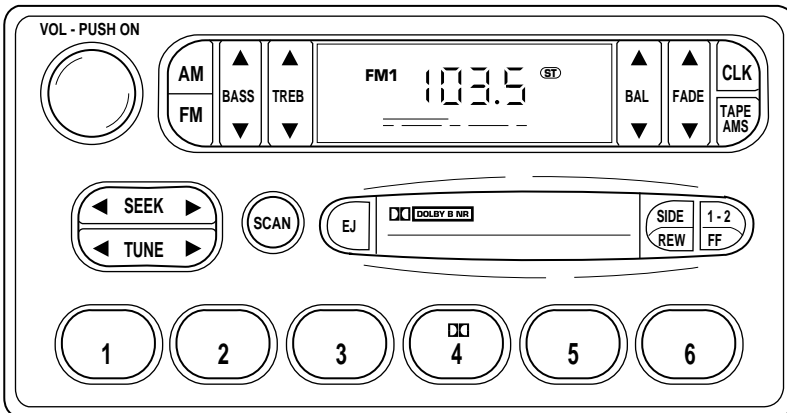

## Controls and features

### ***Volume/power control***

Press the control to turn the audio system on or off.



Turn the control to raise or lower volume.



If the volume is set above a certain level and the ignition is turned off, the volume will come back on at a “nominal” listening level when the ignition switch is turned back on.

### ***AM/FM select***

The AM/FM select control works in radio and tape modes.

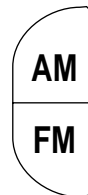

### ***AM/FM select in radio mode***

This control allows you to select AM or FM frequency bands. Press the AM control to select from AM selections, and press the FM control to select from FM1 or FM2 memory preset stations.

### ***AM/FM select in tape mode***

Press this control to stop tape play and begin radio play.

## Controls and features

### ***Tune adjust***

The tune control works in radio mode.

#### ***Tune adjust in radio mode***

- Press ◀ to move to the next frequency down the band (whether or not a listenable station is located there). Hold the control to move through the frequencies quickly.
- Press ▶ to move to the next frequency up the band (whether or not a listenable station is located there). Hold for quick movement.



### ***Seek function***

The seek function control works in radio mode.

#### ***Seek function in radio mode***

- Press ◀ to find the next listenable station down the frequency band.
- Press ▶ to find the next listenable station up the frequency band.



### ***Scan function***

The scan function works in radio mode.



#### ***Scan function in radio mode***

Press the SCAN control to hear a brief sampling of all listenable stations on the frequency band. Press the SCAN control again to stop the scan mode.

#### ***Radio station memory preset***

The radio is equipped with six station memory preset controls. These controls can be used to select up to six preset AM stations and twelve FM stations (six in FM1 and six in FM2).

## Controls and features

### **Setting memory preset stations**

1. Select the frequency band with the AM or the FM select control.
2. Select a station. Refer to *Tune adjust* or *Seek function* for more information on selecting a station.
3. Press and hold a memory preset control until the sound returns, indicating the station is held in memory on the control you selected.

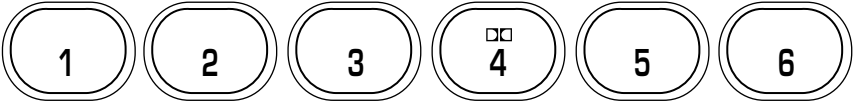

### **Bass adjust**

The bass adjust control allows you to increase or decrease the audio system's bass output.

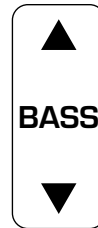

### **Treble adjust**

The treble adjust control allows you to increase or decrease the audio system's treble output.



## Controls and features

### **Speaker balance adjust**

Speaker sound distribution can be adjusted between the right and left speakers.

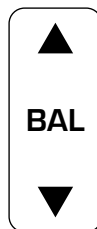

### **Speaker fade adjust**

Speaker sound can be adjusted between the front and rear speakers.

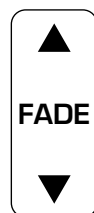

### **Tape select**

- To enter tape mode while in radio mode, press the TAPE AMS control.



### **Automatic Music Search**

The Automatic Music Search feature allows you to quickly locate the beginning of the tape selection being played or to skip to the next selection.

To activate the feature, momentarily depress the TAPE AMS button.

Then, press either REW (for the beginning of the current selection) or FF (to advance to the next





## Controls and features

selection). The tape deck stops and returns to play mode when the AMS circuit senses a blank section on the tape.

In order to ensure proper operation of the AMS feature, the tape **MUST** have a blank section of at least four seconds duration between programs.

### **Rewind**

The rewind control works in tape mode.

To rewind in tape mode, press the REW control.

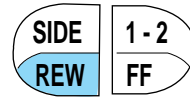

### **Fast forward**

The fast forward control works in tape mode.

- In the tape mode, tape direction will automatically reverse when the end of the tape is reached.

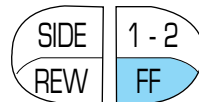

### **Tape direction select**

Press SIDE and 1-2 at the same time to play the alternate side of a tape.

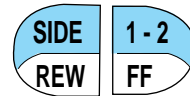

### **Eject function**

Press the control to stop and eject a tape.



### **Dolby® noise reduction**

Dolby® noise reduction operates only in tape mode. Dolby® noise reduction reduces the amount of hiss and static during tape playback.

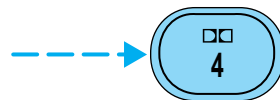

Press the  control to activate (and deactivate) Dolby® noise reduction.

Dolby® noise reduction is manufactured under license from Dolby® Laboratories Licensing Corporation. “Dolby®” and the double-D symbol are trademarks of Dolby Laboratories Licensing Corporation.

## Controls and features

### Setting the clock

Press CLK to toggle between listening frequencies and clock mode while in radio mode.

To set the hour, press and hold the CLK control and press the SEEK control:

- ◀ to decrease hours and
- ▶ to increase hours.

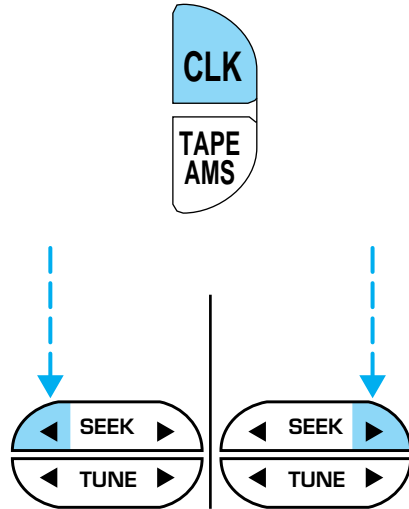

To set the minute, press and hold the CLK control and press the TUNE control:

- ◀ to decrease minutes and
- ▶ to increase minutes.

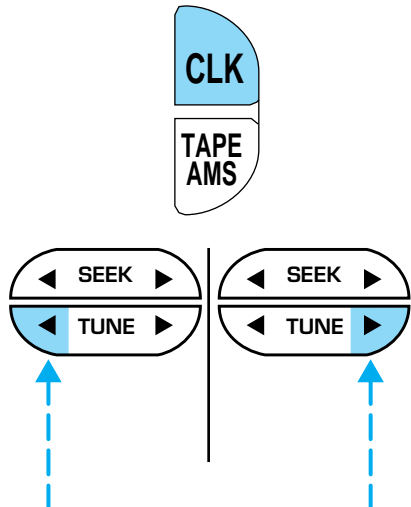

The CLK control will allow you to switch between media display mode (radio station, stereo information, etc.) and clock display mode (time).

## Controls and features

When in clock mode, the media information will display for 10 seconds, when the radio is turned on, and then revert to clock information. Anytime that the media is changed, (new radio station, etc.), the media information will again display for 10 seconds before reverting back to the clock. In media mode, the media information will always be displayed.

### AM/FM Stereo / Single CD Radio

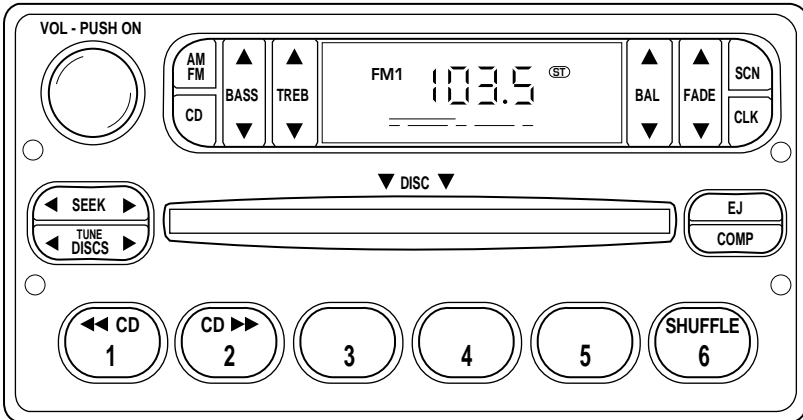

#### ***Volume/power control***

Press the control to turn the audio system on or off.

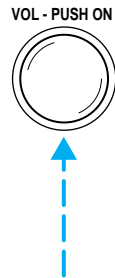

## Controls and features

Turn the control to raise or lower volume.



If the volume is set above a certain level and the ignition is turned off, the volume will come back on at a “nominal” listening level when the ignition switch is turned back on.

### **AM/FM select**

The AM/FM select control works in radio and CD modes.



### **AM/FM select in radio mode**

This control allows you to select AM or FM frequency bands. Press the control to switch between AM, FM1 or FM2 memory preset stations.

### **AM/FM select in CD mode**

Press this control to stop CD play and begin radio play.

### **Tune adjust**

The tune control works in radio and CD changer mode (if equipped).

### **Tune adjust in radio mode**

- Press ◀ to move to the next frequency down the band (whether or not a listenable station is located there). Hold the control to move through the frequencies quickly.



## Controls and features

- Press ► to move to the next frequency up the band (whether or not a listenable station is located there). Hold for quick movement.

### **Tune adjust for CD changer (if equipped)**

- Press ◀ to select the previous disc in the CD changer. (Play will begin on the first track of the disc unless the CD changer is in shuffle mode. Refer to *Shuffle feature* for more information. Hold the control to continue reversing through the disc.
- Press ► to select the next disc in the CD changer. Hold the control to fast-forward through the remaining discs.

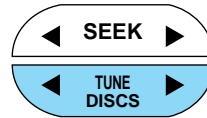

### **Seek function**

The seek function control works in radio or CD mode.

#### **Seek function in radio mode**

- Press ◀ to find the next listenable station down the frequency band.
- Press ► to find the next listenable station up the frequency band.

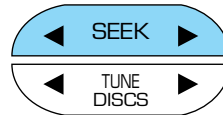

#### **Seek function for CD mode**

- Press ◀ to seek to the previous track of the current disc. If a selection has been playing for three seconds or more and you press ◀, the CD changer will replay that selection from the beginning.
- Press ► to seek forward to the next track of the current disc. After the last track has been completed, the first track of the current disc will automatically replay.

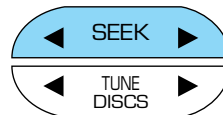

### **Scan function**

The scan function works in radio or CD mode.



## Controls and features

### ***Scan function in radio mode***

Press the SCAN control to hear a brief sampling of all listenable stations on the frequency band. Press the SCAN control again to stop the scan mode.

### ***Scan function in CD mode***

Press the SCAN control to hear a short sampling of all selections on the CD. (The CD scans in a forward direction, wrapping back to the first track at the end of the CD.) To stop on a particular selection, press the control again.

### ***Bass adjust***

The bass adjust control allows you to increase or decrease the audio system's bass output.

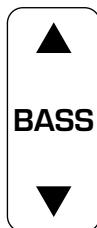

### ***Treble adjust***

The treble adjust control allows you to increase or decrease the audio system's treble output.



## Controls and features

### **Speaker balance adjust**

Speaker sound distribution can be adjusted between the right and left speakers.

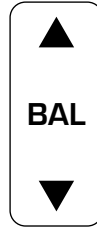

### **Speaker fade adjust**

Speaker sound can be adjusted between the front and rear speakers.



### **CD select**

- To begin CD play (if CD[s] are loaded), press the CD control. The first track of the disc will begin playing. After that, CD play will begin where it stopped last.

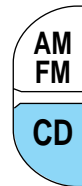

**Do not insert any promotional (odd shaped or sized) discs, or discs with removable labels into the CD player as jamming may occur.**

### **Rewind**

The rewind control works in CD mode.

To rewind in CD mode, press the CD control (preset 1).

Press the control again to deactivate rewind mode.



## Controls and features

### **Fast forward**

The fast forward control works in CD mode.

To fast forward in CD changer mode, press the CD control (preset 2).

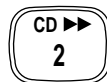

Press the control again to deactivate fast forward mode.

### **Eject function**

Press the control to stop and eject a CD.

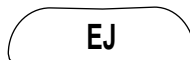

### **Compression feature**

Compression adjust brings soft and loud CD passages together for a more consistent listening level.



Press the COMP control to activate and deactivate compression adjust.

### **Shuffle feature (if equipped with CD changer)**

The shuffle feature operates in CD changer mode only and plays all tracks on the current disc in random order. The shuffle feature continues to the next disc after all tracks are played.



Press the SHUFFLE control to start this feature. Random order play will continue until the SHUFFLE control is pressed again.

### **Setting the clock**

Press CLK to toggle between listening frequencies and clock mode while in radio mode.

To set the hour, press and hold the CLK control and press the SEEK control:





## Controls and features

- ◀ to decrease hours and
- ▶ to increase hours.

To set the minute, press and hold the CLK control and press the TUNE control:

- ◀ to decrease minutes and
- ▶ to increase minutes.

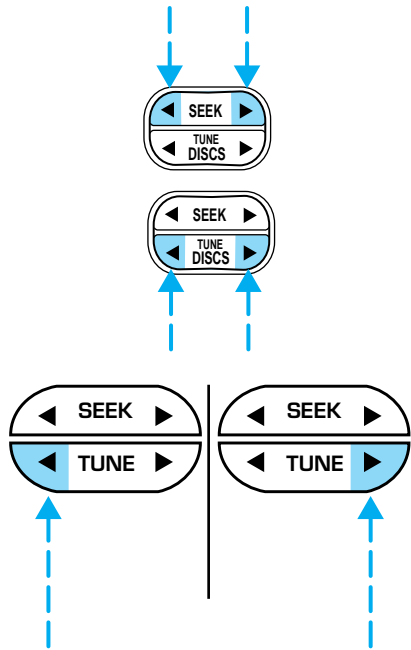

### Premium AM/FM Stereo/Cassette/Single CD

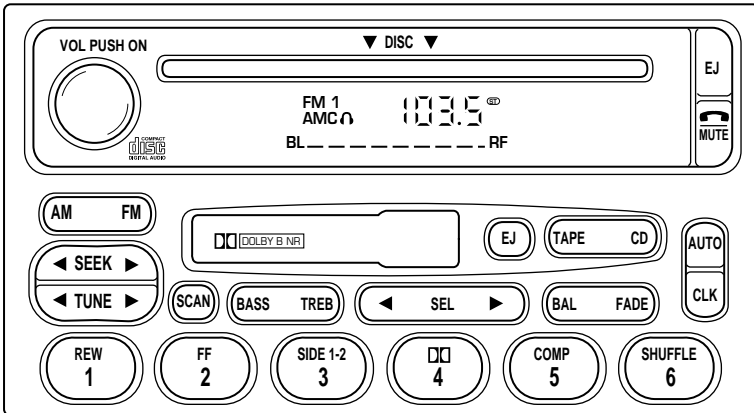

## Controls and features

### ***Volume/power control***

Press the control to turn the audio system on or off.

Audio power can also be turned on by pressing the AM/FM select control or the tape/CD select control. Audio power is turned off by using the volume/power control.

**VOL - PUSH ON**

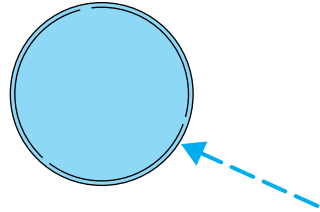

Turn control to raise or lower volume.

**VOL - PUSH ON**

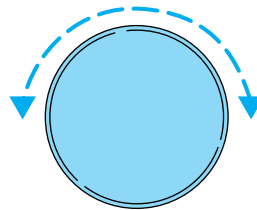

If the volume is set above a certain level and the ignition is turned off, the volume will come back on at a “nominal” listening level when the ignition switch is turned back on.

### ***AM/FM select***

The AM/FM select control works in radio, tape and CD modes.



### ***AM/FM select in radio mode***

This control allows you to select AM or FM frequency bands. Press the control to switch between AM, FM1 or FM2 memory preset stations.

### ***AM/FM select in tape mode***

Press this control to stop tape play and begin radio play.

### ***AM/FM select in CD or CD changer mode (if equipped)***

Press this control to stop CD play and begin radio play.

## Controls and features

### **Tune adjust**

The tune control works in radio or CD changer mode.

#### **Tune adjust in radio mode**

- Press ◀ to move to the next frequency down the band (whether or not a listenable station is located there). Hold the control to move through the frequencies quickly.
- Press ▶ to move to the next frequency up the band (whether or not a listenable station is located there). Hold for quick movement.

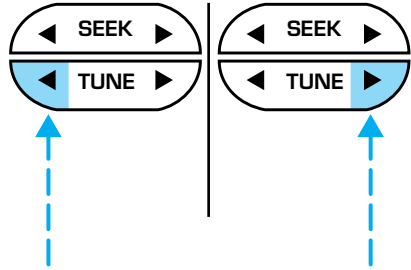

#### **Tune adjust for CD changer (if equipped)**

- Press ◀ to select the previous disc in the CD changer. (Play will begin on the first track of the disc unless the CD changer is in shuffle mode. Refer to *Shuffle feature* for more information. Hold the control to continue reversing through the remaining discs.
- Press ▶ to select the next disc in the CD changer. Hold the control to fast-forward through the remaining discs.

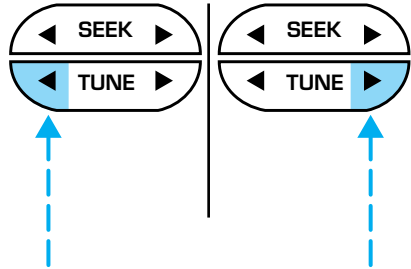

### **Seek function**

The seek function control works in radio, tape or CD mode.

## Controls and features

### **Seek function in radio mode**

- Press ◀ to find the next listenable station down the frequency band.
- Press ▶ to find the next listenable station up the frequency band.

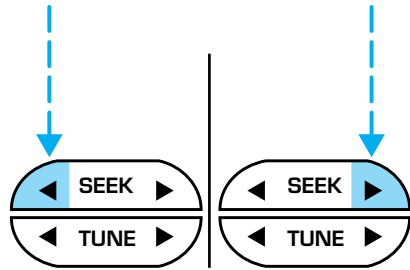

### **Seek function in tape mode**

- Press ◀ to listen to the previous selection on the tape.
- Press ▶ to listen to the next selection on the tape.

### **Seek function for CD or CD changer (if equipped)**

- Press ◀ to seek to the previous track of the current disc. If a selection has been playing for three seconds or more and you press ◀, the CD changer will replay that selection from the beginning.
- Press ▶ to seek forward to the next track of the current disc. After the last track has been completed, the first track of the current disc will automatically replay.

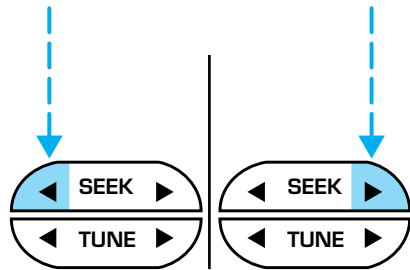

### **Scan function**

The scan function works in radio, tape or CD mode.



### **Scan function in radio mode**

Press the SCAN control to hear a brief sampling of all listenable stations on the frequency band. Press the control again to stop the scan mode.

## Controls and features

### **Scan function in tape mode**

Press the SCAN control to hear a short sampling of all selections on the tape. (The tape scans in a forward direction. At the end of the tape's first side, direction automatically reverses to the opposite side of the tape.) To stop on a particular selection, press the control again.

### **Scan function in CD or CD changer mode (if equipped)**

Press the SCAN control to hear a short sampling of all selections on the CD. (The CD scans in a forward direction, wrapping back to the first track at the end of the CD.) To stop on a particular selection, press the control again.

### **Radio station memory preset**

The radio is equipped with six station memory preset controls. These controls can be used to select up to six preset AM stations and twelve FM stations (six in FM1 and six in FM2).

### **Setting memory preset stations**



1. Select the frequency band with the AM/FM select control.
2. Select a station. Refer to *Tune adjust* or *Seek function* for more information on selecting a station.

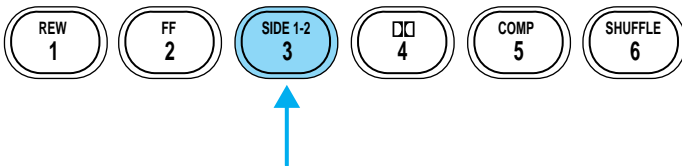

3. Press and hold a memory preset control until the sound returns, indicating the station is held in memory on the control you selected.

### **Autoset memory preset**

Autoset allows you to set strong radio stations without losing your original manually set preset stations. This feature is helpful on trips when you travel between cities with different radio stations.

## Controls and features

### Starting autoselect memory preset

1. Select a frequency using the AM/FM select controls.
2. Press the AUTO control.
3. When the first six strong stations are filled, the station stored in memory preset control 1 will start playing.

If there are less than six strong stations available on the frequency band, the remaining memory preset controls will all store the last strong station available.

These stations are temporarily stored in the memory preset controls (until deactivated) and are accessed in the same manner of your original presets.

To deactivate autoselect and return to your audio system's manually set memory stations, press the AUTO control again.

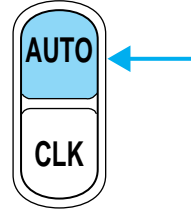

### Bass adjust

The bass adjust control allows you to increase or decrease the audio system's bass output.

Press the BASS control then press:

- ◀ to decrease the bass output and
- ▶ to increase the bass output.

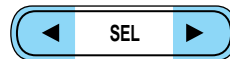
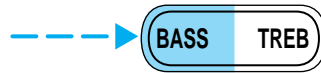

### Treble adjust

The treble adjust control allows you to increase or decrease the audio system's treble output.



## Controls and features

Press the TREB control then press:

- ◀ to decrease the treble output and
- ▶ to increase the treble output.

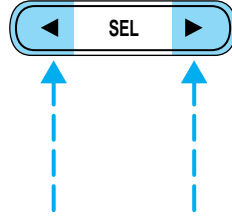

### **Speaker balance adjust**

Speaker sound distribution can be adjusted between the right and left speakers.

Press the BAL control then press:

- ◀ to shift sound to the left and
- ▶ to shift sound to the right.

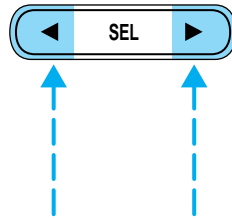
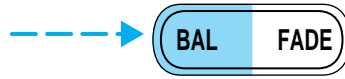

### **Speaker fade adjust**

Speaker sound can be adjusted between the front and rear speakers.

Press the FADE control then press:

- ▶ to shift the sound to the front and
- ◀ to shift the sound to the rear.

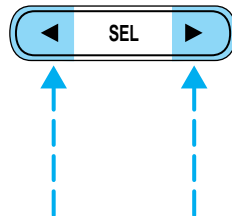

## Controls and features

### ***Tape/CD select***

- To begin tape play (with a tape loaded into the audio system) while in the radio or CD mode, press the TAPE control. Press the button during rewind or fast forward to stop the rewind or fast forward function.
- To begin CD play (if CD(s) are loaded), press the CD control. The first track of the disc will begin playing. If returning from radio or tape mode, CD play will begin where it stopped last.



With the dual media audio system, press the CD control to toggle between single CD and CD changer play (if equipped).

**Do not insert any promotional (odd shaped or sized) discs, or discs with removable labels into the CD player as jamming may occur.**

### ***Rewind***

The rewind control works in tape and CD modes.

- In tape mode, radio play will continue until rewind is stopped (with the TAPE control) or the beginning of the tape is reached.
- In CD mode, pressing the REW control rewinds the CD within the current track.

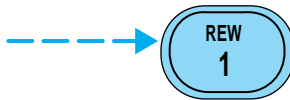

### ***Fast forward***

The fast forward control works in tape and CD modes.

- In the tape mode, tape direction will automatically reverse when the end of the tape is reached.
- In CD mode, pressing the control fast forwards the CD within the current track.

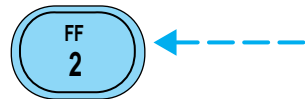



## Controls and features

### ***Tape direction select***

Press SIDE 1-2 to play the alternate side of a tape.

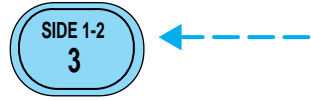

### ***Eject function***

Press the EJ control to stop and eject a tape.

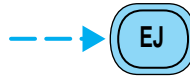

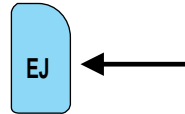

Press the EJ control to stop and eject a CD.

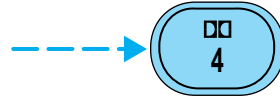

### ***Dolby® noise reduction***

Dolby® noise reduction operates in tape mode. Dolby® noise reduction reduces the amount of hiss and static during tape playback.



Press the  control to activate (and deactivate) the Dolby® noise reduction.

Dolby® noise reduction is manufactured under license from Dolby® Laboratories Licensing Corporation. “Dolby®” and the double-D symbol  are trademarks of Dolby® Laboratories Licensing Corporation.

### ***Compression adjust***

Compression adjust brings soft and loud CD passages together for a more consistent listening level.

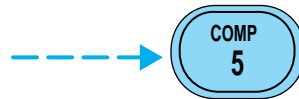

Press the COMP control to activate and deactivate compression adjust.

## Controls and features

### Shuffle feature

The shuffle feature operates in CD mode (if equipped) and plays all tracks on the current disc in random order. If equipped with the CD changer, the shuffle feature continues to the next disc after all tracks on the current disc are played.

Press the SHUFFLE control to start this feature. Random order play will continue until the SHUFFLE control is pressed again.

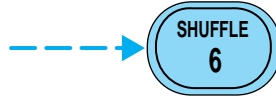

### Setting the clock

To set the hour, press and hold the CLK control and press SEEK:

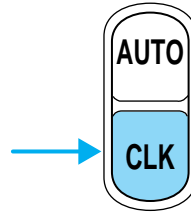

- ◀ to decrease hours and
- ▶ to increase hours.

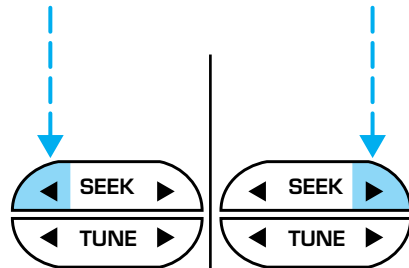

To set the minute, press and hold the CLK control and press TUNE:

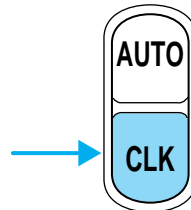

## Controls and features

- ◀ to decrease minutes and
- ▶ to increase minutes.

If your vehicle has a separate clock module, (other than the digital radio display), the CLK button will not function in the above manner.

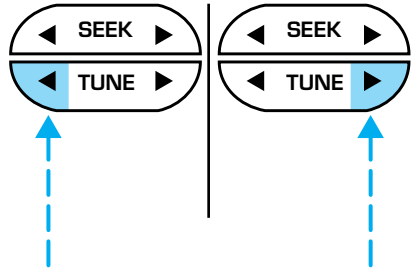

The CLK button will allow you to switch between media display mode (radio station, stereo information, etc.) and clock display mode (time). When in clock mode, the media information will display for 10 seconds, when the radio is turned on, and then revert to clock information. Anytime that the media is changed, (new radio station, etc.), the media information will again display for 10 seconds before reverting back to the clock. In media mode, the media information will always be displayed.

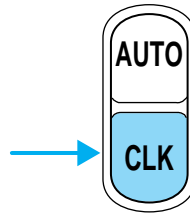

### **Mute mode**

Press the control to mute the playing media. Press the control again to return to the playing media.

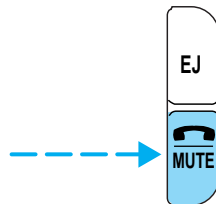

## Controls and features

### Rear seat controls (if equipped)

The Personal Audio System, a feature of the optional Premium AM/FM Stereo/Cassette/Single CD and the MACH® Audio System with AM/FM Stereo/Cassette/Single CD, allows front and middle seat passengers to listen to different media sources (radio, cassette or CD) simultaneously. However, the front and middle-seat passengers cannot listen to two different radio stations at the same time.

To turn on the rear seat controls, press the memory preset controls 3 and 5 at the same time. The  will appear in the display.

Pressing 3 and 5 at the same time again will turn the rear seat controls off.

If there is a discrepancy between the rear seat and the front audio controls, (such as both trying to listen to the same playing media), the front audio system will receive the desired selection.

To activate the Personal Audio System, press the speaker/headphone control. Press the MODE control to change audio sources (for headphone mode only). Use the SEEK, VOLUME and MEMORY controls to make adjustments to the playing media.

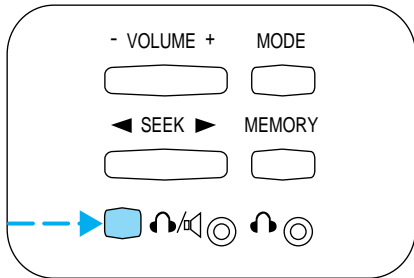
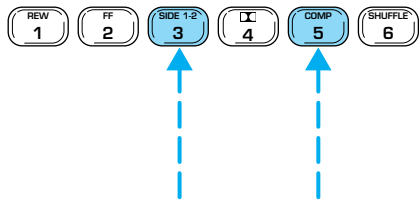
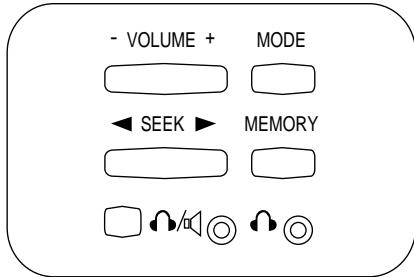

## Controls and features

### Adjusting the volume

Press the + control to increase volume.

Press the - control to decrease volume.

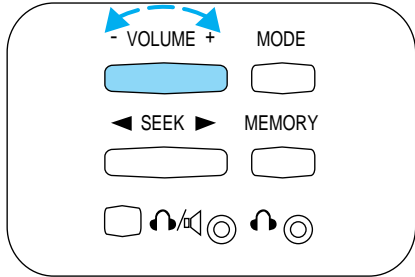

From the rear seat controls, volume control can be set no higher than the current radio setting unless the speakers are turned off. Refer to *Turning speakers on and off*.

### Turning the speakers on and off

Press to turn all speakers on or off.

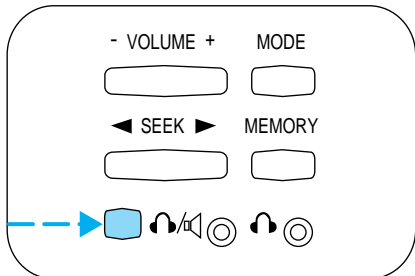

### Using headphones

Plug a 3.5 mm headphone (not included) into the  jack. Press the speaker on/off control to operate the headphones.

The rear speakers will cut out once the speaker on/off control is pressed. The front speaker will remain playing for the front passengers. Press the control again to deactivate the headphones.

## Controls and features

### Mode select

Push the MODE control to toggle between AM, FM1, FM2, tape, CD or CD changer (if equipped).

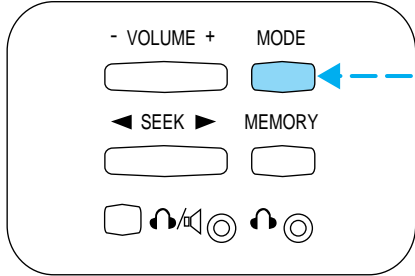

### Memory preset control

Push the MEMORY control successively to allow rear seat passengers to scroll through the 6 memory presets in AM, FM1 or FM2.

Push the MEMORY control in CD changer mode (if equipped) to advance to the next disc.

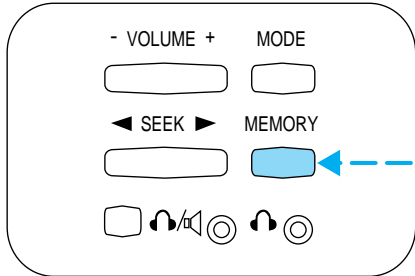

### Seek function

- In radio mode, press ◀ to find the next listenable station down the frequency band.
- In radio mode, press ▶ to find the next listenable station up the frequency band.
- In tape mode, use the SEEK function to access the next ▶ or previous ◀ selection.
- In CD mode (if equipped), use the SEEK function to access the next ▶ or previous ◀ selection.

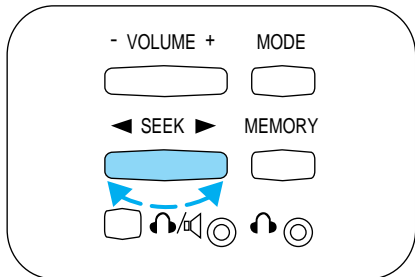

## Controls and features

### MACH® Audio System with AM/FM Stereo/Cassette/Single CD

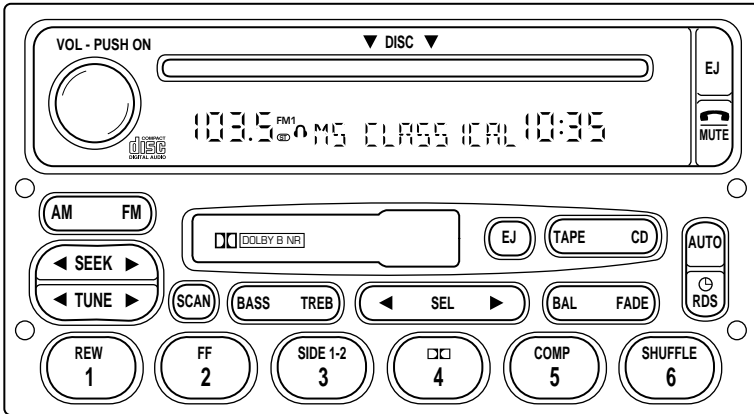

#### **Volume/power control**

Press the control to turn the audio system on or off.

VOL - PUSH ON

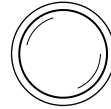

Turn control to raise or lower volume.

BAL FADER

VOL - PUSH ON

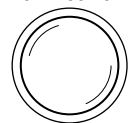

If the volume is set above a certain level and the ignition is turned off, the volume will come back on at a “nominal” listening level when the ignition switch is turned back on. If you wish to maintain your preset volume level, turn the audio system off with the power control before switching off the ignition.

## Controls and features

### **AM/FM select**

The AM/FM select control works in radio, tape and CD modes.

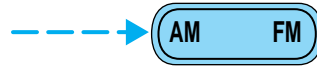

### **AM/FM select in radio mode**

This control allows you to select AM or FM frequency bands. Press the control to switch between AM, FM1 or FM2 memory preset stations.

### **AM/FM select in tape mode**

Press this control to stop tape play and begin radio play.

### **AM/FM select in CD mode**

Press this control to stop CD play and begin radio play.

### **Tune adjust**

The tune control works in radio or CD mode.

### **Tune adjust in radio mode**

- Press ◀ to move to the next frequency down the band (whether or not a listenable station is located there). Hold the control to move through the frequencies quickly.
- Press ▶ to move to the next frequency up the band (whether or not a listenable station is located there). Hold for quick movement.

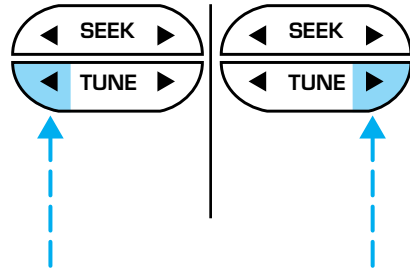



## Controls and features

### **Tune adjust for CD changer (if equipped)**

- Press ◀ to select the previous disc in the CD changer. (Play will begin on the first track of the disc unless the CD changer is in shuffle mode. Refer to *Shuffle feature* for more information. Hold the control to continue reversing through the disc.
- Press ▶ to select the next disc in the CD changer. Hold the control to fast-forward through the remaining discs.

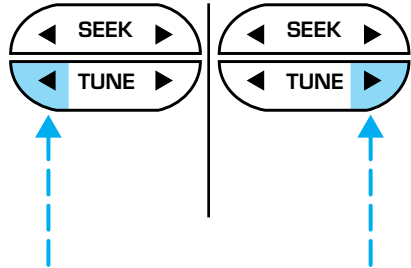

### **Seek function**

The seek function control works in radio, tape or CD mode.

#### **Seek function in radio mode**

- Press ◀ to find the next listenable station down the frequency band.
- Press ▶ to find the next listenable station up the frequency band.

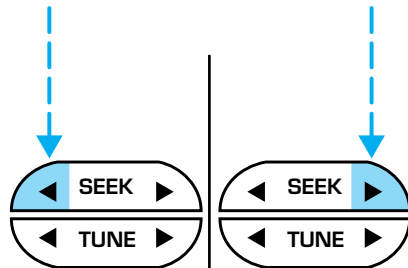

#### **Seek function in tape mode**

- Press ◀ to listen to the previous selection on the tape.
- Press ▶ to listen to the next selection on the tape.

## Controls and features

### **Seek function for CD changer (if equipped)**

- Press ◀ to seek to the previous track of the current disc. If a selection has been playing for three seconds or more and you press ◀, the CD changer will replay that selection from the beginning.
- Press ▶ to seek forward to the next track of the current disc. After the last track has been completed, the first track of the current disc will automatically replay.

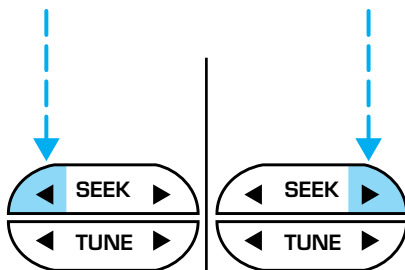

### **Scan function**

The scan function works in radio, tape or CD mode.



### **Scan function in radio mode**

Press the SCAN control to hear a brief sampling of all listenable stations on the frequency band. Press the control again to stop the scan mode.

### **Scan function in tape mode**

Press the SCAN control to hear a short sampling of all selections on the tape. (The tape scans in a forward direction. At the end of the tape's first side, direction automatically reverses to the opposite side of the tape.) To stop on a particular selection, press the control again.

### **Scan function in CD mode**

Press the SCAN control to hear a short sampling of all selections on the CD. (The CD scans in a forward direction, wrapping back to the first track at the end of the CD.) To stop on a particular selection, press the control again.

### **Radio station memory preset**

The radio is equipped with six station memory preset controls. These controls can be used to select up to six preset AM stations and twelve FM stations (six in FM1 and six in FM2).

## Controls and features

### Setting memory preset stations

1. Select the frequency band with the AM/FM select control.
2. Select a station. Refer to *Tune adjust* or *Seek function* for more information on selecting a station.
3. Press and hold a memory preset control until the sound returns, indicating the station is held in memory on the control you selected.

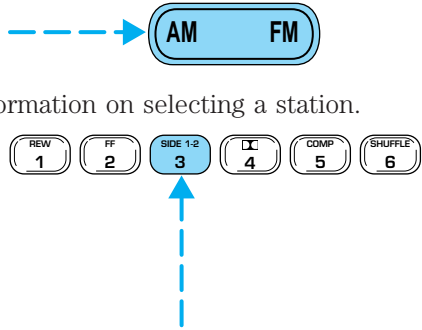

### Autoset memory preset

Autoset allows you to set strong radio stations without losing your original manually set preset stations. This feature is helpful on trips when you travel between cities with different radio stations.

### Starting autoset memory preset

1. Select a frequency using the AM/FM select controls.
2. Press the AUTO control.
3. When the first six strong stations are filled, the station stored in memory preset control 1 will start playing.

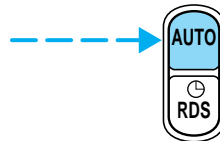

If there are less than six strong stations available on the frequency band, the remaining memory preset controls will all store the last strong station available.

To deactivate autoset and return to your audio system's manually set memory stations, press the AUTO control again.

### Bass adjust

The bass adjust control allows you to increase or decrease the audio system's bass output.

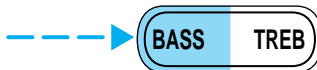

## Controls and features

Press the BASS control then press:

- ◀ to decrease bass output and
- ▶ to increase bass output.

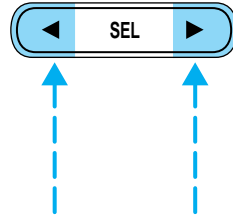

### **Treble adjust**

The treble adjust control allows you to increase or decrease the audio system's treble output.

Press the TREB control then press:

- ◀ to decrease treble output and
- ▶ to increase treble output.

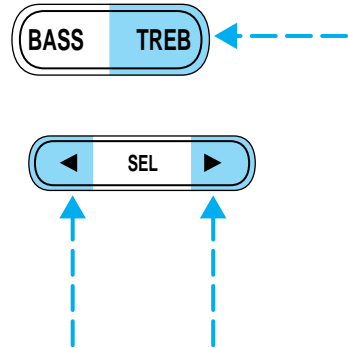

### **Speaker balance adjust**

Speaker sound distribution can be adjusted between the right and left speakers.

Press the BAL control then press:

- ◀ to shift sound to the left and
- ▶ to shift sound to the right.

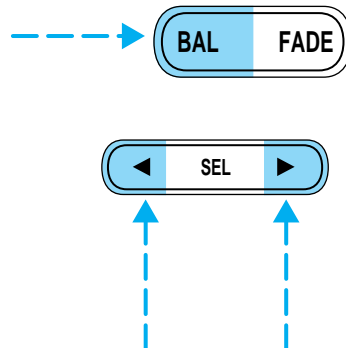



## Controls and features

### **Speaker fade adjust**

Speaker sound can be adjusted between the front and rear speakers.

Press the FADE control then press:

-  to shift sound to the front and
-  to shift sound to the rear.

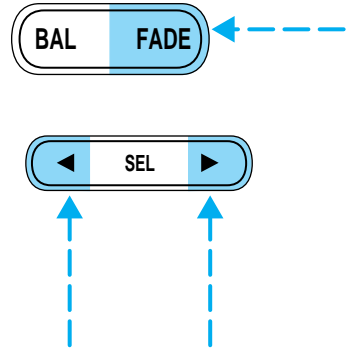

### **Tape/CD/CD changer (if equipped) select**

- To begin tape play (with a tape loaded into the audio system) while in the radio or CD mode, press the TAPE control. Press the button during rewind or fast forward to stop the rewind or fast forward function.
- To begin CD play (if CD(s) are loaded), press the CD control. The first track of the disc will begin playing. After that CD play will begin where it stopped last.

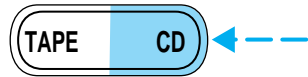

If equipped with a CD changer, press the CD control to toggle between single CD and CD changer play.

**Do not insert any promotional (odd shaped or sized) discs, or discs with removable labels into the CD player as jamming may occur.**

### **Rewind**

The rewind control works in tape and CD modes.

- In tape mode, radio play will continue until rewind is stopped (with the TAPE control) or the beginning of the tape is reached.

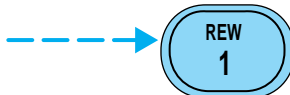

## Controls and features

- In CD mode, pressing the REW control for less than three seconds results in slow rewind. Pressing the control for more than three seconds results in fast rewind.

### **Fast forward**

The fast forward control works in tape and CD modes.

- In the tape mode, tape direction will automatically reverse when the end of the tape is reached.
- In CD mode, pressing the control for less than three seconds results in slow forward action. Pressing the control for more than three seconds results in fast forward action.

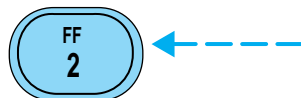

### **Tape direction select**

Press SIDE 1-2 to play the alternate side of a tape.

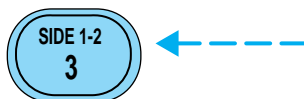

### **Eject function**

Press the control to stop and eject a tape.

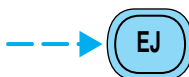

Press the control to stop and eject a CD.

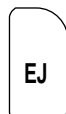

### **Dolby® noise reduction**

Dolby® noise reduction operates only in tape mode. Dolby® noise reduction reduces the amount of hiss and static during tape playback.

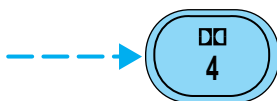

Press the  control to activate (and deactivate) Dolby® noise reduction.

The Dolby® noise reduction system is manufactured under license from Dolby Laboratories Licensing Corporation. Dolby® and the double-D symbol are trademarks of Dolby® Laboratories Licensing Corporation.

## Controls and features

### **Compression adjust**

Compression adjust brings soft and loud CD passages together for a more consistent listening level.

Press the COMP control to activate and deactivate compression adjust.

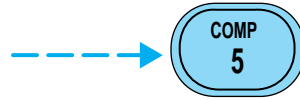

### **Shuffle feature**

The shuffle feature operates in CD mode and plays all tracks on the current disc in random order. If equipped with the CD changer, the shuffle feature continues to the next disc after all tracks on the current disc are played.

Press the SHUFFLE control to start this feature. Random order play will continue until the SHUFFLE control is pressed again.

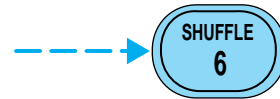

### **Setting the clock**

Press the clock/RDS control until SELECT HOUR is displayed and press:

- ◀ to decrease hours and
- ▶ to increase hours.

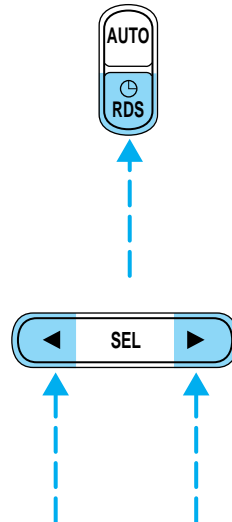

## Controls and features

To set the minute, press the clock/RDS control until SELECT MIN is displayed and press:

- ◀ to decrease minutes and
- ▶ to increase minutes.

### **Radio Data System (RDS) feature**

This feature allows your audio system to receive text information from RDS-equipped FM radio stations.

Press and hold the control for three seconds to turn the feature on or off. Press the control to scroll through the following selections:

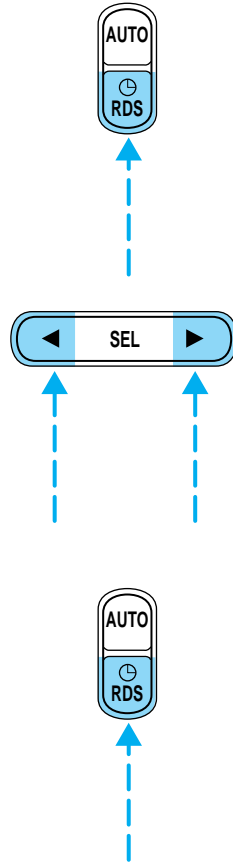



## Controls and features

### ***RDS traffic announcement***

- Press the RDS control until TRAFFIC is displayed.



- Use the SELECT control to select ON or OFF. With the feature ON, use the SEEK or SCAN control to find a radio station broadcasting a traffic report (if it is broadcasting RDS data).



### ***RDS select program type***

- Press the RDS control until FIND program type is displayed.



## Controls and features

- Use the SEL control to select the program type. With the feature on, use the SEEK or AUTOSET or SCAN control to find the desired program type from the following selections:

- Classic
- Country
- Info
- Jazz/R&B
- Religious
- Rock
- Soft
- Top 40

### **RDS show**

- With the RDS menu enabled, press the RDS control until SHOW is displayed.

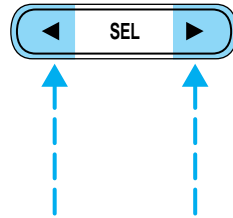

- Use the SEL control to select TYPE, NAME, TEXT or NONE. When your radio is turned to a RDS station, RDS station TYPE, station NAME, or TEXT message will be displayed along with the frequency. Press SEL in order to scroll through the text messages.

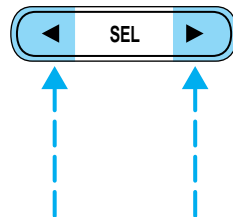

## Controls and features

### Mute mode

Press the control to mute the playing media. Press the control again to return to the playing media.

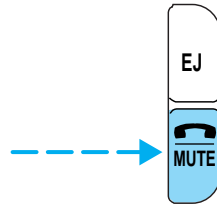

### Rear seat controls (if equipped)

The Personal Audio System, a feature of the optional Premium AM/FM Stereo/Cassette/Single CD and the MACH® Audio System with AM/FM Stereo/Cassette/Single CD, allows front and middle seat passengers to listen to different media sources (radio, cassette or CD) simultaneously. However, the front and middle-seat passengers cannot listen to two different radio stations at the same time.

To turn on the rear seat controls, press the memory preset controls 3 and 5 at the same time. The  will appear in the display.

Pressing 3 and 5 at the same time again will turn the rear seat controls off.

If there is a discrepancy between the rear seat and the front audio controls, (such as both trying to listen to the same playing media), the front audio system will receive the desired selection.

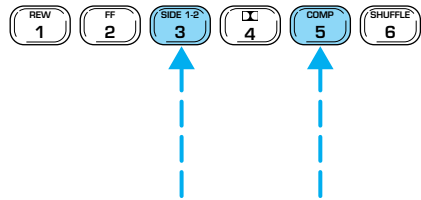
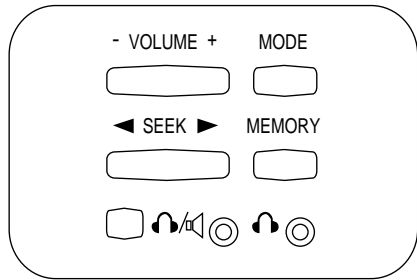

## Controls and features

To activate the Personal Audio System, press the speaker/headphone control. Press the MODE control to change audio sources (for headphone mode only). Use the SEEK, VOLUME and MEMORY controls to make adjustments to the playing media.

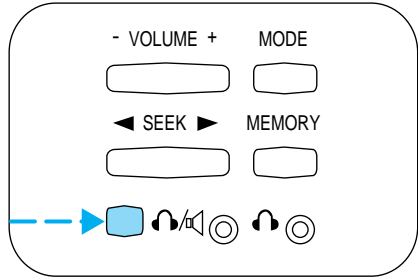

### **Adjusting the volume**

Press the + control to increase volume.

Press the - control to decrease volume.

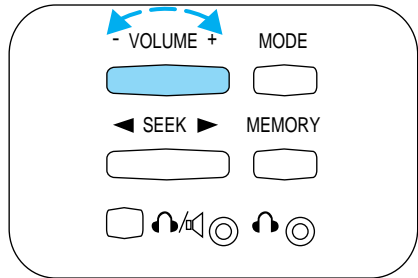

From the rear seat controls, volume control can be set no higher than the current radio setting unless the speakers are turned off. Refer to *Turning speakers on and off*.

### **Turning the speakers on and off**

Press to turn all speakers on or off.

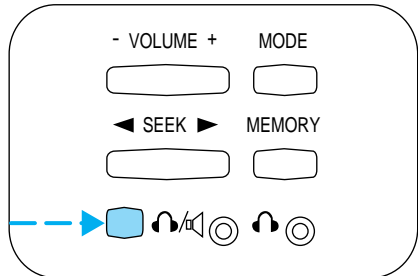

## Controls and features

### Using headphones

Plug a 3.5 mm headphone (not included) into the  jack. Press the speaker on/off control to operate the headphones.

The rear speakers will cut out once the speaker on/off control is pressed. The front speaker will remain playing for the front passengers. Press the control again to deactivate the headphones.

### Mode select

Push the MODE control to toggle between AM, FM1, FM2, tape, CD or CD changer (if equipped).

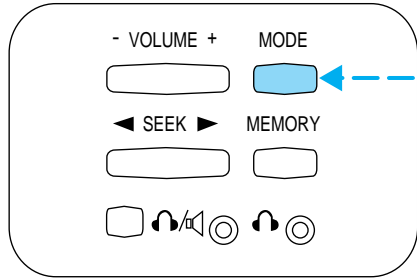

### Memory preset control

Push the MEMORY control successively to allow rear seat passengers to scroll through the 6 memory presets in AM, FM1 or FM2.

Push the MEMORY control in CD changer mode (if equipped) to advance to the next disc.

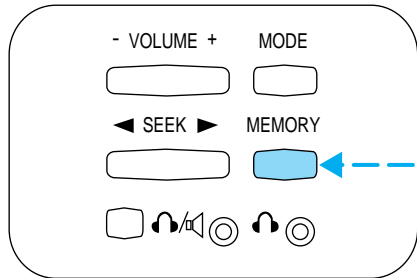

## Controls and features

### Seek function

- In radio mode, press ◀ to find the next listenable station down the frequency band.
- In radio mode, press ▶ to find the next listenable station up the frequency band.
- In tape mode, use the SEEK function to access the next ▶ or previous ◀ selection.
- In CD mode (if equipped), use the SEEK function to access the next ▶ or previous ◀ selection.

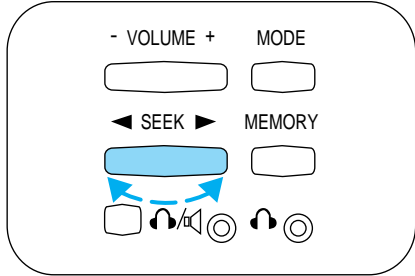

### CD changer (if equipped)

The CD changer is located in one of the following locations:

- in the trunk
- in the center console
- under the driver's seat

1. Slide the door to access the CD changer magazine.

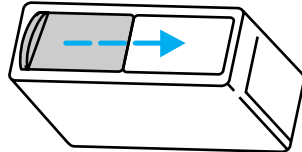

## Controls and features

2. Press  to eject the magazine.

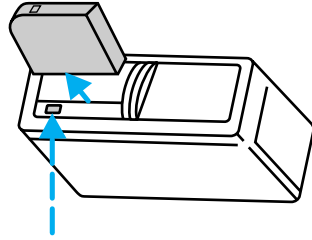

3. Turn the magazine (A) over.

4. Using the disc holder release knob (C), pull the disc holder (B) out of the magazine.

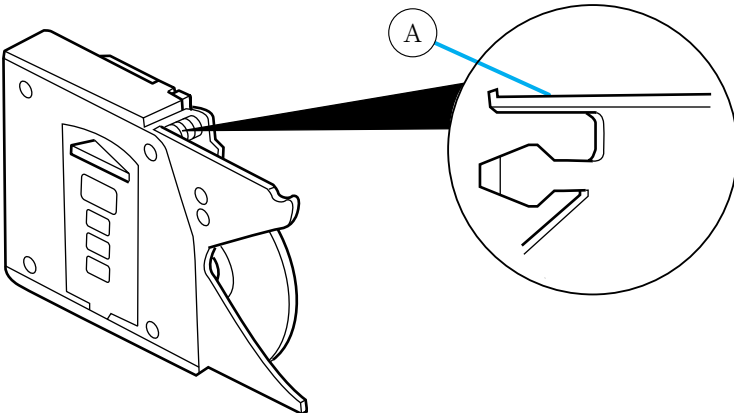
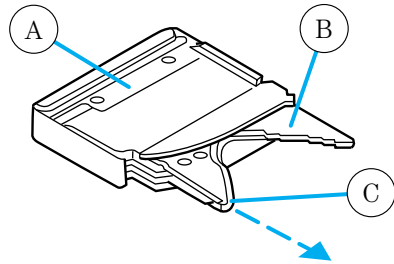

If you pull too hard on the disc holder, the disc holder may come completely out of the magazine. If this happens, reinsert the disc holder back into the magazine while pressing on the lever (A).

## Controls and features

5. Line up the CD with the groove of the disc holder. Ensure that the label on the CD faces downwards.

6. Press in on the disc holder until it locks securely into the magazine. If the disc holders are not fully locked into the magazine, the unit will not operate.

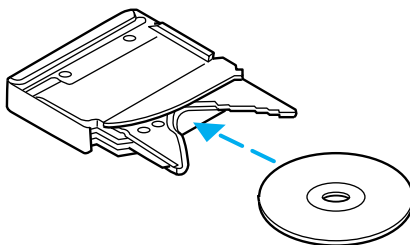

Ensure that the disc holder is evenly inserted and at the same level as the magazine (A). The unit will not operate if the disc holder is not inserted at the same level (B).

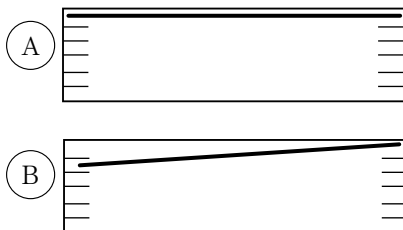

Radio power must be turned on to play the CDs in the changer. The magazine may be stored in the glove box when not being used.

The CD magazine may be inserted or ejected with the radio power off. **ONLY** use the magazine supplied with the CD changer, other types will damage the unit.

Keep the CD changer door closed. Coins and foreign objects will damage the CD player and void your audio system warranty.

**Do not insert any promotional (odd shaped or sized) discs, or discs with removable labels into the CD player as jamming may occur.**

### Troubleshooting the CD changer (if equipped)



The laser beam used in the compact disc player is harmful to the eyes. Do not attempt to disassemble the case.

If sound skips:

- You may be traveling on a rough road, playing badly scratched discs or the disc may be dirty. Skipping will not scratch the discs or damage the player.



## Controls and features

If your changer does not work, it may be that:

- A disc is already loaded where you want to insert a disc.
- The disc is inserted with the label surface downward.
- The disc is dusty or defective.
- The player's internal temperature is above 60°C (140°F). Allow the player to cool down before operating.
- A disc with format and dimensions not within industry standards is inserted.

### Cleaning compact discs

Inspect all discs for contamination before playing. If necessary, clean discs only with an approved CD cleaner and wipe from the center out to the edge. Do not use circular motion.

### CD and CD changer care

- Handle discs by their edges only. Never touch the playing surface.
- Do not expose discs to direct sunlight or heat sources for extended periods of time.
- Do not insert more than one disc into each slot of the CD changer magazine.

**Do not insert any promotional (odd shaped or sized) discs, or discs with removable labels into the CD player as jamming may occur.**

### Cleaning cassette player (if equipped)

Clean the tape player head with a cassette cleaning cartridge after 10 to 12 hours of play in order to maintain the best sound and operation.

### Cassette and cassette player care

- Use only cassettes that are 90 minutes long or less.
- Do not expose tapes to direct sunlight, high humidity, extreme heat or extreme cold. Allow tapes that may have been exposed to extreme temperatures to reach a moderate temperature before playing.
- Tighten very loose tapes by inserting a finger or pencil into the hole and turning the hub.
- Remove loose labels before inserting tapes.

## Controls and features

- Do not leave tapes in the cassette player for a long time when not being played.

### Radio frequency information

The Federal Communications Commission (FCC) and the Canadian Radio and Telecommunications Commission (CRTC) establish the frequencies AM and FM stations may use for their broadcasts. Allowable frequencies are:

AM 530, 540–1600, 1610 kHz

FM 87.7, 87.9–107.7, 107.9 MHz

Not all frequencies are used in a given area.

### Radio reception factors

Three factors can affect radio reception:

- **Distance/strength.** The further an FM signal travels, the weaker it is. The listenable range of the average FM station is approximately 40 km (24 miles). This range can be affected by “signal modulation.” Signal modulation is a process radio stations use to increase their strength/volume relative to other stations.
- **Terrain.** Hills, mountains and tall buildings between your vehicle’s antenna and the radio station signal can cause FM reception problems. Static can be caused on AM stations by power lines, electric fences, traffic lights and thunderstorms. Moving away from an interfering structure (out of its “shadow”) returns your reception to normal.
- **Station overload.** Weak signals are sometimes captured by stronger signals when you pass a broadcast tower. A stronger signal may temporarily overtake a weaker signal and play while the weak station frequency is displayed.

The audio system automatically switches to single channel reception if it will improve the reception of a station normally received in stereo.

### Audio system warranties and service

Refer to the “Warranty Guide” for audio system warranty information.

If service is necessary, see your dealer or a qualified technician.

## Controls and features

### TURN SIGNAL CONTROL ⇐⇒

- Push down to activate the left turn signal.
- Push up to activate the right turn signal.

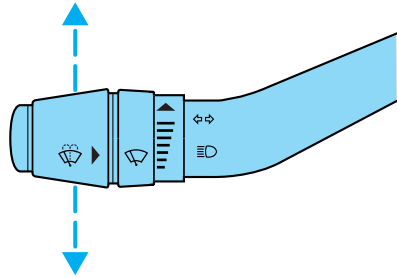

### POSITIONS OF THE IGNITION

1. ACCESSORY, allows the electrical accessories such as the radio to operate while the engine is not running.

2. LOCK, locks the steering wheel, automatic transmission gearshift lever and allows key removal.

3. OFF, shuts off the engine and all accessories without locking the steering wheel.

4. ON, all electrical circuits operational. Warning lights illuminated. Key position when driving.

5. START, cranks the engine. Release the key as soon as the engine starts.

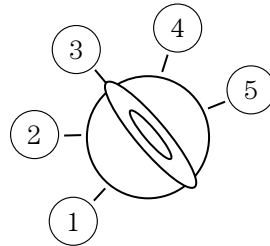

## Controls and features

### SPEED CONTROL (IF EQUIPPED)

#### To turn speed control on

- Press ON.

Vehicle speed cannot be controlled until the vehicle is traveling at or above 48 km/h (30 mph).

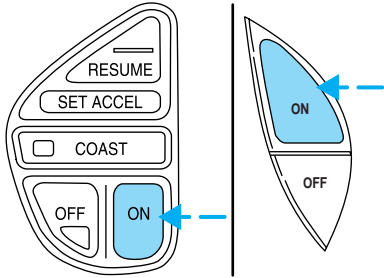

Do not use the speed control in heavy traffic or on roads that are winding, slippery, or unpaved.



Do not shift the gearshift lever into N (Neutral) with the speed control on.

#### To turn speed control off

- Press OFF or
- Turn off the vehicle ignition.

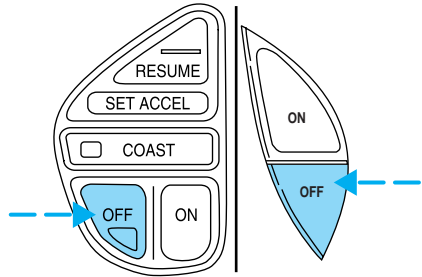

Once speed control is switched off, the previously programmed set speed will be erased.

## Controls and features

### To set a speed

- Press SET/SET ACC/SET ACCEL. For speed control to operate, the speed control must be ON and the vehicle speed must be greater than 48 km/h (30 mph).

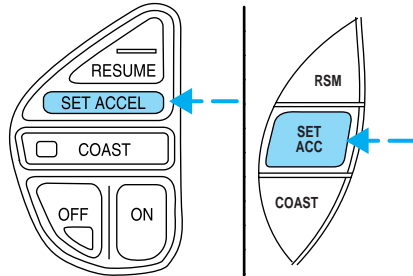

If you drive up or down a steep hill, your vehicle speed may vary momentarily slower or faster than the set speed. This is normal.

Speed control cannot reduce the vehicle speed if it increases above the set speed on a downhill. If your vehicle speed is faster than the set speed while driving on a downhill, you may want to shift to the next lower gear or apply the brakes to reduce your vehicle speed.

If your vehicle slows down more than 16 km/h (10 mph) below your set speed on an uphill, your speed control will disengage. This is normal. Pressing RES/RSM/RESUME will re-engage it.



Do not use the speed control in heavy traffic or on roads that are winding, slippery, or unpaved.

### To set a higher set speed

- Press and hold SET/SET ACC/SET ACCEL. Release the control when the desired vehicle speed is reached or
- Press and release SET/SET ACC/SET ACCEL to operate the Tap-Up function. Each press will increase the set speed by 1.6 km/h (1 mph) or
- Accelerate with your accelerator pedal. When the desired vehicle speed is reached, press and release SET/SET ACC/SET ACCEL.

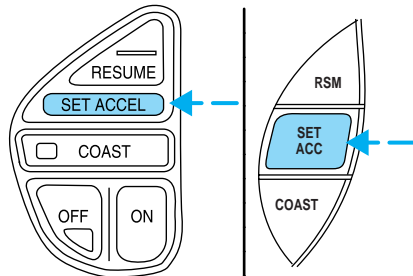

## Controls and features

You can accelerate with the accelerator pedal at any time during speed control usage. Releasing the accelerator pedal will return your vehicle to the previously programmed set speed.

### To set a lower set speed

- Press and hold CST/COAST. Release the control when the desired speed is reached or
- Press and release CST/COAST to operate the Tap-Down function. Each press will decrease the set speed by 1.6 km/h (1 mph) or
- Depress the brake pedal. When the desired vehicle speed is reached, press SET/SET ACC/SET ACCEL.

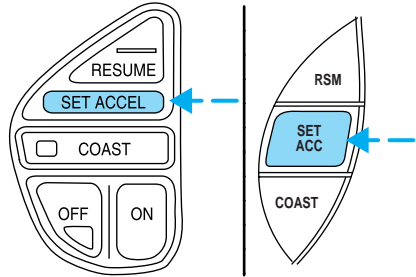
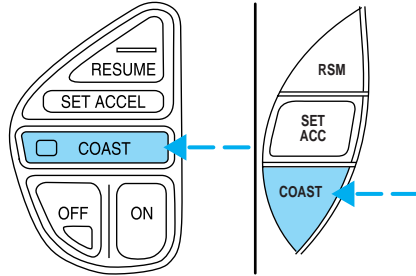

## Controls and features

### To disengage speed control

- Depress the brake pedal or

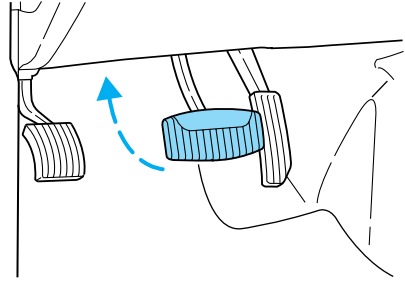

- Depress the clutch pedal (if equipped).

Disengaging the speed control will not erase the previously programmed set speed.

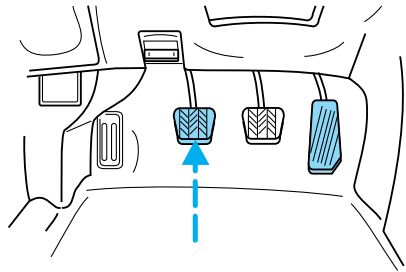

Pressing OFF will erase the previously programmed set speed.

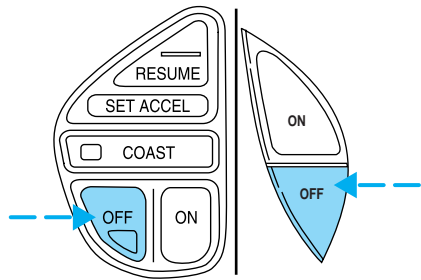

## Controls and features

### To return to a previously set speed

- Press RES/RSM/RESUME. For RES/RSM/RESUME to operate, the vehicle speed must be faster than 48 km/h (30 mph).

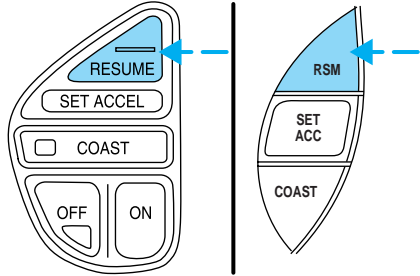

### Indicator light

This light comes on when either the SET ACCEL or RES controls are pressed. It turns off when the speed control OFF control is pressed, the brake is applied or the ignition is turned to the OFF position.

**SPEED  
CONT**



## Controls and features

### TILT STEERING WHEEL (IF EQUIPPED)

Pull the tilt steering control toward you to move the steering wheel up or down. Hold the control while adjusting the wheel to the desired position, then release the control to lock the steering wheel in position.

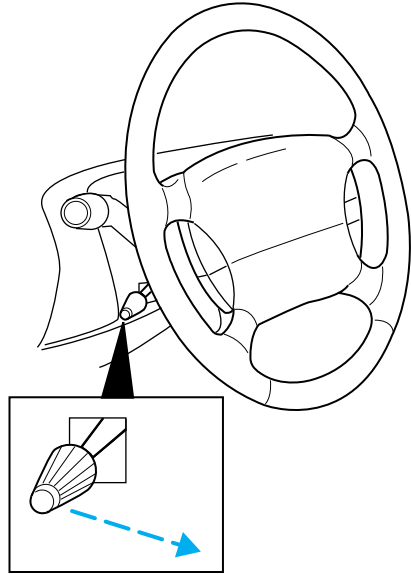

Never adjust the steering wheel when the vehicle is moving.

### HAZARD FLASHER

For information on the hazard flasher control, refer to *Hazard flasher* in the *Roadside emergencies* chapter.

### WINDSHIELD WIPER/WASHER CONTROLS

Rotate the windshield wiper control to the desired interval, low or high speed position.

The bars of varying length are for intermittent wipers. When in this position rotate the control upward for fast intervals and downward for slow intervals.

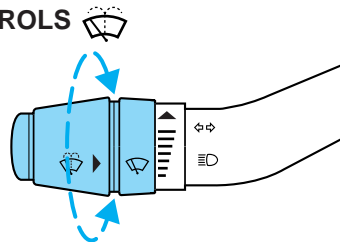

## Controls and features

Push (tap) the end of the stalk briefly for a single swipe (no wash). Push and hold for three swipes with wash. Push and hold for a longer wash (up to ten seconds).

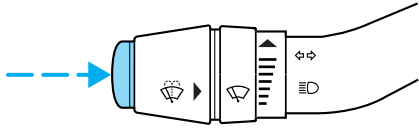

### Speed dependent wipers

When the windshield wiper control is set on the intermittent settings, speed-sensitive front wipers automatically adjust as the vehicle's speed changes.

### Rear window wiper and washer

For rear wiper operation, rotate the rear window wiper and washer control to the desired interval position.

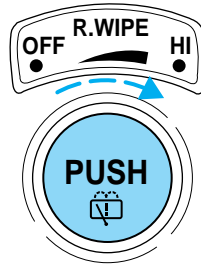

Press the control for rear washer fluid operation.

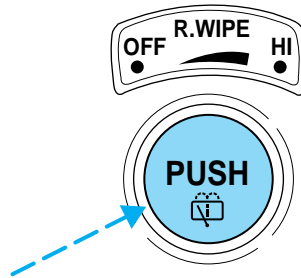

### STEERING WHEEL CONTROLS (IF EQUIPPED)

These controls allow you to operate some radio and climate control features.

## Controls and features

### Radio control features

- Press BAND/MODE to select AM, FM1, FM2, TAPE or CD (if equipped).

In Radio mode:

- Press MEM/NEXT to select a preset station from memory.

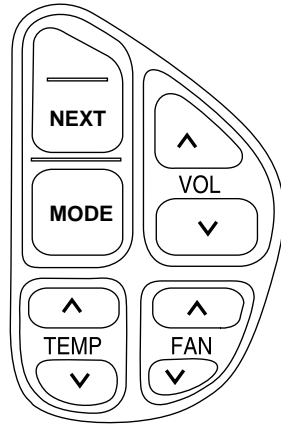

In Tape mode:

- Press MEM/NEXT to listen to the next selection on the tape.

In CD mode:

- Press MEM/NEXT to listen to the next track on the disc.

In any mode:

- Press VOL up or down to adjust the volume.

### Climate control features

- Press TEMP up or down to adjust temperature.
- Press FAN up or down to adjust fan speed.

## Controls and features

### OVERHEAD CONSOLE (IF EQUIPPED)

The appearance of your vehicle's overhead console will vary according to your option package.

#### Storage compartment (if equipped)

Press the OPEN control to open the storage compartment. The door will open slightly and can be moved to full open.

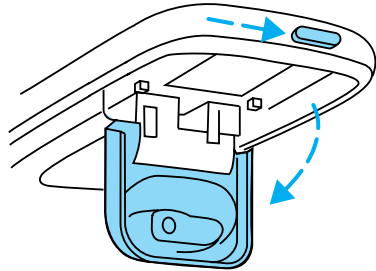

#### Installing a garage door opener (if equipped)

The storage compartment can be converted to accommodate a variety of aftermarket garage door openers:

- Remove the storage clip from the door.
- Place Velcro<sup>®</sup> hook onto side of aftermarket transmitter opposite of actuator control.
- Place the transmitter into storage compartment, control down.

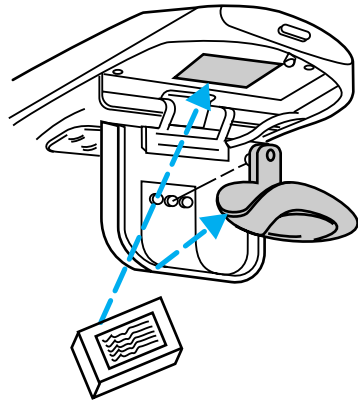

## Controls and features

- Place the provided height adaptors onto the back of the GARAGE control as needed.
- Press the GARAGE control to activate the transmitter.

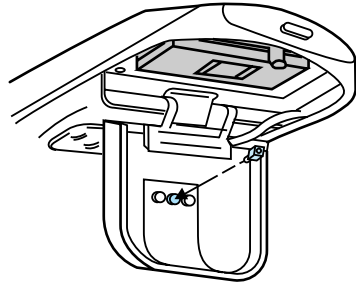

### Moon roof (if equipped)

You can move the moon roof back to open the glass panel or tilt up to ventilate the vehicle.

To open the moon roof:

The moon roof is equipped with an automatic, one-touch, express opening feature. Press and release the rear portion of the control. To stop motion at any time during the one-touch opening, press the control a second time.

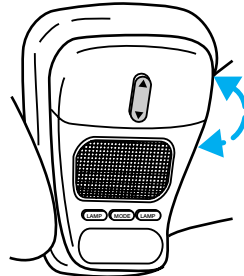

To close the moon roof:

Press and hold the front portion of the control until the glass panel stops moving. Once fully closed, the rear of the glass panel will appear higher than the front edge.

To vent:

To tilt the moon roof into the vent position (when the glass panel is closed), press and hold the front portion of the control. To close the moon roof from the vent position, press and hold the rear portion of the control until the glass panel stops moving.

If the battery is disconnected, discharged, or a new battery is installed, the moon roof needs to be opened to the vent position to reset the moon roof positions.

The moon roof has a sliding shade that can be opened or closed when the glass panel is shut. To close the shade, pull it toward the front of the vehicle.

## Controls and features



Do not let children play with the moon roof. They may seriously hurt themselves.

### Electronic compass/temperature display (if equipped)

#### Outside air temperature

The outside temperature display is contained in the overhead console.

The temperature display can be turned off and on by pressing the MODE control on the overhead console. The temperature can be displayed in Centigrade or Fahrenheit by pressing the MODE control.

If the outside temperature falls below 3.3°C (38°F), the display will alternate from “ICE” to the outside temperature at a two second rate for one minute.

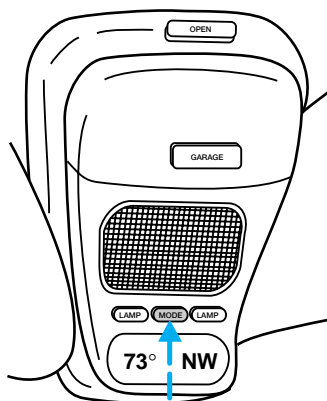

#### Compass

The compass display is contained in the overhead console. The vehicle heading is displayed as one of N, NE, E, SE, S, SW, W and NW.

The compass reading may be affected when you drive near large buildings, bridges, power lines and powerful broadcast antenna. Magnetic or metallic objects placed in or on the vehicle may also affect compass accuracy. Adjustments may need to be made to the zone and calibration of the compass.

## Controls and features

### **Compass zone adjustment**

1. Determine which magnetic zone you are in by referring to the zone map.

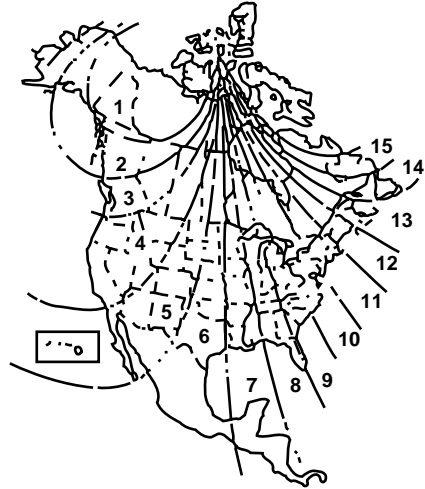

2. Turn ignition to the ON position.

3. Press and hold the MODE control until VAR appears in the display, then release. The display should show the current zone number.

4. Press the MODE control until the desired zone number appears. The display will flash and then return to normal operation. The zone is now updated.

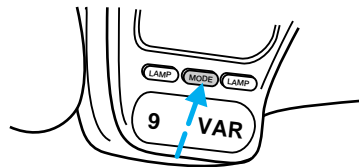

## Controls and features

### **Compass calibration adjustment**

Perform this adjustment in an open area free from steel structures and high voltage lines:

- Press and hold the MODE control until CAL appears in the display (approximately eight seconds) and release.
- Drive the vehicle slowly (less than 5 km/h [3 mph]) in circles until CAL indicator turns off in about 2–3 complete circles.

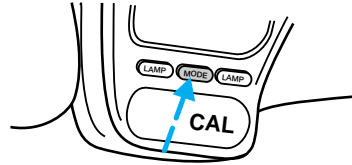

### **HOMELINK® UNIVERSAL TRANSCEIVER WITH TRAVELNOTE® (IF EQUIPPED)**

The HomeLink® Universal Transceiver, located on the driver's visor, provides a convenient way to replace up to three hand-held transmitters with a single built-in device. This feature will learn the radio frequency codes of most current transmitters to operate garage doors, entry gates, security systems, entry door locks, and home or office lighting.



When programming your HomeLink® Universal Transceiver, to a garage door or gate be sure that people and objects are out of the way to prevent potential harm or damage.

Do not use the HomeLink® Universal Transceiver with any garage door opener that lacks safety stop and reverse features as required by U.S. federal safety standards (this includes any garage door opener model manufactured before April 1, 1982). A garage door which cannot detect an object, signaling the door to stop and reverse, does not meet current U.S. federal safety standards. For more information on this matter, call toll-free: 1-800-355-3515 or on the Internet at **HomeLink.jci.com**.



## Controls and features

### Programming

1. Prepare for programming the HomeLink® Universal Transceiver by erasing the three factory default codes by holding down the two outside buttons until the red light begins to flash after 20 seconds. Release both buttons.

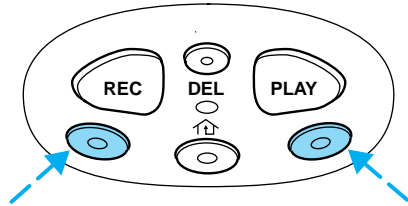

2. Hold the end of your hand-held transmitter 5–14 cm (2–5 inches) away from the HomeLink® Universal Transceiver surface (located on your visor) while keeping the red light in view.

3. Using both hands simultaneously press and hold the hand-held transmitter button and the desired HomeLink® button. Do not release the buttons until step 4 has been completed.

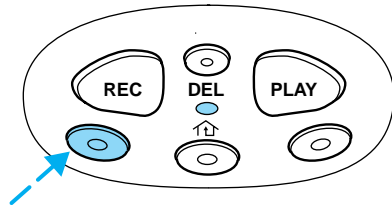

Some entry gates and garage door openers may require you to replace step 3 with the procedure in the “Canadian Programming” section.

4. The red light will flash slowly and then rapidly. Release both buttons when the red light flashes rapidly.

5. Follow steps 2 through 4 to program the remaining two buttons.

If you do not successfully program the HomeLink® Universal Transceiver after repeated attempts, refer to *Rolling code programming* which follows, or call toll-free customer assistance: 1-800-355-3515 or on the Internet at **HomeLink.jci.com**.

### Canadian Programming

During programming, your hand-held transmitter may automatically stop transmitting after two seconds which may not be long enough to program the HomeLink® Universal Transceiver.

## Controls and features

To program your hand-held transmitters:

- continue to hold the button on the HomeLink® Universal Transceiver.
- press and re-press the hand-held transmitter button every two seconds until the red light changes from a slow to a fast flash.

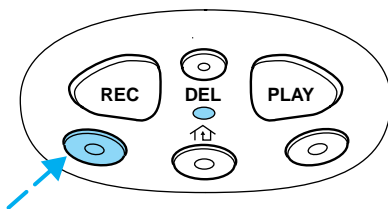

### Operating the HomeLink® Universal Transceiver

Once programmed, the HomeLink® Universal Transceiver can be used in place of hand-held transmitters. To operate, simply press and release the appropriate HomeLink® button (the red light will illuminate, indicating the signal is being transmitted).

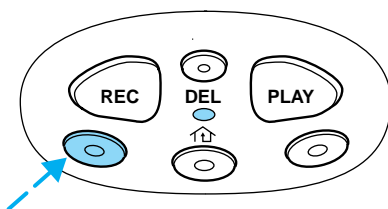

### Rolling code programming

Rolling code garage door openers (or other rolling code devices) which are “code protected” and manufactured after 1996, may be determined by the following:

- Reference the device owner’s manual for verification
- The hand-held transmitter appears to program the HomeLink® Universal Transceiver but does not activate the device.
- Press and hold the trained HomeLink® button. The device has the rolling code feature if the indicator light flashes rapidly and then turns solid after two seconds.

After completing the “Programming” functions, follow these steps to train a garage door opener with the rolling code feature:

1. Locate the **training button** on the garage door motor head unit. Refer to the garage door opener manual or call 1-800-355-3515 or on the Internet at **HomeLink.jci.com**. if there is difficulty locating the training button.
2. Press the training button on the garage door motor head unit (which will activate the **“training” light**).

## Controls and features

3. Press and release the programmed HomeLink® button. Press and release the HomeLink® button a *second time* to complete the training process. (Some garage door openers may require this procedure to be done a third time to complete the training).

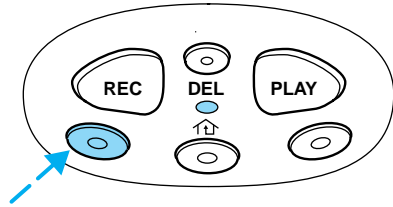

The 2nd or 3rd press from step 3 will activate the door. The HomeLink® Universal Transceiver has now been trained to the receiver. The remaining two buttons may now be programmed if this has not previously been done.

### Erasing HomeLink® buttons

Individual buttons cannot be erased, however, to erase the three programmed buttons:

1. Hold down the two outside buttons until the red light begins to flash after 20 seconds.
2. Release both buttons.

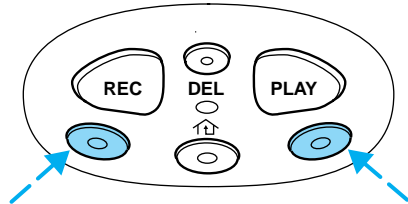

### Reprogramming a single HomeLink® button

To program a device to HomeLink® using a HomeLink® button previously trained, follow these steps:

1. Press and hold the desired HomeLink® button. **Do NOT** release until **step 4** has been completed.
2. When the indicator light begins to flash slowly (after 20 seconds), position the hand-held transmitter 5–14 cm (2 to 5 inches) away from the HomeLink® surface.
3. Press and hold the hand-held transmitter button.
4. The HomeLink® indicator light will flash, first slowly and then rapidly. When the indicator light begins to flash rapidly, release both buttons.

The previous device has now been erased and the new device can be activated by pushing the HomeLink® button that has just been programmed.

## Controls and features

### Operating TravelNote®

TravelNote® records and stores messages for up to three minutes in total length with simple controls. When you get an idea or remember something important while you're driving, you don't have to try to scribble it down or pull off the side of the road. All you have to do is push a button and begin speaking.

To record a message:

1. Press and release the **REC** button *one time* to start recording. (An audible tone will sound, confirming the onset of recording).
2. Press and release the **REC** button *a second time* to end recording. (An audible tone will sound again, confirming the end of recording and the red indicator light will turn off.)
3. While a message is being recorded, the indicator light will be a solid red.

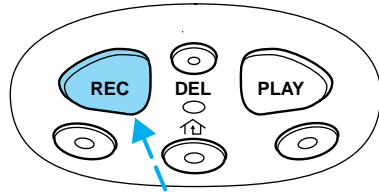

4. If the message exceeds the available memory space, two tones will sound, the indicator light will flash amber and recording will end.

The indicator light will flash amber and an “error” tone will sound if the **REC** button is pressed when memory is full.

To play a message:

1. Press and release the **PLAY** button to play the message.
2. Press and hold the **PLAY** button to hear all the messages in consecutive order starting with the most recent.
3. If the **PLAY** button is pressed while a message is being listened to, TravelNote will skip to the beginning of the next message.
4. During all **PLAY** functions, the indicator light will be a solid green.

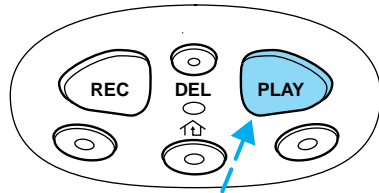

The indicator light will flash amber and an “error” tone will sound if the **PLAY** button is pressed but no message is currently in memory.

## Controls and features

To delete a message:

1. Press and release the **DEL** button while listening to a message or shortly after. The indicator light will flash green twice.

2. To delete all recorded messages, simultaneously press and release the

**PLAY** and **REC** buttons at the same time. The indicator light will flash green twice.

If the **DEL** button is inadvertently pressed or the time allotted (five seconds) has passed, the indicator light will flash amber and an “error” tone will sound.

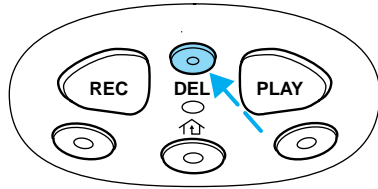

### AUTOLAMP DELAY SYSTEM (IF EQUIPPED)

The autolamp sets the headlamps to turn on and off automatically. The autolamp may be set to:

- turn on the lamps automatically at night
- turn off the lamps automatically during daylight
- keep the lamps on for up to three minutes after the key is turned to OFF

### Setting autolamp

1. Make sure the headlamp control is in the OFF position. Leaving the headlamp control on will override the autolamp.

2. Turn the ignition to the ON position or start the vehicle.

3. Slide the delay control all the way to the left.

The further you move the knob to the right, the longer the headlamps stay on after the ignition is turned to the OFF position. The autolamp will keep the headlamps on for a maximum of three minutes after the ignition is turned to OFF.

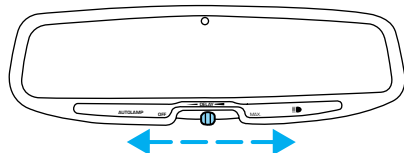
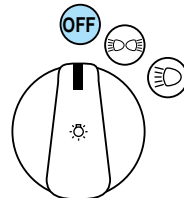

## Controls and features

4. The autolamp automatically turns the lamps on and off. The indicator light will illuminate when the headlamps turn on.

### AUTOMATIC DIMMING REAR VIEW MIRROR

The autolamp/automatic dimming mirror is equipped with an automatic dimming feature. This feature will change from the normal state to the non-glare “active” state when bright lights (glare) reach the mirror. When the mirror detects bright light from front or behind, it will adjust automatically to minimize glare.

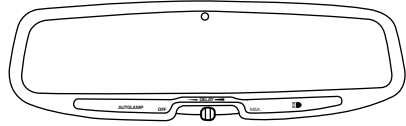

The mirror will automatically return to the normal position whenever the vehicle is placed in R (Reverse) (when the mirror is in the ON position). This helps to ensure a bright clear view in the mirror when backing up.

### POWER WINDOWS (IF EQUIPPED)

Press and hold the rocker switches to open and close windows.

- Press the top portion of the rocker switch to close.

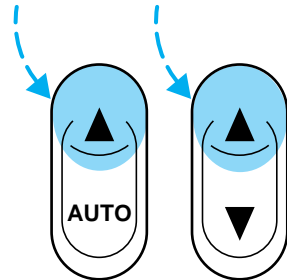

- Press the bottom portion of the rocker switch to open.

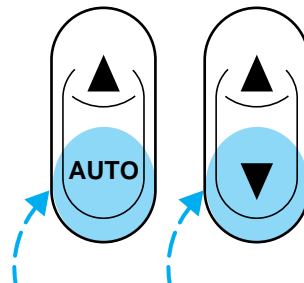

## Controls and features

### One touch down

- Press AUTO completely down and release quickly. The driver's window will open fully. Depress again to stop window operation.

One touch down can be deactivated during operation by pushing down on the top part of the driver power window control.

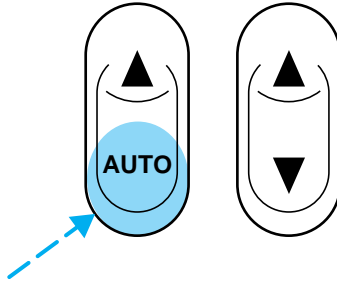

### Window lock

The window lock feature allows only the driver to operate the power windows.

To lock out all the window controls except for the driver's press the left side of the control. Press the right side to restore the window controls.

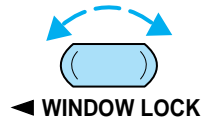

### POWER DOOR LOCKS (IF EQUIPPED)

Press U to unlock all doors and L to lock all doors.

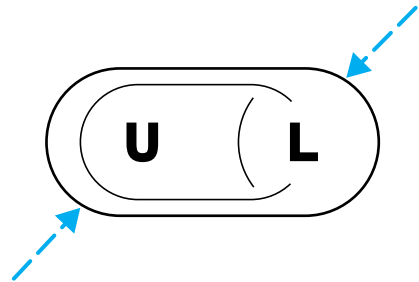

## Controls and features

### CHILDPROOF DOOR LOCKS

When these locks are set, the rear doors cannot be opened from the inside. The rear doors can be opened from the outside when the doors are unlocked.

The childproof locks are located on rear edge of each rear door and must be set separately for each door. Setting the lock for one door will not automatically set the lock for both doors.

Move lock control up to engage the childproof lock. Move control down to disengage childproof locks.

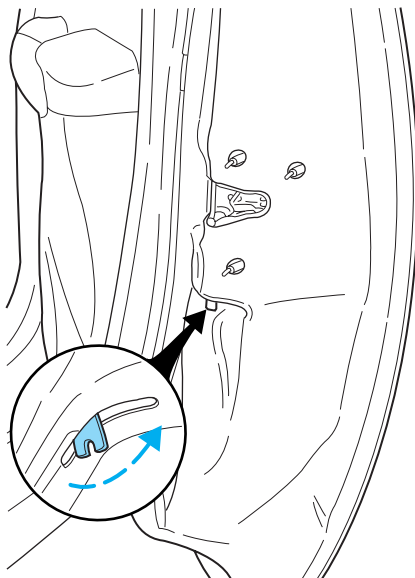

### POWER SIDE VIEW MIRRORS

To adjust your mirrors:

1. Select ◀ to adjust the left mirror or ▶ to adjust the right mirror.
2. Move the control in the direction you wish to tilt the mirror.

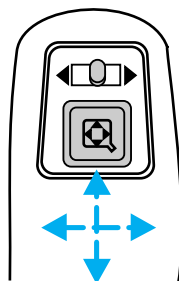

3. Return to the center position to lock mirrors in place.



## Controls and features

### Heated outside mirrors (if equipped)

Both mirrors are heated automatically to remove ice, mist and fog when the rear window defrost is activated.

Do not remove ice from the mirrors with a scraper or attempt to readjust the mirror glass if it is frozen in place. These actions could cause damage to the glass and mirrors.

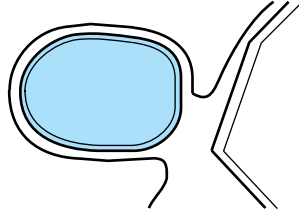

### Fold-away mirrors

Pull the side mirrors in carefully when driving through a narrow space, like an automatic car wash.

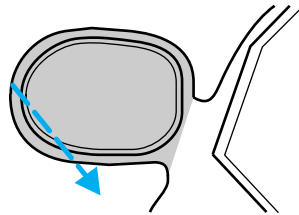

## CENTER CONSOLE

Your vehicle may be equipped with a variety of console features. These include:

- Utility compartment with cassette/compact disc storage
- Auxiliary power point
- Cupholders
- Tissue box holder
- Ashcup
- Compact disc changer (if equipped)
- Removable utility bag (if equipped)

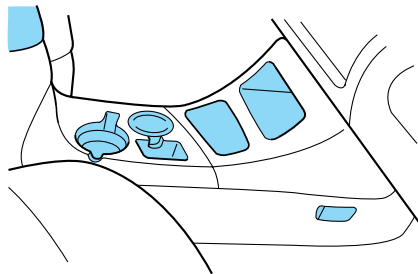

## Controls and features



Use only soft cups in the cupholder. Hard objects can injure you in a collision.

### Auxiliary power point 12V

The power point is an additional power source for electrical accessories.

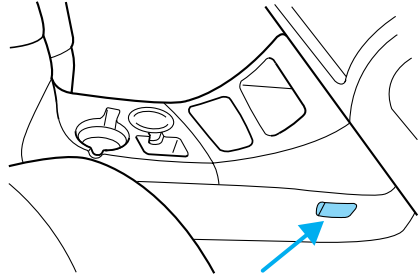

### Rear console features

The rear console incorporates the following features:

- air vents
- audio system controls
- rear seat climate controls
- cupholders

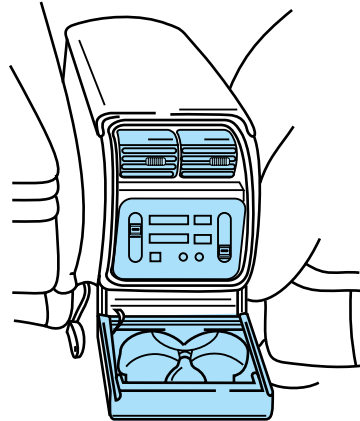

## Controls and features

### CENTER ARMREST/REAR CUPHOLDER (IF EQUIPPED)

Do not attempt to raise the console armrest when the rear cupholder is in use. If you find resistance when raising the armrest, make sure the cupholder is **fully** closed or else damage may occur to the armrest.

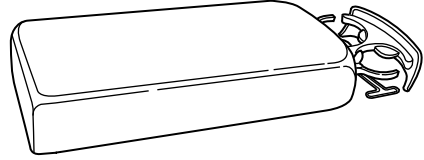

### POSITIVE RETENTION FLOOR MAT

Position the floor mat so that the eyelet is over the pointed end of the retention post and rotate forward to lock in. Make sure that the mat does not interfere with the operation of the accelerator or the brake pedal. To remove the floor mat, reverse the installation procedure.

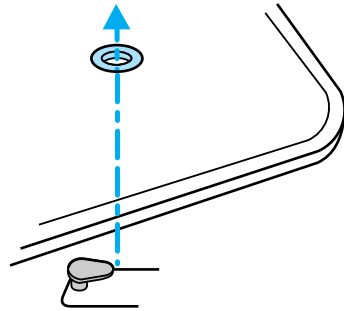

### REAR LIFTGATE

The liftgate area is only intended for cargo, not passengers. You can open and close the liftgate from outside the vehicle. It cannot be opened from inside the cargo area.

- To open the liftgate window, unlock the liftgate (with the key or power door locks) and push the key lock cylinder.
- To open the liftgate, unlock the liftgate and pull up on the handle under the license plate lamp shield.

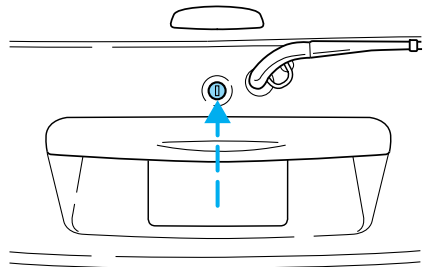

To lock the liftgate and the liftgate window, use the key or the power door locks, depress the key lock cylinder or press the door lock switch on the left side of the cargo area.

## Controls and features

The liftgate door and window should be closed before driving your vehicle. If not, possible damage may occur to the liftgate door lift cylinders and attaching hardware.

 Make sure that the liftgate door and/or window are closed to prevent exhaust fumes from being drawn into the vehicle. This will also prevent passengers and cargo from falling out. If you must drive with the liftgate door or window open, keep the vents open so outside air comes into the vehicle.

### CARGO COVER (IF EQUIPPED)

Your vehicle may be equipped with a cargo area shade that covers the luggage compartment of your vehicle.

To install the shade:

1. Fasten the cover into the mounting brackets (make sure the cover is right side up).
2. Pull the end of the shade toward you and hook the sides into the notches (right side first) in the rear trim panels.

 To prevent the possibility of injuries, the fasteners for the cargo area cover must be properly attached to the mounting clips on the rear trim panels.

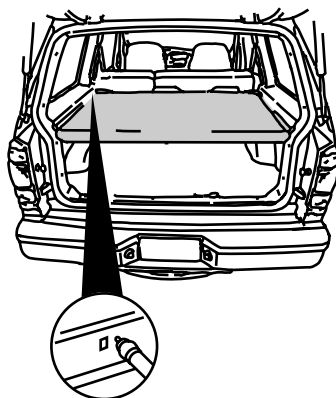

 Do not place any objects on the cargo area cover. They may obstruct your vision or strike occupants of the vehicle in the case of a sudden stop or collision.

### Rewinding the shade

With extended use, the cargo shade may lose its spring tension. If this occurs, the shade must be manually rewound. This is a two-person operation.

## Controls and features

1. Remove the shade from the vehicle and extend it with the smooth grain facing you.
2. Wrap the vinyl around the roller tube twice. Tuck the edges of the vinyl inside the end cap with each wrap.
3. Fold the edges of the vinyl towards the center, making sure that the edges clear the end cap slots. Use tape or a rubber band to hold the vinyl to the left side of the tube.
4. Push in the right end cap (marked RH) about  $\frac{1}{4}$  of the total length to disengage the clutch and hold the end cap in while turning the roller tube toward you 14 times.
5. Let go of the right end cap. The clutch will now engage and stop the shade from losing its spring tension.
6. Unfold the vinyl and place it into the end cap slots.
7. Insert the shade into the side mounting brackets and check to make sure that it operates properly.

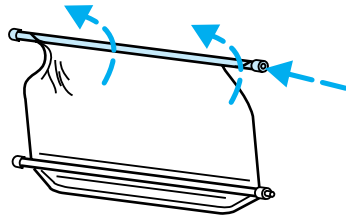
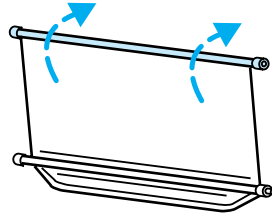

The cover may cause injury in a sudden stop or accident if it is not securely installed.

### REMOTE ENTRY SYSTEM (IF EQUIPPED)

The remote entry system allows you to lock or unlock all vehicle doors without a key.

The remote entry features only operate with the ignition in the LOCK position.

If there is any potential remote keyless entry problem with your vehicle, ensure **ALL key fobs** (remote entry transmitters) are brought to the dealership, to aid in troubleshooting.

## Controls and features

### Unlocking the doors

Press this control to unlock the driver's door. The interior lamps will illuminate.

Press the control a second time within five seconds to unlock all doors.

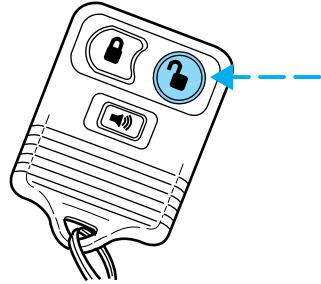

### Locking the doors

Press this control to lock all doors.

To confirm all doors are closed and locked, press the control a second time within five seconds. The doors will lock again, the horn will chirp and the lamps will flash.

If any of the doors are ajar, the horn will make two quick chirps, reminding you to properly close all doors.

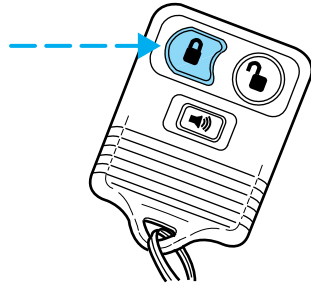

### Sounding a panic alarm

Press this control to activate the alarm.

To deactivate the alarm, press the control again or turn the ignition to ACC or ON.

This device complies with part 15 of the FCC rules and with RS-210 of Industry Canada. Operation is subject to the following two conditions: (1) This device may not cause harmful interference, and (2) This device must accept any interference received, including interference that may cause undesired operation.

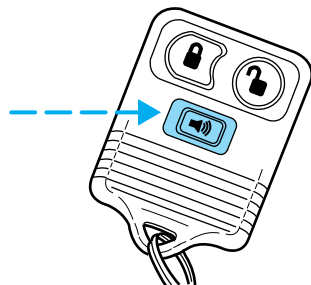

## Controls and features

**Changes or modifications not expressly approved by the party responsible for compliance could void the user's authority to operate the equipment.**

### Memory seat feature (if equipped)

The remote entry system can also control the memory seat feature.

Press the control once to unlock the driver's door and move the memory seat feature to the corresponding memory position, just as if you had pressed the memory control in the vehicle.

When your dealer programs new transmitters:

- the first transmitter programmed will recall memory position one.
- the second transmitter programmed will recall memory position two.
- the third transmitter programmed will recall memory position three.
- the fourth transmitter programmed will not recall a memory position.

Memory positions can be changed at any time. The memory feature can be deactivated or reactivated by performing the following:

1. Make sure the ignition is off and all doors and the liftgate window are closed.
2. Turn the ignition key from OFF to ON.
3. Press the power door unlock control three times.
4. Turn the ignition key from ON to OFF.
5. Press the power door unlock control three times.
6. Turn the ignition back to ON. The horn will chirp.
7. Press the unlock control two times, then press the lock control. The horn will chirp twice if the remote memory seat feature was deactivated or will sound three times (two short chirps followed by one long chirp) if the feature was activated.
8. Turn the ignition to OFF. The horn will chirp once to confirm that you activated or deactivated the remote memory seat feature.

The memory feature will continue to work from the door control even when deactivated at the remote entry module.

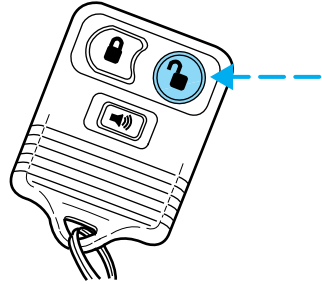

## Controls and features

### Replacing the battery

The transmitter is powered by one coin type three-volt lithium battery CR2032 or equivalent. Typical operating range will allow you to be up to 10 meters (33 feet) away from your vehicle. A decrease in operating range can be caused by:

- weather conditions
- nearby radio towers
- structures around the vehicle
- other vehicles parked next to the vehicle

To replace the battery:

1. Twist a thin coin between the two halves of the transmitter near the key ring. **DO NOT TAKE THE FRONT PART OF THE TRANSMITTER APART.**
2. Place the positive (+) side of new battery in the same orientation. Refer to the diagram inside the transmitter unit.
3. Snap the two halves back together.

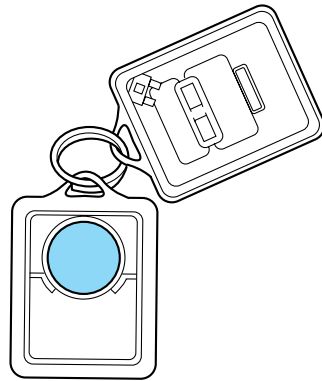

### Replacing lost transmitters

If a remote transmitter has been lost and you would like to remove it from the vehicle's memory, or you would like to purchase additional remote transmitters and have them programmed to your vehicle:

- Take **all** your vehicle's transmitters to your dealer for programming, or
- Perform the programming procedure yourself

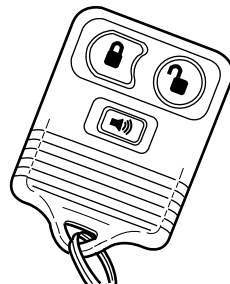



## Controls and features

### Programming remote transmitters

It is necessary to have **all** (maximum of four — original and/or new) of your remote transmitters available prior to beginning this procedure.

To program the transmitters yourself:

- Place the key in the ignition and turn from 2 (LOCK) to 3 (OFF) and cycle between 3 (OFF) and 4 (ON) eight times in rapid succession (within 10 seconds) with the eighth turn ending in the 4 (ON) position. The doors will lock/unlock to confirm that programming mode has been entered.
- Within 20 seconds, program a remote transmitter by pressing any button on a transmitter. The doors will lock/unlock to confirm that the remote transmitter has been programmed. (If more than 20 seconds pass before pressing a remote transmitter button, the programming mode will exit and the procedure will have to be repeated.)
- Repeat the previous step to program additional remote transmitters. The doors will lock/unlock to confirm that each remote transmitter has been programmed.
- When you have completed programming the remote transmitters, turn the ignition to 3 (OFF). Again the doors will lock/unlock to confirm programming has been completed.

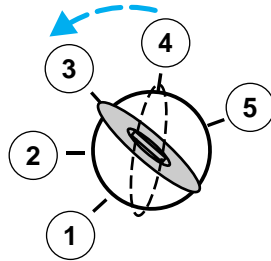

### Illuminated entry

The interior lamps illuminate when the remote entry system is used to unlock the door(s) or sound the personal alarm.

The system automatically turns off after 25 seconds or when the ignition is turned to the RUN or ACC position. The dome lamp control (if equipped) must **not** be set to the OFF position for the illuminated entry system to operate.

## Controls and features

The inside lights will not turn off if:

- they have been turned on with the dimmer control or
- any door is open.

The battery saver will shut off the interior lamps 45 minutes after the ignition has been turned to the OFF position.

### Keyless entry system (if equipped)

With the keyless entry keypad, you can:

- lock or unlock the vehicle doors without using the key
- activate/deactivate the autolock feature

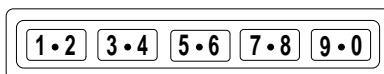

See also *Remote entry system* in this chapter for more information.

Your vehicle has a factory-set 5-digit code that operates the keyless entry system. You can also program your own 5-digit personal entry code.

The factory-set code is located:

- on the owner's wallet card in the glove compartment
- taped to the computer module
- or at your dealer

When pressing the controls on the keyless entry keypad, press the middle of the controls to ensure a good activation.

### Programming your own personal entry code

1. Enter the factory-set code (keypad will illuminate when pressed).
2. Press the 1/2 control within five seconds of step 1.
3. Enter your personal 5 digit code. Enter each digit within five seconds of the previous one.

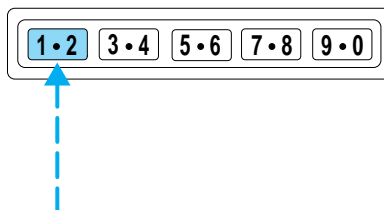

Do not set a code that includes five of the same number or presents them in sequential order. Thieves can easily figure out these types of codes.

## Controls and features

Your personal code does not replace the permanent code that the dealership gave you. You can use either code to unlock your vehicle. If a second personal code is entered, the module will erase the first personal code in favor of the new code.

If you wish to erase your personal code, use the following instructions:

### ***Erasing personal code***

1. Enter the factory-set code.
2. Press 1/2 within five seconds of step 1.
3. Press the 7/8 and 9/0 controls at the same time within five seconds of step 2.

The system will now only respond to the factory-set code.

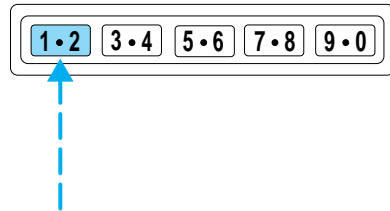

### ***Unlocking the doors with the keyless entry system***

To unlock the driver's door, enter either the factory-set code or personal code (each digit pressed within five seconds of the prior digit). The interior lamps will illuminate.

To unlock all doors, enter the factory-set code or personal code (driver door unlocks) and press the 3/4 control within five seconds.

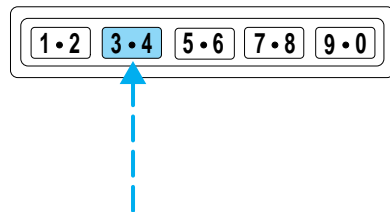

### ***Locking the doors with the keyless entry system***

To lock all the doors, press 7/8 and 9/0 at the same time. It is not necessary to first enter the keypad code.

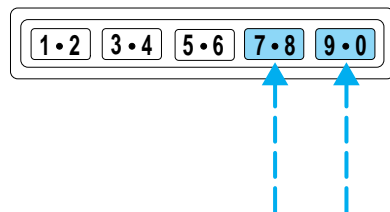

## Controls and features

### **Autolock**

The autolock feature will lock all of the vehicle doors when:

- all doors are closed
- the engine is running and
- you shift into any gear putting the vehicle in motion

The autolock feature repeats when:

- any door, except the drivers door, is opened then closed while the engine is running and
- you put the vehicle in motion

### **Deactivating autolock**

Before following the activation or deactivation procedures, make sure that the ignition is OFF and all vehicle doors and liftgate window are closed.

1. Enter the 5 digit entry code.
2. Press and release the 3/4 control while holding the 7/8 control.
3. Release the 7/8 control.

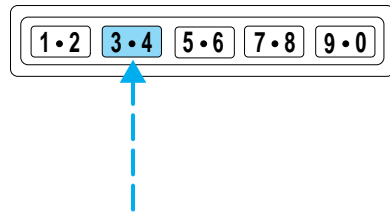

The horn will chirp once if autolock was deactivated or twice (one short and one long chirp) if autolock was activated.

To reactivate autolock, repeat steps 1 through 3.

Autolock can also be activated or deactivated using the following procedure:

You must complete steps 1 through 5 within 30 seconds or the procedure will have to be repeated. If the procedure needs to be repeated, you must wait 30 seconds.

1. Turn the ignition key from OFF to ON/ACC.
2. Press the power door UNLOCK control three times.
3. Turn the ignition key from ON/ACC to OFF.
4. Press the power door UNLOCK control three times.
5. Turn the ignition key from OFF to ON/ACC. A horn chirp indicates the enable/disable feature is entered.

## Controls and features

6. Press the power door UNLOCK control one time.
7. Press the power door LOCK control to toggle the Autolock/Relock state. You will receive a horn chirp followed by either a long honk, autolock/relock is enabled, or no honk, autolock/relock is disabled.
8. Turn ignition to OFF.

If autolock/relock has been changed, the horn will chirp to confirm procedure is complete.

### SECURILOCK™ PASSIVE ANTI-THEFT SYSTEM

SecuriLock™ passive anti-theft system is an engine immobilization system. This system prevents the engine from being started unless a **coded key** is used.

The SecuriLock™ passive anti-theft system is not compatible with non-Ford aftermarket remote start systems. Use of these systems may result in vehicle starting problems and a loss of security protection.

#### Automatic arming

The vehicle is armed immediately after switching the ignition to the 3 (OFF) position. The **THEFT** light in the instrument cluster will flash every two seconds when the vehicle is armed.

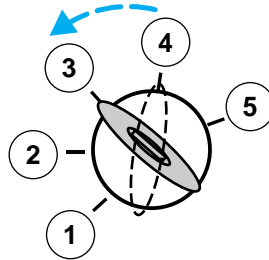

#### Automatic disarming

Switching the ignition to the 4 (ON) position with a **coded key** disarms the vehicle. The **THEFT** light will illuminate for three seconds and then go out. If the **THEFT** light stays on for an extended period of time or flashes rapidly, have the system serviced by your dealership or a qualified technician.

## Controls and features

### Key information

Your vehicle is supplied with **two coded keys**. Only a **coded key** will start your vehicle. Spare coded keys can be purchased from your dealership. Your dealership can program your key or you can “do it yourself”, refer to *Programming spare keys*.

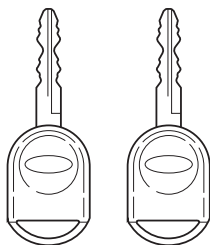

The SecuriLock<sup>™</sup> passive anti-theft system is not compatible with non-Ford (aftermarket) remote start systems. Use of these systems may result in vehicle starting problems and a loss of security protection. Large metallic objects, electronic devices on the key chain that can be used to purchase gasoline or similar items, or a second key on the same key ring as the PATS ignition key may cause vehicle starting concern. If present, you need to keep these objects from touching the PATS ignition key while starting the engine. These objects and devices cannot damage the PATS ignition key, but can cause a

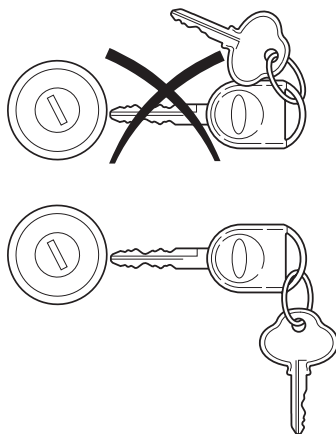

momentary concern if they are too close to the key during engine start. If a problem occurs, turn ignition OFF and restart the engine with all other objects on the key ring held away from the ignition key. Check to make sure the encoded ignition key is an approved Ford encoded ignition key.

If your keys are lost or stolen you will need to do the following:

- Use your spare key to start the vehicle. or
- Have your vehicle towed to a dealership or locksmith. The key codes will need to be erased from your vehicle and new key codes will need to be re-coded.

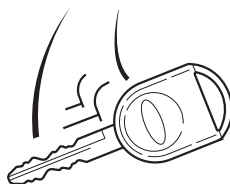

## Controls and features

Replacing coded keys can be very costly and you may want to store an extra programmed key away from the vehicle in a safe place to prevent an unforeseen inconvenience.

The correct PATS key must be used for your vehicle. The use of the wrong type of PATS key may lead to a “NO-START” condition. Refer to the Rotunda Key Application Matrix for the correct PATS key type for your particular vehicle make and model year. If a key Application Matrix is not available, call 1-800-ROTUNDA (1-800-768-8632) (press 2) to order a Key Application Matrix.



If an unprogrammed key is used in the ignition it will cause a “**NO START**” condition.

### Programming spare keys

A maximum of eight keys can be coded to your vehicle. Only SecuriLock<sup>™</sup> keys can be used. To program a **coded key** yourself, you will need two previously programmed **coded keys** (keys that already operate your vehicle’s engine) and the new unprogrammed key(s) readily accessible for timely implementation of each step in the procedure.

If two previously programmed coded keys are not available (one or both of your original keys were lost or stolen), you must bring your vehicle to your dealership to have the spare coded key(s) programmed.

Please read and understand the entire procedure before you begin.

1. Insert the first previously programmed **coded key** into the ignition and turn the ignition from 3 (OFF) to 4 (ON) (maintain ignition in 4 (ON) for at least one second).

2. Turn ignition to 3 (OFF) then 2 (LOCK) and remove the first **coded key** from the ignition.

3. Within ten seconds of removing the first **coded key**, insert the second previously programmed **coded key** into the ignition and turn the ignition from 3 (OFF) to 4 (ON) (maintain ignition in 4 (ON) for at least one second but no more than ten seconds).

4. Turn the ignition to 3 (OFF) then 2 (LOCK) and remove the second **coded key** from the ignition.

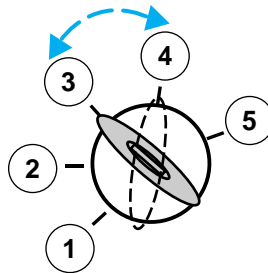

## Controls and features

5. Within 20 seconds of removing the second **coded key**, insert the new unprogrammed key (new key/valet key) into the ignition and turn the ignition from 3 (OFF) to 4 (ON) (maintain ignition in 4 (ON) for at least one second). This step will program your new key to a coded key.

6. To program additional new unprogrammed key(s), repeat this procedure from step 1.

If successful, the new coded key(s) will start the vehicle's engine and the theft indicator will illuminate for three seconds and then go out.

If not successful, the new coded key(s) will not start the vehicle's engine and the theft indicator will flash on and off. If failure repeats, bring your vehicle to your dealership to have the new spare key(s) programmed.



## Seating and safety restraints

### SEATING

#### Adjustable head restraints (if equipped)

Your vehicle's seats may be equipped with head restraints which are vertically adjustable. The purpose of these head restraints is to help limit head motion in the event of a rear collision. To properly adjust your head restraints, lift the head restraint so that it is located directly behind your head or as close to that position as possible. Refer to the following to raise and lower the head restraints.

The head restraints can be moved up and down.

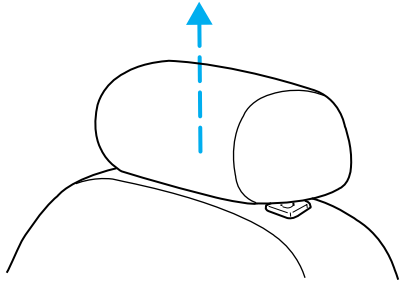

Push control to lower head restraint.

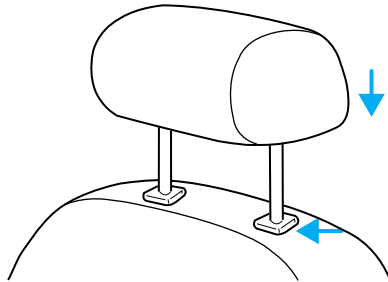

## Seating and safety restraints

### Adjusting the front manual seat



Never adjust the driver's seat or seatback when the vehicle is moving.



Do not pile cargo higher than the seatbacks to reduce the risk of injuring people in a collision or sudden stop.



Always drive and ride with your seatback upright and the lap belt snug and low across the hips.



Reclining the seatback can reduce the effectiveness of the seat's safety belt in the event of a collision.

Lift handle to move seat forward or backward.

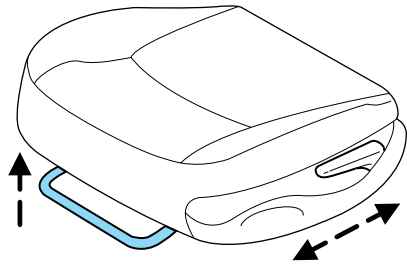

Pull lever up to adjust seatback.

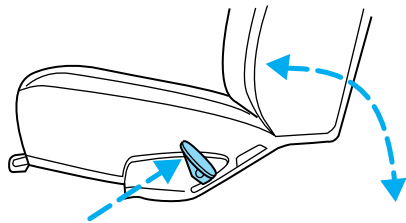

### Adjusting the front power seat (if equipped)



Never adjust the driver's seat or seatback when the vehicle is moving.

## Seating and safety restraints



Do not pile cargo higher than the seatbacks to avoid injuring people in a collision or sudden stop.



Always drive and ride with your seatback upright and the lap belt snug and low across the hips.



Reclining the seatback can reduce the effectiveness of the seat's safety belt in the event of a collision.

The control is located on the outboard side of the seat cushion.

Press front to raise or lower the front portion of the seat cushion.

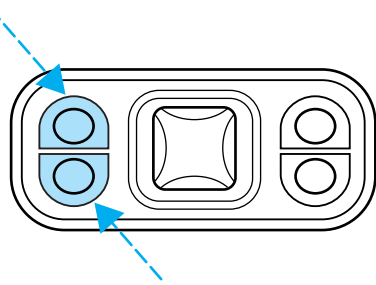

Press rear to raise or lower the rear portion of the seat cushion.

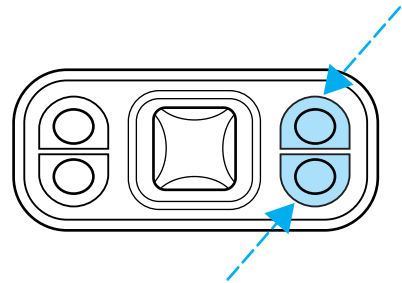

Press the control to move the seat forward, backward, up or down.

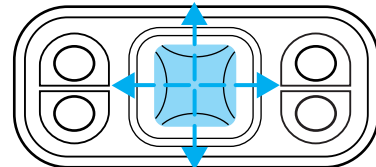

## Seating and safety restraints

### Memory seats (if equipped)

This system allows automatic positioning of the driver seat to three programmable positions.

The memory seat control is located on the driver door.

- To program position one, move the driver seat to the desired position using the seat controls. Press the SET control. The SET control indicator light will briefly illuminate. While the light is illuminated, press control 1.
- To program position two, repeat the previous procedure using control 2.
- To program position three, repeat the previous procedure but press controls 1 and 2 simultaneously.

A position can only be set or recalled when the transmission gearshift is in Park or Neutral. A memory seat position may be programmed at any time.

The memory seat positions are also recalled when you press your remote entry transmitter UNLOCK control.

To program the memory seat to remote entry transmitter, refer to *Remote entry system* in the *Controls and features* chapter.

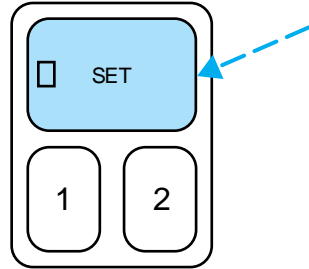

### Using the manual lumbar support

Turn the lumbar support control toward the front of vehicle to move the lumbar support forward for more direct support.

Turn the lumbar support control toward the rear of vehicle to move the lumbar support back for less direct support.

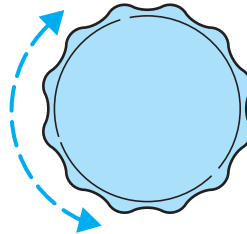

## Seating and safety restraints

### Using the power lumbar support (if equipped)

The power lumbar control is located on the outboard side of the seat.

Press one side of the control to adjust firmness.

Press the other side of the control to adjust softness.

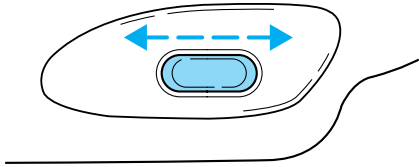

## REAR SEATS

### Head restraints

Your vehicle's seats may be equipped with head restraints which are vertically adjustable. The purpose of these head restraints is to help limit head motion in the event of a rear collision. To properly adjust your head restraints, lift the head restraint so that it is located directly behind your head or as close to that position as possible. Refer to the following to raise and lower the head restraints.

Push or pull the head rests to the desired position.

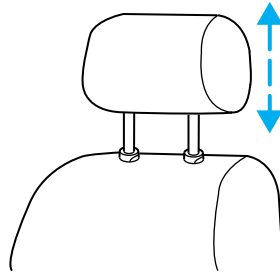

## Seating and safety restraints

### Folding rear seats (if equipped)

If the rear seat is equipped with adjustable head restraints, they should be placed in the full down position before folding the seat back down.

1. Press the lower release control downward to unlatch the seatback.
2. Rotate the seatback downward into the load floor position.
3. Press down on the top outboard area of the seatback until a click is heard. The seat is now latched in the floor position.

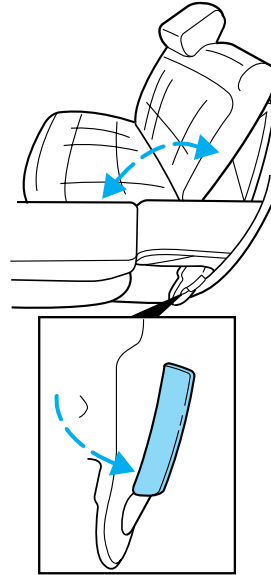

## Seating and safety restraints

To return the seat to the upright position:

- Press downward on the upper corner of the seatback and hold.
- Pull the release handle upward to unlatch the seat.
- Rotate the seatback upward until the seatback latches in the upright position. The seatback will click when it is locked into position.

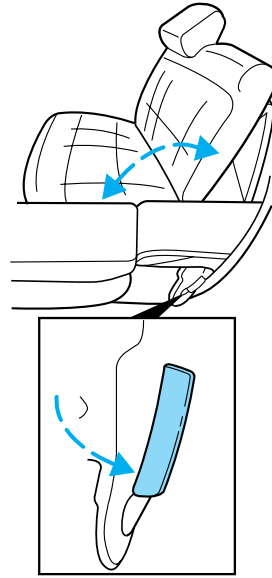

### SAFETY RESTRAINTS

#### Safety restraints precautions



Always drive and ride with your seatback upright and the lap belt snug and low across the hips.



To reduce the risk of injury, make sure children sit where they can be properly restrained.



Never let a passenger hold a child on his or her lap while the vehicle is moving. The passenger cannot protect the child from injury in a collision.

## Seating and safety restraints



All occupants of the vehicle, including the driver, should always properly wear their safety belts, even when an air bag SRS is provided.



It is extremely dangerous to ride in a cargo area, inside or outside of a vehicle. In a collision, people riding in these areas are more likely to be seriously injured or killed. Do not allow people to ride in any area of your vehicle that is not equipped with seats and safety belts. Be sure everyone in your vehicle is in a seat and using a safety belt properly.



In a rollover crash, an unbelted person is significantly more likely to die than a person wearing a safety belt.



Each seating position in your vehicle has a specific safety belt assembly which is made up of one buckle and one tongue that are designed to be used as a pair. 1) Use the shoulder belt on the outside shoulder only. Never wear the shoulder belt under the arm. 2) Never swing the safety belt around your neck over the inside shoulder. 3) Never use a single belt for more than one person.



Always transport children 12 years old and under in the back seat and always properly use appropriate child restraints.

### Energy Management Feature

- This vehicle has a safety belt system with an energy management feature at the front passenger seating position to help further reduce the risk of injury in the event of a head-on collision.
- This safety belt system has a retractor assembly that is designed to pay out webbing in a controlled manner. This feature is designed to help reduce the belt force acting on the occupant's chest.



## Seating and safety restraints

 After any vehicle collision, the safety belt system at all outboard seating positions (except driver, which has no “automatic locking retractor” feature) must be checked by a qualified technician to verify that the “automatic locking retractor” feature for child seats is still functioning properly. In addition, all safety belts should be checked for proper function.

 **BELT AND RETRACTOR ASSEMBLY MUST BE REPLACED** if the safety belt assembly “automatic locking retractor” feature or any other safety belt function is not operating properly when checked according to the procedures in Workshop Manual.

 Failure to replace the Belt and Retractor assembly could increase the risk of injury in collisions.

### Combination lap and shoulder belts

1. Insert the belt tongue into the proper buckle (the buckle closest to the direction the tongue is coming from) until you hear a snap and feel it latch. Make sure the tongue is securely fastened in the buckle.

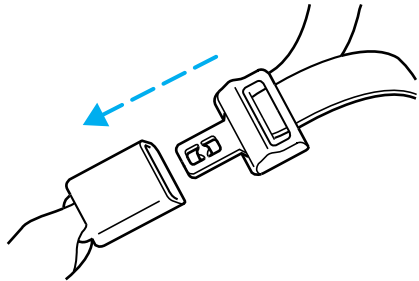

2. To unfasten, push the release button and remove the tongue from the buckle.

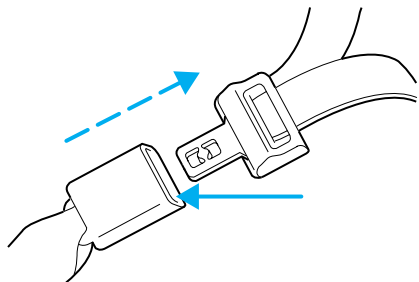

## Seating and safety restraints

The front and rear outboard safety restraints in the vehicle are combination lap and shoulder belts. The front passenger and rear seat outboard safety belts have two types of locking modes described below:

### Vehicle sensitive mode

The vehicle sensitive mode is the normal retractor mode, allowing free shoulder belt length adjustment to your movements and locking in response to vehicle movement. For example, if the driver brakes suddenly or turns a corner sharply, or the vehicle receives an impact of approximately 8 km/h (5 mph) or more, the combination safety belts will lock to help reduce forward movement of the driver and passengers.

### Automatic locking mode

In this mode, the shoulder belt is automatically pre-locked. The belt will still retract to remove any slack in the shoulder belt.

The automatic locking mode is not available on the driver safety belt.

### When to use the automatic locking mode

- **Anytime** a child safety seat is installed in a passenger front or outboard rear seating position (if equipped). Children 12 years old and under should be properly restrained in the rear seat whenever possible. Refer to *Safety Restraints for Children* or *Safety Seats for Children* later in this chapter.

### How to use the automatic locking mode

- Buckle the combination lap and shoulder belt.

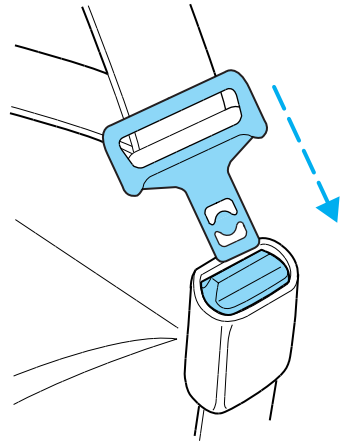

## Seating and safety restraints

- Grasp the shoulder portion and pull downward until the entire belt is extracted.



- Allow the belt to retract. As the belt retracts, you will hear a clicking sound. This indicates the safety belt is now in the automatic locking mode.

### ***How to disengage the automatic locking mode***

Disconnect the combination lap/shoulder belt and allow it to retract completely to disengage the automatic locking mode and activate the vehicle sensitive (emergency) locking mode.



After any vehicle collision, the front passenger outboard seat belt system must be checked by a qualified technician to verify that the “automatic locking retractor” feature for child seats is still functioning properly. In addition, all seat belts should be checked for proper function.



**BELT AND RETRACTOR ASSEMBLY MUST BE REPLACED** if the seat belt assembly “automatic locking retractor” feature or any other seat belt function is not operating properly when checked according to the procedures in Workshop Manual.



Failure to replace the Belt and Retractor assembly could increase the risk of injury in collisions.

## Seating and safety restraints

### Front safety belt height adjustment

Your vehicle has safety belt height adjustments for the driver and front passenger. Adjust the height of the shoulder belt so the belt rests across the middle of your shoulder.

To lower the shoulder belt height, push the button and slide the height adjuster down. To raise the height of the shoulder belt, slide the height adjuster up. Pull down on the height adjuster to make sure it is locked in place.

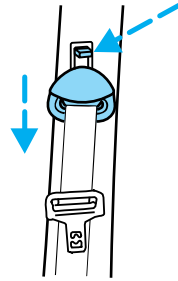

Position the shoulder belt height adjusters so that the belt rests across the middle of your shoulder. Failure to adjust the safety belt properly could reduce the effectiveness of the seat belt and increase the risk of injury in a collision.

### Safety belt extension assembly

If the safety belt assembly is too short for you, even when fully extended, 20 cm (8 inches) can be added to the safety belt assembly by adding a safety belt extension assembly (part number 611C22). Safety belt extension assemblies can be obtained from your dealer at no cost.

Use only extensions manufactured by the same supplier as the safety belt. Manufacturer identification is located at the end of the webbing on the label. Also, use the safety belt extension only if the safety belt is too short for you when fully extended. Do not use extensions to change the fit of the shoulder belt across the torso.

### Safety belt warning light and indicator chime

The seat belt warning light illuminates in the instrument cluster and a chime sounds to remind the occupants to fasten their safety belts.

## Seating and safety restraints

### Conditions of operation

If...	Then...
The driver's safety belt is not buckled before the ignition switch is turned to the ON position...	The safety belt warning light illuminates 1-2 minutes and the warning chime sounds 4-8 seconds.
The driver's safety belt is buckled while the indicator light is illuminated and the warning chime is sounding...	The safety belt warning light and warning chime turn off.
The driver's safety belt is buckled before the ignition switch is turned to the ON position...	The safety belt warning light and indicator chime remain off.

### Belt minder (if equipped)

The Belt Minder feature is a supplemental warning to the safety belt warning function. This feature provides additional reminders to the driver that the driver's safety belt is unbuckled by intermittently sounding a chime and illuminating the safety belt warning lamp in the instrument cluster.

If...	Then...
The driver's safety belt is not buckled before the vehicle has reached at least 5 km/h (3 mph) and 1-2 minutes have elapsed since the ignition switch has been turned to ON...	The Belt Minder feature is activated - the safety belt warning light illuminates and the warning chime sounds for 6 seconds every 30 seconds, repeating for approximately 5 minutes or until safety belt is buckled.
The driver's safety belt is buckled while the safety belt indicator light is illuminated and the safety belt warning chime is sounding...	The Belt Minder feature will not activate.
The driver's safety belt is buckled before the ignition switch is turned to the ON position...	The Belt Minder feature will not activate.

The purpose of the Belt Minder is to remind occasional wearers to wear safety belts all of the time.

## Seating and safety restraints

The following are reasons most often given for not wearing safety belts:  
(All statistics based on U.S. data)

Reasons given...	Consider...
"Crashes are rare events"	<b>36 700 crashes occur every day.</b> The more we drive, the more we are exposed to "rare" events, even for good drivers. <i>1 in 4 of us will be seriously injured in a crash during our lifetime.</i>
"I'm not going far"	<b>3 of 4</b> fatal crashes occur within <b>25</b> miles of home.
"Belts are uncomfortable"	Ford designs its safety belts to enhance comfort. If you are uncomfortable - try different positions for the safety belt upper anchorage and seatback which should be as upright as possible; this can improve comfort.
"I was in a hurry"	<b>Prime time for an accident.</b> Belt Minder reminds us to take a few seconds to buckle up.
"Seat belts don't work"	<b>Safety belts</b> , when used properly, <b>reduce risk of death</b> to front seat occupants by <b>45% in cars</b> , and by <b>60% in light trucks</b> .
"Traffic is light"	<b>Nearly 1 of 2 deaths occur in single-vehicle crashes</b> , many when no other vehicles are around.
"Belts wrinkle my clothes"	Possibly, but a serious crash can do much more than wrinkle your clothes, particularly if you are unbelted.
"The people I'm with don't wear belts"	Set the example, teen deaths occur 4 times more often in vehicles with TWO or MORE people. Children and younger brothers/sisters imitate behavior they see.
"I have an air bag"	Air bags offer greater protection when used with safety belts. Frontal airbags are not designed to inflate in rear and side crashes or rollovers.
"I'd rather be thrown clear"	Not a good idea. <b>People</b> who are <b>ejected are 40 times more likely to DIE</b> . Safety belts help prevent ejection, WE CAN'T "PICK OUR CRASH".

## Seating and safety restraints



Do not sit on top of a buckled safety belt to avoid the Belt Minder chime. Sitting on the safety belt will increase the risk of injury in an accident. To disable (one-time) or deactivate the Belt Minder feature please follow the directions stated below.

### **One time disable**

Anytime the safety belt is buckled and then unbuckled during an ignition ON cycle, Belt Minder will be disabled for that ignition cycle only.

### **Deactivating/activating the belt minder feature**

*Read steps 1 - 9 thoroughly before proceeding with the deactivation/activation programming procedure.*

The Belt Minder feature can be deactivated/activated by performing the following procedure:

Before following the procedure, make sure that:

- the parking brake is set
- the gearshift is in P (Park) (automatic transmission) or the neutral position (manual transmission).
- the ignition switch is in the OFF position
- all vehicle doors are closed
- the driver's safety belt is unbuckled
- the parklamps/headlamps are in OFF position (If vehicle is equipped with Autolamps, the Autolamps feature **MUST** be turned off.)



To reduce the risk of injury, do not deactivate/activate the Belt Minder feature while driving the vehicle.

1. Turn the ignition switch to the RUN (or ON) position. (DO NOT START THE ENGINE)
2. Wait until the safety belt warning light turns off. (Approximately 1–2 minutes)
  - Steps 3–5 must be completed within 60 seconds or the procedure will have to be repeated.
3. Buckle then unbuckle the safety belt three times, ending with the safety belt unbuckled. This can be done before or during Belt Minder warning activation.

## Seating and safety restraints

4. Turn on the parklamps/headlamps, turn off the parklamps/headlamps.
5. Buckle then unbuckle the safety belt three times, ending with the safety belt unbuckled.
  - After step 5 the safety belt warning light will be turned on for three seconds.
6. Within seven seconds of the safety belt warning light turning off, buckle then unbuckle the safety belt.
  - This will disable Belt Minder if it is currently enabled, or enable Belt Minder if it is currently disabled.
7. Confirmation of disabling Belt Minder is provided by flashing the safety belt warning light four times per second for three seconds.
8. Confirmation of enabling Belt Minder is provided by flashing the safety belt warning light four times per second for three seconds, followed by three seconds with the safety belt warning light off, then followed by flashing the safety belt warning light four times per second for three seconds again.
9. After receiving confirmation, the deactivation/activation procedure is complete.

### Safety belt maintenance

Inspect the safety belt systems periodically to make sure they work properly and are not damaged. Inspect the safety belts to make sure there are no nicks, wears or cuts, replacing if necessary. All safety belt assemblies, including retractors, buckles, front seat belt buckle assemblies, buckle support assemblies (slide bar-if equipped), shoulder belt height adjusters (if equipped), shoulder belt guide on seatback (if equipped), child safety seat tether bracket assemblies (if equipped), and attaching hardware, should be inspected after a collision. Ford recommends that all safety belt assemblies used in vehicles involved in a collision be replaced. However, if the collision was minor and a qualified technician finds that the belts do not show damage and continue to operate properly, they do not need to be replaced. Safety belt assemblies not in use during a collision should also be inspected and replaced if either damage or improper operation is noted.



Failure to inspect and if necessary replace the safety belt assembly under the above conditions could result in severe personal injuries in the event of a collision.



## Seating and safety restraints

Refer to *Cleaning and maintaining the safety belts* in the *Maintenance and care* section.

### AIR BAG SUPPLEMENTAL RESTRAINT SYSTEM (SRS)

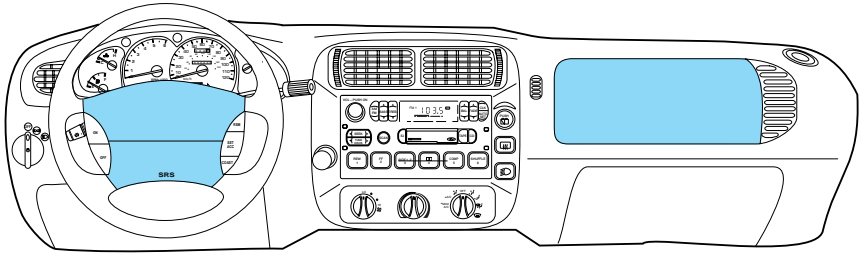

Your vehicle is equipped with a crash sensing and diagnostic module which records information about the air bag and sensor systems. In the event of a collision this module may save information related to the collision including information about the air bag system and impact severity. This information will assist Ford in the servicing of your vehicle and may help Ford better understand real world collisions and further improve the safety of future vehicles.

### Important supplemental restraint system (SRS) precautions

The supplemental restraint system is designed to work with the safety belt to help protect the driver and right front passenger from certain upper body injuries.

Air bags DO NOT inflate slowly or gently and the risk of injury from a deploying air bag is greatest close to the trim covering the air bag module.

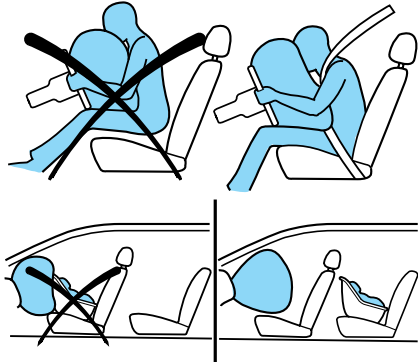

## Seating and safety restraints



All occupants of the vehicle, including the driver, should always properly wear their safety belts, even when an air bag SRS is provided.



Always transport children 12 years old and under in the back seat and always properly use appropriate child restraints.



National Highway Traffic Safety Administration (NHTSA) recommends a minimum distance of at least 25 cm (10 inches) between an occupant's chest and the driver air bag module.



Never place your arm over the air bag module as a deploying air bag can result in serious arm fractures or other injuries.

Steps you can take to properly position yourself away from the air bag:

- Move your seat to the rear as far as you can while still reaching the pedals comfortably.
- Recline the seat slightly (one or two degrees) from the upright position.



Do not put anything on or over the air bag module. Placing objects on or over the air bag inflation area may cause those objects to be propelled by the air bag into your face and torso causing serious injury.



Do not attempt to service, repair, or modify the Air Bag Supplemental Restraint System or its fuses. See your Ford or Lincoln Mercury dealer.

## Seating and safety restraints

### Children and air bags

For additional important safety information, read all information on safety restraints in this guide.

Children must always be properly restrained. Accident statistics suggest that children are safer when properly restrained in the rear seating positions than in the front seating position. Failure to follow these instructions may increase the risk of injury in a collision.

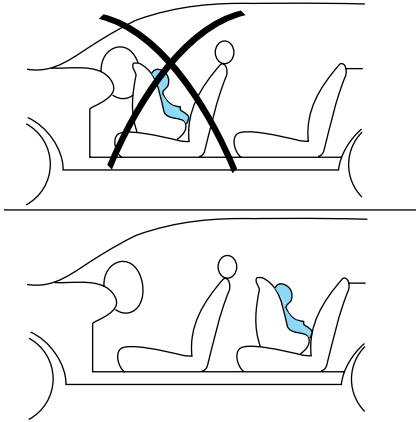

Air bags can kill or injure a child in a child seat.

**NEVER** place a rear-facing child seat in front of an active air bag. If you must use a forward-facing child seat in the front seat, move the seat all the way back.

### How does the air bag supplemental restraint system work?

The air bag SRS is designed to activate when the vehicle sustains longitudinal deceleration sufficient to cause the sensors to close an electrical circuit that initiates air bag inflation.

The fact that the air bags did not inflate in a collision does not mean that something is wrong with the system. Rather, it means the forces were not of the type sufficient to cause activation. Front air bags are designed to inflate in frontal and near-frontal collisions, not rollover, side-impact, or rear-impacts unless the collision causes sufficient longitudinal deceleration.

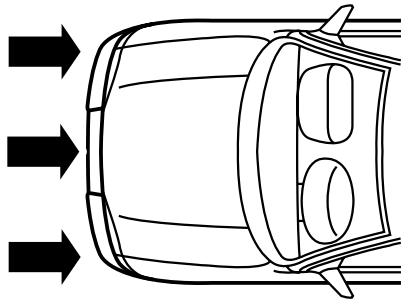

## Seating and safety restraints

The air bags inflate and deflate rapidly upon activation. After air bag deployment, it is normal to notice a smoke-like, powdery residue or smell the burnt propellant. This may consist of cornstarch, talcum powder (to lubricate the bag) or sodium compounds (e.g., baking soda) that result from the combustion process that inflates the air bag. Small amounts of sodium hydroxide may be present which may irritate the skin and eyes, but none of the residue is toxic.



While the system is designed to help reduce serious injuries, contact with a deploying air bag may also cause abrasions, swelling or temporary hearing loss. Because air bags must inflate rapidly and with considerable force, there is the risk of death or serious injuries such as fractures, facial and eye injuries or internal injuries, particularly to occupants who are not properly restrained or are otherwise out of position at the time of air bag deployment. Thus, it is extremely important that occupants be properly restrained as far away from the air bag module as possible while maintaining vehicle control.



Several air bag system components get hot after inflation. Do not touch them after inflation.



If the air bag has deployed, **the air bag will not function again and must be replaced immediately.** If the air bag is not replaced, the unrepaired area will increase the risk of injury in a collision.

The SRS consists of:

- driver and passenger air bag modules (which include the inflators and air bags).
- side air bags (if equipped). Refer to *Side air bag system* later in this chapter.
- one or more impact and safing sensors.

## Seating and safety restraints

- a readiness light and tone.
- diagnostic module.
- and the electrical wiring which connects the components.

The diagnostic module monitors its own internal circuits and the supplemental air bag electrical system warning (including the impact sensors), the system wiring, the air bag system readiness light, the air bag back up power and the air bag ignitors.

### Determining if the system is operational

The SRS uses a readiness light in the instrument cluster or a tone to indicate the condition of the system. Refer to the *Air bag readiness* section in the *Instrumentation* chapter. Routine maintenance of the air bag is not required.

A difficulty with the system is indicated by one or more of the following:

- The readiness light will either flash or stay lit.
- The readiness light will not illuminate immediately after ignition is turned on.
- A series of five beeps will be heard. The tone pattern will repeat periodically until the problem and/or light are repaired.



If any of these things happen, even intermittently, have the SRS serviced at your dealership or by a qualified technician immediately. Unless serviced, the system may not function properly in the event of a collision.

### Side air bag system (if equipped)



Do not place objects or mount equipment on or near the air bag cover on the side of the seatbacks of the front seats or in front seat areas that may come into contact with a deploying air bag. Failure to follow these instructions may increase the risk of personal injury in the event of a collision.



Do not use accessory seat covers. The use of accessory seat covers may prevent the deployment of the side air bags and increase the risk of injury in an accident.

## Seating and safety restraints



Do not lean your head on the door. The side air bag could injure you as it deploys from the side of the seatback.



Do not attempt to service, repair, or modify the air bag Supplemental Restraint System, its fuses or the seat cover on a seat containing an air bag. See your Ford or Lincoln Mercury dealer.



All occupants of the vehicle including the driver should always wear their safety belts even when an air bag SRS is provided.

### ***How does the side air bag system work?***

The side air bag system consists of the following:

- An inflatable nylon bag (air bag) with a gas generator concealed behind the outboard bolster of the driver and front passenger seatbacks.
- A special seat cover designed to allow airbag deployment.
- The same warning light, electronic control and diagnostic unit as used for the front air bags.
- Two crash sensors located on the “B” pillar.

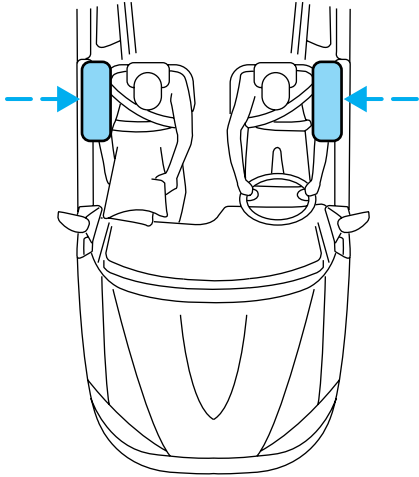

Side air bags, in combination with seat belts, can help reduce the risk of severe injuries in the event of a significant side impact collision.

The side air bags are fitted on the outboard side of the seatbacks of the front seats. In certain lateral collisions, the air bag on the side affected by the collision will be inflated, even if the respective seat is not occupied. The air bag was designed to inflate between the door panel and occupant to further enhance the protection provided occupants in side impact collisions.

## Seating and safety restraints

The air bag SRS is designed to activate when the vehicle sustains lateral deceleration sufficient to cause the sensors to close an electrical circuit that initiates air bag inflation.

The fact that the air bags did not inflate in a collision does not mean that something is wrong with the system. Rather, it means the forces were not of the type sufficient to cause activation. Side air bags are designed to inflate in side-impact collisions, not roll-over, rear-impact, frontal or near-frontal collisions, unless the collision causes sufficient lateral deceleration.



Several air bag system components get hot after inflation. Do not touch them after inflation.



If the side air bag has deployed, **the air bag will not function again. The side air bag system (including the seat) must be inspected and serviced by a qualified technician in accordance with the vehicle service manual.** If the air bag is not replaced, the unrepaired area will increase the risk of injury in a collision.

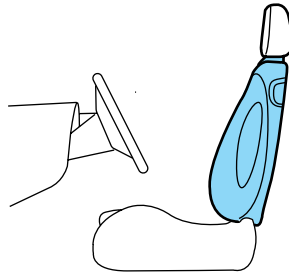

### ***Determining if the system is operational***

The SRS uses a readiness light in the instrument cluster or a tone to indicate the condition of the system. Refer to the *Air bag readiness* section in the *Instrumentation* chapter. Routine maintenance of the air bag is not required.

A difficulty with the system is indicated by one or more of the following:

- The readiness light (same light as for front air bag system) will either flash or stay lit.
- The readiness light will not illuminate immediately after ignition is turned on.

## Seating and safety restraints

- A series of five beeps will be heard. The tone pattern will repeat periodically until the problem and light are repaired.

If any of these things happen, even intermittently, have the SRS serviced at your dealership or by a qualified technician immediately. Unless serviced, the system may not function properly in the event of a collision.

### **Disposal of air bags and air bag equipped vehicles (including pretensioners)**

For disposal of air bags or air bag equipped vehicles, see your local dealership or qualified technician. Air bags **MUST BE** disposed of by qualified personnel.

### **SAFETY RESTRAINTS FOR CHILDREN**

See the following sections for directions on how to properly use safety restraints for children. Also see *Air Bag Supplemental Restraint System (SRS)* in this chapter for special instructions about using air bags.

#### **Important child restraint precautions**

You are required by law to use safety restraints for children in the U.S. and Canada. If small children ride in your vehicle (generally children who are four years old or younger and who weigh 18 kg [40 lbs] or less), you must put them in safety seats made especially for children. Check your local and state or provincial laws for specific requirements regarding the safety of children in your vehicle.



Never let a passenger hold a child on his or her lap while the vehicle is moving. The passenger cannot protect the child from injury in a collision.

Always follow the instructions and warnings that come with any infant or child restraint you might use.

When possible, always place children under age 12 in the rear seat of your vehicle. Accident statistics suggest that children are safer when properly restrained in the rear seating positions than in the front seating position.



## Seating and safety restraints

### Children and safety belts

If the child is the proper size, restrain the child in a safety seat.

Children who are too large for child safety seats (as specified by your child safety seat manufacturer) should always wear safety belts.

Follow all the important safety restraint and air bag precautions that apply to adult passengers in your vehicle.

If the shoulder belt portion of a combination lap and shoulder belt can be positioned so it does not cross or rest in front of the child's face or neck, the child should wear the lap and shoulder belt. Moving the child closer to the center of the vehicle may help provide a good shoulder belt fit.



Do not leave children, unreliable adults, or pets unattended in your vehicle.

To improve the fit of lap and shoulder belts on children who have outgrown child safety seats, Ford recommends use of a belt-positioning booster seat that is labelled as conforming to all applicable Federal motor vehicle safety standards. Belt-positioning booster seats raise the child and provide a shorter, firmer seating cushion that encourages safer seating posture and better fit of lap and shoulder belts on the child.

A belt-positioning booster should be used if the shoulder belt rests in front of the child's face or neck, or if the lap belt does not fit snugly on both thighs, or if the thighs are too short to let the child sit all the way back on the seat cushion when the lower legs hang over the edge of the seat cushion. You may wish to discuss the special needs of your child with your pediatrician.

### SAFETY SEATS FOR CHILDREN



## Seating and safety restraints

### Child and infant or child safety seats

Use a safety seat that is recommended for the size and weight of the child. Carefully follow all of the manufacturer's instructions with the safety seat you put in your vehicle. If you do not install and use the safety seat properly, the child may be injured in a sudden stop or collision.

When installing a child safety seat:

- Review and follow the information presented in the *Air Bag Supplemental Restraint System* section in this chapter.
- Use the correct safety belt buckle for that seating position (the buckle closest to the direction the tongue is coming from).
- Insert the belt tongue into the proper buckle until you hear a snap and feel it latch. Make sure the tongue is securely fastened in the buckle.
- Keep the buckle release button pointing up and away from the safety seat, with the tongue between the child seat and the release button, to prevent accidental unbuckling.
- Place seat back in upright position.
- Put the safety belt in the automatic locking mode. Refer to *Automatic locking mode* (passenger side front and outboard rear seating positions) (if equipped).



Ford recommends the use of a child safety seat having a top tether strap. Install the child safety seat in a seating position which is capable of providing a tether anchorage. For more information on top tether straps, refer to *Attaching safety seats with tether straps*.

## Seating and safety restraints

 Carefully follow all of the manufacturer's instructions included with the safety seat you put in your vehicle. If you do not install and use the safety seat properly, the child may be injured in a sudden stop or collision.

### Installing child safety seats in combination lap and shoulder belt seating positions

 Air bags can kill or injure a child in a child seat. **NEVER** place a rear-facing child seat in front of an active air bag. If you must use a forward-facing child seat in the front seat, move the seat all the way back.

1. Position the child safety seat in a seat with a combination lap and shoulder belt.

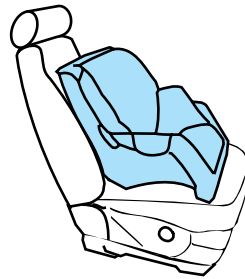

 Children 12 and under should be properly restrained in the rear seat whenever possible.

2. Pull down on the shoulder belt and then grasp the shoulder belt and lap belt together.

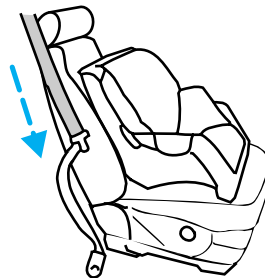

## Seating and safety restraints

3. While holding the shoulder and lap belt portions together, route the tongue through the child seat according to the child seat manufacturer's instructions. Be sure the belt webbing is not twisted.

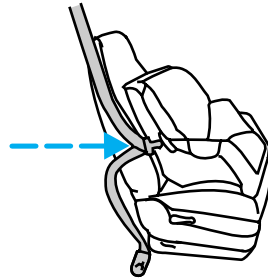

4. Insert the belt tongue into the proper buckle (the buckle closest to the direction the tongue is coming from) for that seating position until you hear a snap and feel the latch engage. Make sure the tongue is latched securely by pulling on it.

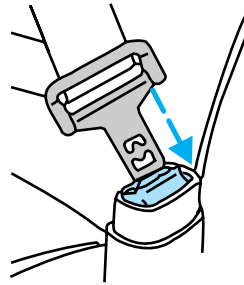

5. To put the retractor in the automatic locking mode, grasp the shoulder portion of the belt and pull downward until all of the belt is extracted and a click is heard.

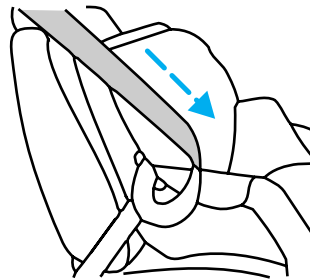

6. Allow the belt to retract. The belt will click as it retracts to indicate it is in the automatic locking mode.

## Seating and safety restraints

7. Pull the lap belt portion across the child seat toward the buckle and pull up on the shoulder belt while pushing down with your knee on the child seat.

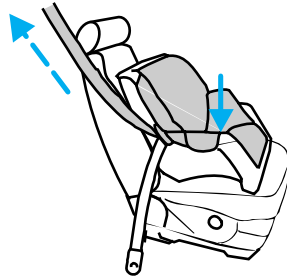

8. Allow the safety belt to retract to remove any slack in the belt.

9. Before placing the child in the seat, forcibly tilt the seat forward and back to make sure the seat is securely held in place.

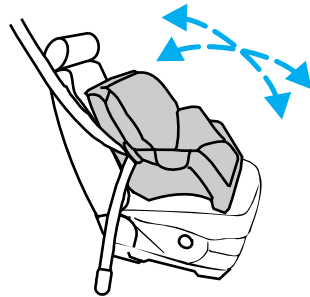

10. Try to pull the belt out of the retractor to make sure the retractor is in the automatic locking mode (you should not be able to pull more belt out). If the retractor is not locked, unbuckle the belt and repeat steps two through nine.

Check to make sure the child seat is properly secured before each use.

### Attaching child safety seats with tether straps

Most new forward-facing child safety seats include a tether strap which goes over the back of the seat and hooks to an anchoring point. Tether straps are available as an accessory for many older safety seats. Contact the manufacturer of your child seat for information about ordering a tether strap.

The rear seats of your vehicle are equipped with built-in tether strap anchors located behind the seats as described below.

The tether anchors in your vehicle are located in the rear cargo area.

## Seating and safety restraints

The tether strap anchors in your vehicle are in the following positions (shown from top view):



Attach the tether strap only to the appropriate tether anchor as shown. The tether strap may not work properly if attached somewhere other than the correct tether anchor.

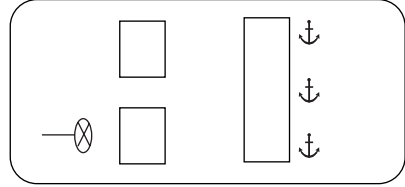

1. Position the child safety seat on the rear seat cushion.
2. Route the child safety seat tether strap over the back of the seat.

For vehicles with adjustable head restraints, route the tether strap under the head restraint and between the head restraint posts, otherwise route the tether strap over the top of the seatback.

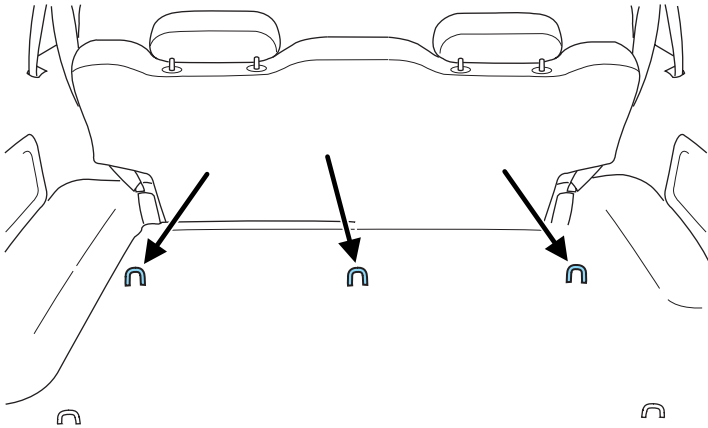

3. Locate the correct anchor for the selected rear seating position. The anchors must remain accessible. Make sure the anchors are not covered by the cargo mat or other objects.

## Seating and safety restraints

4. Clip the tether strap to the anchor.



If the tether strap is clipped incorrectly, the child safety seat may not be retained properly in the event of a collision.

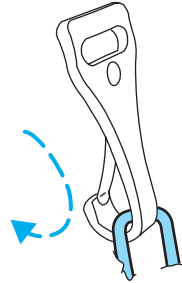

5. Refer to the *Installing child safety seats in combination lap and shoulder belt seating positions* section of this chapter for further instructions to secure the child safety seat.

6. Tighten the child safety seat tether strap according to the manufacturer's instructions.



If the safety seat is not anchored properly, the risk of a child being injured in a collision greatly increases.

## Starting

### PREPARING TO START YOUR VEHICLE

Engine starting is controlled by the powertrain control system. This system meets all Canadian Interference-Causing Equipment standard requirements regulating the impulse electrical field strength of radio noise.

When starting a fuel-injected engine, avoid pressing the accelerator before or during starting. Only use the accelerator when you have difficulty starting the engine. For more information on starting the vehicle, refer to *Starting the engine* in this chapter.



Extended idling at high engine speeds can produce very high temperatures in the engine and exhaust system, creating the risk of fire or other damage.



Do not park, idle, or drive your vehicle in dry grass or other dry ground cover. The emission system heats up the engine compartment and exhaust system, which can start a fire.



Do not start your vehicle in a closed garage or in other enclosed areas. Exhaust fumes can be toxic. Always open the garage door before you start the engine. See *Guarding against exhaust fumes* in this chapter for more instructions.



If you smell exhaust fumes inside your vehicle, have your dealer inspect your vehicle immediately. Do not drive if you smell exhaust fumes.

### Important safety precautions

A computer system controls the engine's idle revolutions per minute (RPM). When the engine starts, the idle RPM runs faster to warm the engine. If the engine idle speed does not slow down automatically, have the vehicle checked.

Before starting the vehicle:

1. Make sure all vehicle occupants have buckled their safety belts. For more information on safety belts and their proper usage, refer to the *Seating and safety restraints* chapter.



## Starting

2. Make sure the headlamps and vehicle accessories are off.

- Make sure the parking brake is set.

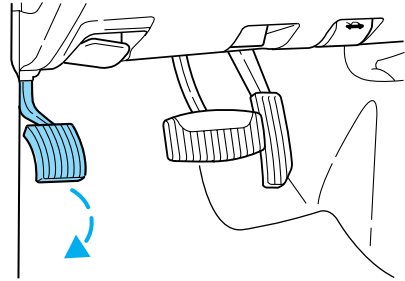

- Make sure the gearshift is in P (Park).



3. Turn the key to 4 (ON) without turning the key to 5 (START).

If there is difficulty in turning the key, firmly rotate the steering wheel left and right until the key turns freely. This condition may occur when:

- front wheels are turned
- front wheel is against the curb
- steering wheel is turned when getting in or out of the vehicle

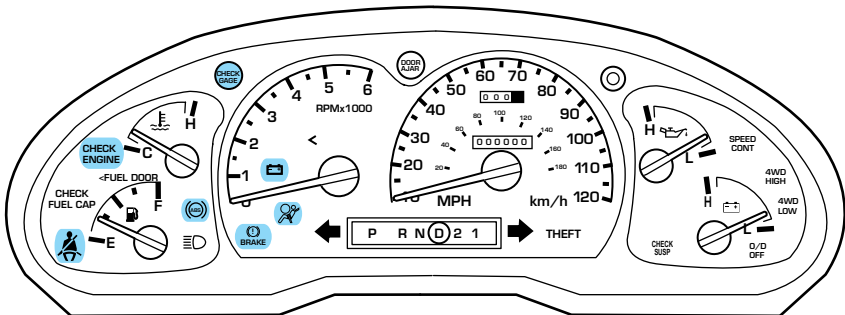
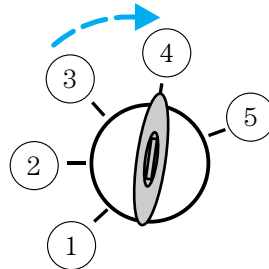

## Starting

Make sure the corresponding lights illuminate briefly. If a light fails to illuminate, have the vehicle serviced.

- If the driver's safety belt is fastened, the  light may not illuminate.

### STARTING THE ENGINE

1. Turn the key to 5 (START) without pressing the accelerator pedal and release as soon as the engine starts. The key will return to 4 (ON).

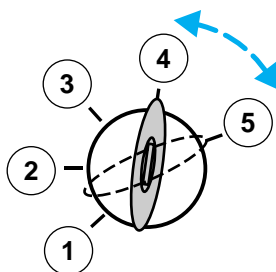

2. If the temperature is above  $-12^{\circ}\text{C}$  ( $10^{\circ}\text{F}$ ) and the engine does not start within five seconds on the first try, turn the key to OFF, wait 10 seconds and try again.

3. If the temperature is below  $-12^{\circ}\text{C}$  ( $10^{\circ}\text{F}$ ) and the engine does not start in 15 seconds on the first try, turn the key OFF and wait 10 seconds and try again. If the engine does not start in two attempts, press the accelerator pedal all the way to floor and hold. Turn the key to START position.

4. When the engine starts, release the key, then release the accelerator pedal gradually as the engine speeds up.

5. After idling for a few seconds, apply the brake and release the parking brake.

### Using the engine block heater (if equipped)

An engine block heater warms the engine coolant, which improves starting, warms up the engine faster and allows the heater-defroster system to respond quickly. Use of an engine block heater is strongly recommended if you live in a region where temperatures reach  $-23^{\circ}\text{C}$  ( $-10^{\circ}\text{F}$ ) or below.

For best results, plug the heater in at least three hours before starting the vehicle. Using the heater for longer than three hours will not harm the engine, so the heater can be plugged in the night before starting the vehicle.



To prevent electrical shock, do not use your heater with ungrounded electrical systems or two-pronged (cheater) adapters.

### Guarding against exhaust fumes

Although odorless and colorless, carbon monoxide is present in exhaust fumes. Take precautions to avoid its dangerous effects.



If you ever smell exhaust fumes of any kind inside your vehicle, have your dealer inspect and fix your vehicle immediately. Do not drive if you smell exhaust fumes. These fumes are harmful and could kill you.

Have the exhaust and body ventilation systems checked whenever:

- the vehicle is raised for service.
- the sound of the exhaust system changes.
- the vehicle has been damaged in a collision.



**WARNING:** Engine exhaust, some of its constituents, and certain vehicle components contain or emit chemicals known to the State of California to cause cancer and birth defects or other reproductive harm. In addition, certain fluids contained in vehicles and certain products of component wear contain or emit chemicals known to the State of California to cause cancer and birth defects or other reproductive harm.

### Important ventilating information

If the engine is idling while the vehicle is stopped in an open area for long periods of time, open the windows at least 2.5 cm (one inch).

Adjust the heating or air conditioning (if equipped) to bring in fresh air.

## Starting

Improve vehicle ventilation by keeping all air inlet vents clear of snow, leaves and other debris.

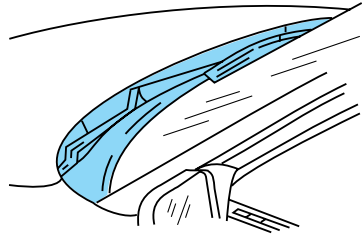

### BRAKES

Your service brakes are self-adjusting. Refer to the scheduled maintenance guide for scheduled maintenance.

Occasional brake noise is normal and often does not indicate a performance concern with the vehicle's brake system. In normal operation, automotive brake systems may emit occasional or intermittent squeal or groan noises when the brakes are applied. Such noises are usually heard during the first few brake applications in the morning; however, they may be heard at any time while braking and can be aggravated by environmental conditions such as cold, heat, moisture, road dust, salt or mud. If a "metal-to-metal," "continuous grinding" or "continuous squeal" sound is present while braking, the brake linings may be worn-out and should be inspected by a qualified service technician.

### Anti-lock brake system (ABS)

On vehicles equipped with an anti-lock braking system (ABS), a noise from the hydraulic pump motor and pulsation in the pedal may be observed during ABS braking events. Pedal pulsation coupled with noise while braking under panic conditions or on loose gravel, bumps, wet or snowy roads is normal and indicates proper functioning of the vehicle's anti-lock brake system. The ABS performs a self-check after you start the engine and begin to drive away. A brief mechanical noise may be heard during this test. This is normal. If a malfunction is found, the ABS warning light will come on. If the vehicle has continuous vibration or shudder in the steering wheel while braking, the vehicle should be inspected by a qualified service technician.

The ABS operates by detecting the onset of wheel lockup during brake applications and compensates for this tendency. The wheels are prevented from locking even when the brakes are firmly applied. The accompanying illustration depicts the advantage of an ABS equipped vehicle (on bottom) to a non-ABS equipped vehicle (on top) during hard braking with loss of front braking traction.

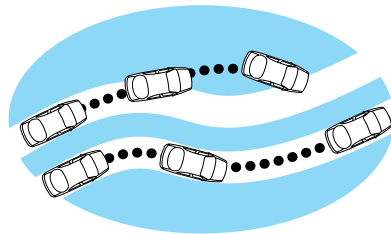

## Driving

### ABS warning lamp (ABS)

The (ABS) warning lamp in the instrument cluster momentarily illuminates when the ignition is turned to the ON position. If the light does not illuminate momentarily at start up, remains on or continues to flash, the ABS needs to be serviced.

With the ABS light on, the anti-lock brake system is disabled and normal braking is still effective unless the brake warning light also remains illuminated with parking brake released. (If your brake warning lamp illuminates, have your vehicle serviced immediately.)



### Using ABS

- In an emergency or when maximum efficiency from the four wheel ABS is required, apply continuous force on the brake. The four wheel ABS will be activated immediately, thus allowing you to retain full steering control of your vehicle and, providing there is sufficient space, will enable you to avoid obstacles and bring the vehicle to a controlled stop.
- The Anti-Lock system does not decrease the time necessary to apply the brakes or always reduce stopping distance. Always leave enough room between your vehicle and the vehicle in front of you to stop.
- We recommend that you familiarize yourself with this braking technique. However, avoid taking any unnecessary risks.

### Parking brake (P)

Apply the parking brake whenever the vehicle is parked. To set the parking brake, press the parking brake pedal down until the pedal stops.

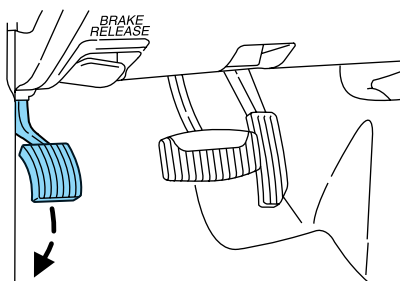

The BRAKE warning lamp in the instrument cluster illuminates and remains illuminated (when the ignition is turned ON) until the parking brake is released.



Always set the parking brake fully and make sure that the gearshift is securely latched in P (Park) (automatic transmission) or in 1 (First) (manual transmission).

The parking brake is not recommended to stop a moving vehicle. However, if the normal brakes fail, the parking brake can be used to stop your vehicle in an emergency. Since the parking brake applies only the rear brakes, the vehicle's stopping distance will increase greatly and the handling of your vehicle will be adversely affected.

Pull the release lever to release the brake. Driving with the parking brake on will cause the brakes to wear out quickly and reduce fuel economy.

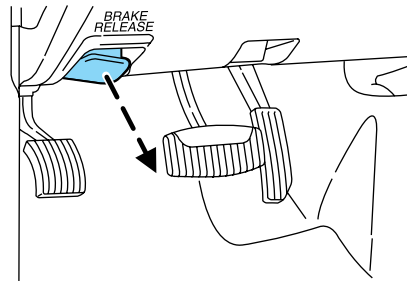

## STEERING

Your vehicle is equipped with power steering. Power steering uses energy from the engine to help steer the vehicle.

To prevent damage to the power steering pump:

- Never hold the steering wheel to the extreme right or the extreme left for more than a few seconds when the engine is running.
- Do not operate the vehicle with a low power steering pump fluid level (below the MIN mark on the reservoir).

If the power steering system breaks down (or if the engine is turned off), you can steer the vehicle manually, but it takes more effort.

## Driving

If the steering wanders or pulls, the condition could be caused by any of the following:

- underinflated tire(s) on any wheel(s)
- high crown in center of road
- high crosswinds
- wheels out of alignment
- loose or worn components in steering linkage

### AIR SUSPENSION SYSTEM (IF EQUIPPED)

The load leveling feature of the air suspension automatically keeps the vehicle at a constant level if a load is added or removed from the vehicle.

This system maintains the vehicle height at a constant level by automatically adding air or releasing air from the springs to offset changes in vehicle loads.

When ever a door is opened (including the liftgate) the system memorizes and maintains the height of the vehicle until all doors are closed.

It is normal to hear a buzz or clicking from the air compressor on the vehicle when the ignition is turned off. The system stays energized for 40 minutes after the ignition is turned off to compensate for any load changes made after the vehicle is parked.

The air suspension shut-off switch is located in the cargo area behind the left rear quarter trim panel.



On vehicles equipped with Air Suspension, turn OFF the Air Suspension switch prior to jacking, hoisting or towing your vehicle.

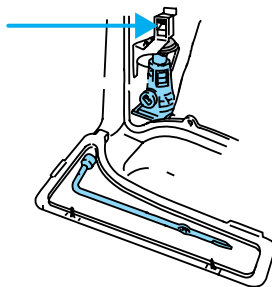

Normal vehicle operation does not require any action by the driver.



### PREPARING TO DRIVE YOUR VEHICLE



Utility vehicles have a significantly higher rollover rate than other types of vehicles.



In a rollover crash, an unbelted person is significantly more likely to die than a person wearing a seat belt.

Your vehicle has special design and equipment features to make it capable of performing in a wide variety of circumstances. These special design features, such as larger tires and increased ground clearance, give the vehicle a higher center of gravity than a passenger car.



Vehicles with a higher center of gravity such as utility and four-wheel drive vehicles handle differently than vehicles with a lower center of gravity. Utility and four-wheel drive vehicles are **not** designed for cornering at speeds as high as passenger cars any more than low-slung sports cars are designed to perform satisfactorily under off-road conditions. Avoid sharp turns, excessive speed and abrupt maneuvers in these vehicles. Failure to drive cautiously could result in an increased risk of vehicle rollover, personal injury and death.



Loaded vehicles, with a higher center of gravity, may handle differently than unloaded vehicles. Extra precautions, such as slower speeds and increased stopping distance, should be taken when driving a heavily loaded vehicle.

Your vehicle has the capability to haul more cargo and people than most passenger cars. Depending upon the type and placement of the load, hauling people and cargo may raise the center of gravity of the vehicle.

Use extra caution while becoming familiar with your vehicle. Know the capabilities and limitations of both you as a driver and your vehicle.

### AUTOMATIC TRANSMISSION OPERATION

#### Brake-shift interlock

This vehicle is equipped with a brake-shift interlock feature that prevents the gearshift lever from being moved from P (Park) when the ignition is in the ON position unless brake pedal is depressed.

## Driving

If you cannot move the gearshift lever out of P (Park) with ignition in the ON position and the brake pedal depressed:

1. Apply the parking brake, turn ignition key to LOCK, then remove the key.
2. Insert the key and turn it to OFF. Apply the brake pedal and shift to N (Neutral).
3. Start the vehicle.

If it is necessary to use the above procedure to move the gearshift lever, it is possible that a fuse has blown or the vehicle's brakelamps are not operating properly. Refer to *Fuses and relays* in the *Roadside emergencies* chapter.



Do not drive your vehicle until you verify that the brakelamps are working.

If your vehicle gets stuck in mud or snow it may be rocked out by shifting between forward and reverse gears, stopping between shifts, in a steady pattern. Press lightly on the accelerator in each gear.

**Do not rock the vehicle if the engine is not at normal operating temperature or damage to the transmission may occur.**

**Do not rock the vehicle for more than a few minutes or damage to the transmission and tires may occur or the engine may overheat.**



Always set the parking brake fully and make sure the gearshift is latched in P (Park). Turn off the ignition whenever you leave your vehicle.



If the parking brake is fully released, but the brake warning lamp remains illuminated, the brakes may not be working properly. See your dealer or a qualified service technician.

### Driving with a 4-speed automatic transmission (if equipped)

To put your vehicle in gear, start the engine, depress the brake pedal, then move gearshift lever out of P (Park).



Hold the brake pedal down while you move the gearshift lever from P (Park) to another position. If you do not hold the brake pedal down, your vehicle may move unexpectedly and injure someone.

## Understanding gearshift positions

### P (Park)

Always come to a complete stop before shifting into P (Park). Make sure the gearshift lever is securely latched in P (Park). This position locks the transmission and prevents the rear wheels from turning.



Always set the parking brake fully and make sure the gearshift lever is latched in P (Park). Turn off the ignition whenever you leave your vehicle.

### R (Reverse)

With the gearshift in R (Reverse), the vehicle will move backward. Always come to a complete stop before shifting into and out of R (Reverse).



### N (Neutral)

With the gearshift in N (Neutral), the vehicle can be started and is free to roll. Hold the brake pedal down while in this gear.



### D (Overdrive)

The normal driving position for the best fuel economy. Transmission operates in gears one through four.



**D** (Overdrive) can be deactivated by pressing the transmission control switch on the gearshift lever.

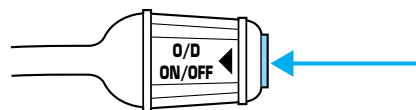

## Driving

The transmission control indicator light (TCIL) will illuminate on the instrument cluster.

O/D  
OFF

**Drive** – Not shown on the display. Activate by pressing the transmission control switch on the end of the gearshift lever with the gearshift in the **D** position. The O/D OFF indicator will illuminate on the instrument cluster. Transmission operates in gears one through three. **D** (Drive) provides more engine braking than **D** (Overdrive) and is useful when:

- driving with a heavy load.
- towing a trailer up or down steep hills.
- additional engine braking is desired. If towing a trailer, refer to *Driving while you tow* in the *Trailer Towing* chapter.

To return to **D** (Overdrive) mode, press the transmission control switch. The O/D OFF indicator will no longer be illuminated.

Each time the vehicle is started, the transmission will automatically return to normal overdrive mode.

Every time the vehicle is shut off and restarted, you must press the transmission control switch to cancel overdrive operation if driving in overdrive is not desired.

### 2 (Second)

Use 2 (Second) to start-up on slippery roads or to provide additional engine braking on downgrades. Transmission operates only in Second gear.



### 1 (First)

Use 1 (Low) to provide maximum engine braking on steep downgrades. Upshifts can be made by shifting to 2 (Second) or to **D** (Overdrive). Selecting 1 (Low) at



higher speeds causes the transmission to shift to a lower gear, and will shift to 1 (Low) after vehicle decelerates to the proper speed.

### **Forced Downshifts**

To gain acceleration in **D** (Overdrive) or Drive (O/D OFF) when passing another vehicle, push the accelerator to the floor. The transmission will downshift to the appropriate gear: third, second or first gear.

### **Driving with a 5–speed automatic transmission (if equipped)**

Your automatic transmission electronically controls the shift feel by using an adaptive learning strategy. This feature is designed to increase durability, and provide consistent shift feel over the life of the vehicle. It is normal for a new transmission to shift firmly. This operation is considered normal and will not affect function or durability of the transmission. Once the vehicle is at operating temperature it may take several shifts at the same operating condition for the transmission to properly adapt. Over time the adaptive learning process will fully update transmission operation. The more varied the driving habits, speed and torque, the longer it may take to adapt but the more complete the process will be.

When the battery is disconnected or a new battery installed, the transmission must learn its adaptive strategy. As a result of this, the transmission may shift firmly. This operation is considered normal and will fully update transmission operation to its optimum shift feel.

### **Understanding gearshift positions**



Hold the brake pedal down while you move the gearshift lever from P (Park) to another position. If you do not hold the brake pedal down, your vehicle may move unexpectedly and injure someone.

### **P (Park)**

To put your vehicle in gear, start the engine, depress the brake pedal, then move gearshift lever out of P (Park).

Always come to a complete stop before shifting into P (Park). Make sure the gearshift lever is securely latched in P (Park). This position



locks the transmission and prevents the rear wheels from turning.



Always set the parking brake fully and make sure the gearshift is latched in P (Park). Turn off the ignition whenever you leave your vehicle.

## Driving

### **R (Reverse)**

With the gearshift lever in R (Reverse), the vehicle will move backward. Always come to a complete stop before shifting into and out of R (Reverse).



### **N (Neutral)**

With the gearshift lever in N (Neutral), the vehicle can be started and is free to roll. Hold the brake pedal down while in this position.



### **D (Overdrive)**

The normal driving position for the best fuel economy. Transmission operates in gears one through five.



**D** (Overdrive) can be deactivated by pressing the transmission control switch on the end of the gearshift lever.

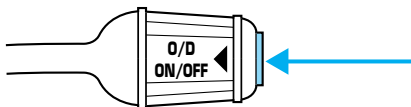

The transmission control indicator light (TCIL) will illuminate on the instrument cluster.

O/D  
OFF

**Drive** – Not shown on the display. Activate by pressing the transmission control switch on the end of the gearshift lever with the gearshift in the **D** (Overdrive) position. The TCIL will illuminate on the instrument cluster. Transmission operates in gears one through four. Drive (O/D OFF) provides more engine braking than **D** (Overdrive) and is useful whenever driving conditions (i.e., city traffic, hilly terrain, etc.) cause the transmission to excessively shift between **D** (Overdrive) and other gears. Deactivate **D** (Overdrive) when:

- driving with a heavy load.
- towing a trailer up or down steep hills.
- additional engine braking is desired. If towing a trailer, refer to *Driving while you tow* in the *Trailer Towing* chapter.

To return to **D** (Overdrive) mode, press the transmission control switch. The TCIL will no longer be illuminated.

Each time the vehicle is started, the transmission will automatically return to normal **D** (Overdrive) mode.

## 2 (Second)

Use 2 (Second) to start-up on slippery roads or to provide additional engine braking on downgrades.



## 1 (First)

Use 1 (First) to provide maximum engine braking on steep downgrades. Upshifts can be made by shifting to 2 (Second) or to **D** (Overdrive).



Selecting 1 (Low) at higher speeds causes the transmission to shift to a lower gear and will shift to 1 (First) after the vehicle decelerates to the proper vehicle speed.

## Forced Downshifts

To gain acceleration in **D** (Overdrive) or Drive (O/D OFF) when passing another vehicle, push the accelerator to the floor. The transmission will downshift to the appropriate gear: fourth, third, second or first gear.

## FOUR-WHEEL DRIVE (4WD) OPERATION (IF EQUIPPED)



For important information regarding safe operation of this type of vehicle, see **Preparing to drive your vehicle** in this chapter.

When Four-wheel drive (4WD) is engaged, power is supplied to all four wheels through a transfer case. 4WD power can be selected when additional driving power is desired.

**If equipped with the Electronic Shift 4WD System, and the 4x4 Low button is pressed while the vehicle is moving, the system will not engage and no damage will occur to the 4WD system.**

**4x4 High and 4x4 Low operation is not recommended on dry pavement. Doing so could result in difficult disengagement of the transfer case, increased tire wear and decreased fuel economy.**

## Driving

### Control-Trac automatic four-wheel drive system (if equipped)

The 4WD system uses all four wheels to power the vehicle. This increases traction, enabling you to drive your 4x4 over terrain and road conditions not normally traveled by two-wheel drive vehicles.

Power is supplied to all four wheels through a transfer case that allows you to select a four-wheel drive mode best suited for your current driving conditions.

### Positions of the Control-Trac system

The Control-Trac system functions in three modes:

- The 4WD AUTO mode provides four-wheel drive with full power delivered to the rear axle, and to the front axle as required for increased traction. This is appropriate for normal on-road operating conditions, such as dry road surfaces, wet pavement, snow and gravel.
- The 4WD HIGH mode provides four-wheel drive with full power to both axles. It is only intended for severe winter or off-road conditions, such as deep snow and ice (where no dry or wet pavement remains uncovered), and shallow sand.

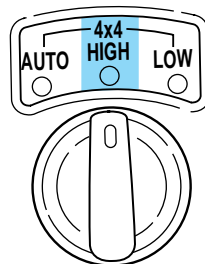
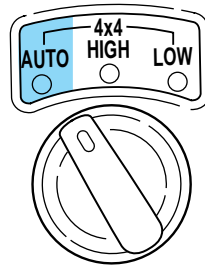



- The 4WD LOW mode supplies four-wheel drive with full power to both axles and includes a lower gear ratio for low-speed. It is only intended for off-road applications that require extra power including deep sand, steep grades and pulling a boat and trailer out of the water.

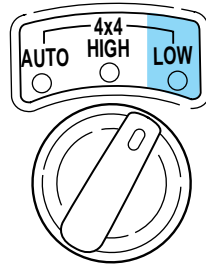

**The vehicle should not be operated in 4WD HIGH and 4WD LOW on dry or merely wet pavement. Doing so will produce excessive noise, increase tire wear and may damage driveline components. These modes are intended for use only on consistently slippery or loose surfaces.**

**If your vehicle is equipped with 4WD or AWD, a spare tire of a different size than the road tires should never be used. Such a tire could result in damage to driveline components and make the vehicle difficult to control.**



Utility and four-wheel drive vehicles are **not** designed for cornering at speeds as high as passenger cars any more than low-slung sports cars are designed to perform satisfactorily under off-road conditions. Avoid sharp turns or abrupt maneuvers in these vehicles.

### Using the Control-Trac system

#### **Shifting between 4WD AUTO and 4WD HIGH**

When you move the control to 4WD HIGH, the indicator light will illuminate in the instrument cluster. When you move the control to 4WD AUTO, the indicator light will turn off.

Either shift can be done at a stop or while driving at any speed.

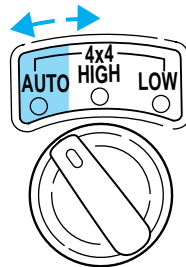

## Driving

### **Shifting from 4WD AUTO or 4WD HIGH to 4WD LOW**

1. Bring the vehicle to a stop.
2. Depress the brake.
3. Place the gearshift in N (Neutral).
4. Move the 4WD control to the 4WD LOW position.

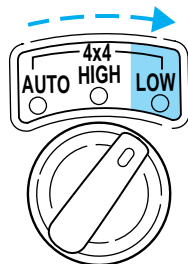

### **Shifting from 4WD LOW to 4WD AUTO or 4WD HIGH**

1. Bring the vehicle to a stop.
2. Depress the brake.
3. Place the gearshift in N (Neutral).
4. Move the 4WD control to the 4WD AUTO or 4WD HIGH position.

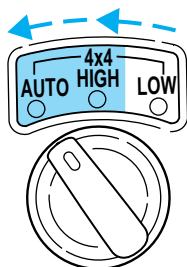

### **Driving off-road with 4WD**

Your vehicle is specially equipped for driving on sand, snow, mud and rough terrain and has operating characteristics that are somewhat different from conventional vehicles, both on and off the road.

Maintain steering wheel control at all times, especially in rough terrain. Since sudden changes in terrain can result in abrupt steering wheel motion, make sure you grip the steering wheel from the outside. Do not grip the spokes.

Drive cautiously to avoid vehicle damage from concealed objects such as rocks and stumps.

You should either know the terrain or examine maps of the area before driving. Map out your route before driving in the area. For more information on driving off-road, read the “Four Wheeling” supplement in your owner’s portfolio.

### ***If your vehicle gets stuck***

If the vehicle is stuck in mud or snow it may be rocked out by shifting from forward and reverse gears, stopping between shifts, in a steady pattern. Press lightly on the accelerator in each gear.

**Do not rock the vehicle if the engine is not at normal operating temperature or damage to the transmission may occur.**

**Do not rock the vehicle for more than a few minutes or damage to the transmission and tires may occur or the engine may overheat.**



Do not spin the wheels at over 56 km/h (35 mph). The tires may fail and injure a passenger or bystander.

### ***Sand***

When driving over sand, try to keep all four wheels on the most solid area of the trail. Do not reduce the tire pressures but shift to a lower gear and drive steadily through the terrain. Apply the accelerator slowly and avoid spinning the wheels.

### ***Mud and water***

If you must drive through high water, drive slowly. Traction or brake capability may be limited.

When driving through water, determine the depth; avoid water higher than the bottom of the hubs (if possible) and proceed slowly. If the ignition system gets wet, the vehicle may stall.

Once through water, always try the brakes. Wet brakes do not stop the vehicle as effectively as dry brakes. Drying can be improved by moving your vehicle slowly while applying light pressure on the brake pedal.

After driving through mud, clean off residue stuck to rotating driveshafts and tires. Excess mud stuck on tires and rotating driveshafts causes an imbalance that could damage drive components.

If the transmission, transfer case or front axle are submerged in water, their fluids should be checked and changed, if necessary.

**Water intrusion into the transmission may damage the transmission.**

## Driving

If the rear axle is submerged in water, the rear axle lubricant should be checked and changed, if necessary. The rear axle is filled with a synthetic lubricant and does not normally require a lubricant change for the life of the vehicle. Rear axle lubricant quantities should not need to be checked unless a leak is suspected.

### ***Driving on hilly or sloping terrain***

When driving on a hill, avoid driving crosswise or turning on steep slopes. You could lose traction and slip sideways. Drive straight up, straight down or avoid the hill completely. Know the conditions on the other side of a hill before driving over the crest.

When climbing a steep hill, start in a lower gear rather than downshifting to a lower gear from a higher gear once the ascent has started. This reduces the strain on the engine.

When descending a steep hill, avoid sudden braking. Shift to a lower gear when added engine braking is desired.

When speed control is on and you are driving uphill, your vehicle speed may drop considerably, especially if you are carrying a heavy load.

If vehicle speed drops more than 16 km/h (10 mph), the speed control will cancel automatically. Resume speed with accelerator pedal.

If speed control cancels after climbing the hill, reset speed by pressing and holding the SET ACCEL button (to resume speeds over 50 km/h (30 mph)).

Automatic transmissions may shift frequently while driving up steep grades. Eliminate frequent shifting by shifting out of **D** (Overdrive) into D (Drive).

### ***Driving on snow and ice***

A 4WD vehicle has advantages over 2WD vehicles in snow and ice but can skid like any other vehicle.

Avoid sudden applications of power and quick changes of direction on snow and ice. Apply the accelerator slowly and steadily when starting from a full stop.

When braking, apply the brakes as you normally would. In order to allow the anti-lock brake system (ABS) to operate properly, keep steady pressure on the brake pedal.

Allow more stopping distance and drive slower than usual. Consider using one of the lower gears.

### **ALL WHEEL DRIVE (AWD) SYSTEM (IF EQUIPPED) (5.0L ENGINES ONLY)**

Your vehicle is equipped with a full-time All Wheel Drive (AWD) transfer case. Power is supplied to all four wheels all the time with no need to shift between two-wheel drive and four-wheel drive.

For the lubricant specification and refill capacity of the AWD transfer case refer to *Capacities and specifications* chapter.



Utility and four-wheel drive vehicles are **not** designed for cornering at speeds as high as passenger cars any more than low-slung sports cars are designed to perform satisfactorily under off-road conditions. Avoid sharp turns or abrupt maneuvers in these vehicles.

### **Driving off-road with AWD**

Your vehicle is specially equipped for driving on sand, snow, mud and rough terrain and has operating characteristics that are somewhat different from conventional vehicles, both on and off the road.

Maintain steering wheel control at all times, especially in rough terrain. Since sudden changes in terrain can result in abrupt steering wheel motion, make sure you grip the steering wheel from the outside. Do not grip the spokes.

Drive cautiously to avoid vehicle damage from concealed objects such as rocks and stumps.

You should either know the terrain or examine maps of the area before driving. Map out your route before driving in the area. For more information on driving off-road, read the “Four Wheeling” supplement in your owner’s portfolio.

#### ***If your vehicle gets stuck***

If the vehicle is stuck in mud or snow it may be rocked out by shifting from forward and reverse gears, stopping between shifts, in a steady pattern. Press lightly on the accelerator in each gear.

**Do not rock the vehicle if the engine is not at normal operating temperature or damage to the transmission may occur.**

**Do not rock the vehicle for more than a few minutes or damage to the transmission and tires may occur or the engine may overheat.**

## Driving



Do not spin the wheels at over 56 km/h (35 mph). The tires may fail and injure a passenger or bystander.

### ***Sand***

When driving over sand, try to keep all four wheels on the most solid area of the trail. Do not reduce the tire pressures but shift to a lower gear and drive steadily through the terrain. Apply the accelerator slowly and avoid spinning the wheels.

### ***Mud and water***

If you must drive through high water, drive slowly. Traction or brake capability may be limited.

When driving through water, determine the depth; avoid water higher than the bottom of the hubs (if possible) and proceed slowly. If the ignition system gets wet, the vehicle may stall.

Once through water, always try the brakes. Wet brakes do not stop the vehicle as effectively as dry brakes. Drying can be improved by moving your vehicle slowly while applying light pressure on the brake pedal.

After driving through mud, clean off residue stuck to rotating driveshafts, halfshafts and tires. Excess mud stuck on tires and rotating driveshafts causes an imbalance that could damage drive components.

If the transmission, transfer case or front axle are submerged in water, their fluids should be checked and changed, if necessary.

### **Water intrusion into the transmission may damage the transmission.**

If the rear axle is submerged in water, the rear axle lubricant should be checked and changed, if necessary. The rear axle is filled with a synthetic lubricant and does not normally require a lubricant change for the life of the vehicle. Rear axle lubricant quantities should not need to be checked unless a leak is suspected.

### ***Driving on hilly or sloping terrain***

When driving on a hill, avoid driving crosswise or turning on steep slopes. You could lose traction and slip sideways. Drive straight up, straight down or avoid the hill completely. Know the conditions on the other side of a hill before driving over the crest.

When climbing a steep hill, start in a lower gear rather than downshifting to a lower gear from a higher gear once the ascent has started. This reduces strain on the engine and the possibility of stalling.

When descending a steep hill, avoid sudden braking. Shift to a lower gear when added engine braking is desired.

When speed control is on and you are driving uphill, your vehicle speed may drop considerably, especially if you are carrying a heavy load.

If vehicle speed drops more than 16 km/h (10 mph), the speed control will cancel automatically. Resume speed with accelerator pedal.

If speed control cancels after climbing the hill, reset speed by pressing and holding the SET ACCEL button (to resume speeds over 50 km/h [30 mph]).

Automatic transmissions may shift frequently while driving up steep grades. Eliminate frequent shifting by shifting out of **D** (Overdrive) into D (Drive).

### ***Driving on snow and ice***

An AWD vehicle has advantages over 2WD vehicles in snow and ice but can skid like any other vehicle.

Avoid sudden applications of power and quick changes of direction on snow and ice. Apply the accelerator slowly and steadily when starting from a full stop.

When braking, apply the brakes as you normally would. In order to allow the anti-lock brake system (ABS) to operate properly, keep steady pressure on the brake pedal.

Allow more stopping distance and drive slower than usual. Consider using one of the lower gears.

### **TRACTION-LOK AXLE (IF EQUIPPED)**

This axle provides added traction on slippery surfaces, particularly when one wheel is on a poor traction surface. Under normal conditions, the Traction-Lok axle functions like a standard rear axle.

Extended use of other than the manufacturer's specified size tires on a Traction-Lok rear axle could result in a permanent reduction in effectiveness. This loss of effectiveness does not affect normal driving and should not be noticeable to the driver.



To avoid injury, never run the engine with one wheel off the ground, such as when changing a tire.

## Driving

### VEHICLE LOADING

Before loading a vehicle, familiarize yourself with the following terms:

- **Base Curb Weight:** Weight of the vehicle including any standard equipment, fluids, lubricants, etc. It does not include passengers or aftermarket equipment.
- **Payload:** Combined maximum allowable weight of cargo, passengers and optional equipment. The payload equals the gross vehicle weight rating minus base curb weight.
- **GVW (Gross Vehicle Weight):** Base curb weight plus payload weight. The GVW is not a limit or a specification.
- **GVWR (Gross Vehicle Weight Rating):** Maximum total weight of the base vehicle, passengers, optional equipment and cargo. The GVWR is specific to each vehicle and is listed on the Safety Certification Label on the driver's door pillar.
- **GAWR (Gross Axle Weight Rating):** Carrying capacity for each axle system. The GAWR is specific to each vehicle and is listed on the Safety Certification Label on the driver's door pillar.
- **GCW (Gross Combined Weight):** The combined weight of the towing vehicle (including passengers and cargo) and the trailer.
- **GCWR (Gross Combined Weight Rating):** Maximum combined weight of towing vehicle (including passengers and cargo) and the trailer. The GCWR indicates the maximum loaded weight that the vehicle is designed to tow.
- **Maximum Trailer Weight Rating:** Maximum weight of a trailer the vehicle is permitted to tow. The maximum trailer weight rating is determined by subtracting the vehicle curb weight for each engine/transmission combination, any required option weight for trailer towing and the weight of the driver from the GCWR for the towing vehicle.
- **Maximum Trailer Weight:** Maximum weight of a trailer the loaded vehicle (including passengers and cargo) is permitted to tow. It is determined by subtracting the weight of the loaded trailer towing vehicle from the GCWR for the towing vehicle.
- **Trailer Weight Range:** Specified weight range that the trailer must fall within that ranges from zero to the maximum trailer weight rating.

Remember to figure in the tongue load of your loaded trailer when figuring the total weight.





Do not exceed the GVWR or the GAWR specified on the certification label.

Do not use replacement tires with lower load carrying capacities than the originals because they may lower the vehicle's GVWR and GAWR limitations. Replacement tires with a higher limit than the originals do not increase the GVWR and GAWR limitations.

The Safety Certification Label, found on the driver's door pillar, lists several important vehicle weight rating limitations. Before adding any additional equipment, refer to these limitations. If you are adding weight to the front of your vehicle, (potentially including weight added to the cab), the weight added should not exceed the front axle reserve capacity (FARC). Additional frontal weight may be added to the front axle reserve capacity provided you limit your payload in other ways (i.e. restrict the number of passengers or amount of cargo carried).

Always ensure that the weight of passengers, cargo and equipment being carried is within the weight limitations that have been established for your vehicle including both gross vehicle weight and Front and rear gross axle weight rating limits. Under no circumstance should these limitations be exceeded. Exceeding any vehicle weight rating limitation could result in serious damage to the vehicle and/or personal injury.

### Special loading instructions for owners of pickup trucks and utility-type vehicles



For important information regarding safe operation of this type of vehicle, see the **Preparing to drive your vehicle** section in the **Driving** chapter of this owner guide.



Loaded vehicles, with a higher center of gravity, may handle differently than unloaded vehicles. Extra precautions, such as slower speeds and increased stopping distance, should be taken when driving a heavily loaded vehicle.

Your vehicle has the capability to haul more cargo and people than most passenger cars. Depending upon the type and placement of the load, hauling cargo and people may raise the center of gravity of the vehicle.

## Driving

### Calculating the load your vehicle can carry/tow

1. Use the appropriate maximum gross combined weight rating (GCWR) chart to find the maximum GCWR for your type engine and rear axle ratio.
2. Weigh your vehicle as you customarily operate the vehicle without cargo. To obtain correct weights, try taking your vehicle to a shipping company or an inspection station for trucks.
3. Subtract your loaded vehicle weight from the maximum GCWR on the following charts. This is the maximum trailer weight your vehicle can tow and must fall below the maximum shown under maximum trailer weight on the chart.

### DRIVING THROUGH WATER

Do not drive quickly through standing water, especially if the depth is unknown. Traction or brake capability may be limited and if the ignition system gets wet, your engine may stall. Water may also enter your engine's air intake and severely damage your engine.

If driving through deep or standing water is unavoidable, proceed very slowly. Never drive through water that is higher than the bottom of the hubs (for trucks) or the bottom of the wheel rims (for cars).

Once through the water, always try the brakes. Wet brakes do not stop the vehicle as effectively as dry brakes. Drying can be improved by moving your vehicle slowly while applying light pressure on the brake pedal.

**Driving through deep water where the transmission vent tube is submerged may allow water into the transmission and cause internal transmission damage.**

### TRAILER TOWING

Trailer towing with your vehicle may require the use of a trailer tow option package.

Trailer towing puts additional loads on your vehicle's engine, transmission, axle, brakes, tires, and suspension. For your safety and to maximize vehicle performance, be sure to use the proper equipment while towing.

Follow these guidelines to ensure safe towing procedure:

- Stay within your vehicle's load limits.

- Thoroughly prepare your vehicle for towing. Refer to *Preparing to tow* in this chapter.
- Use extra caution when driving while trailer towing. Refer to *Driving while you tow* in this chapter.
- Service your vehicle more frequently if you tow a trailer. Refer to the severe duty schedule in the scheduled maintenance guide.
- Do not tow a trailer until your vehicle has been driven at least 800 km (500 miles).
- Refer to the instructions included with towing accessories for the proper installation and adjustment specifications.

Do not exceed the maximum loads listed on the Safety Compliance Certification label. For load specification terms found on the label, refer to *Vehicle loading* in this chapter. Remember to figure in the tongue load of your loaded vehicle when figuring the total weight.

<b>Trailer towing table (4x2 w/automatic transmission)</b>				
<b>GCWR (Gross Combined Weight Rating)/Trailer weights</b>				
<b>Engine</b>	<b>Rear axle ratio</b>	<b>Maximum GCWR-kg (lbs.)</b>	<b>Trailer Weight Range-kg (lbs.) 0-Maximum</b>	<b>Maximum frontal area of trailer-m<sup>2</sup> (ft<sup>2</sup>)</b>
4.0L SOHC	3.55	4 082 (9 000)	0-2 241 (0-4 940)	4.64 (50)
4.0L SOHC	3.73/4.10	4 535 (10 000)	0-2 694 (0-5 940)	4.64 (50)
5.0L	3.55	4 535 (10 000)	0-2640 (0-5 820)	4.64 (50)
5.0L	3.73	4 990 (11 000)	0-3 093 (0-6 820)	4.64 (50)
<p><b>Notes:</b> For high altitude operation, reduce GCW by 2% per 300 meters (1 000 ft) elevation. For definition of terms and instructions on calculating your vehicle's load, refer to <i>Vehicle loading</i> in this chapter. Maximum trailer weights shown. The combined weight of the completed towing vehicle and the loaded trailer must not exceed the GCWR.</p>				
<p>Towing a trailer over 1 588 kg (3 500 lbs.) requires a weight distributing hitch.</p>				

## Driving

Trailer towing table (4x4 and AWD with automatic transmission)				
GCWR (Gross Combined Weight Rating)/Trailer Weights				
Engine	Rear axle ratio	Maximum GCWR-kg (lbs.)	Trailer Weight Range-kg (lbs.) 0-Maximum	Maximum frontal area of trailer-m <sup>2</sup> (ft <sup>2</sup> )
4.0L SOHC	3.55	4 082 (9 000)	0-2 150 (0-4 740)	4.64 (50)
4.0L SOHC	3.73/4.10	4 535 (10 000)	0-2 604 (0-5 740)	4.64 (50)
5.0L	3.55	4 535 (10 000)	0-2 549 (0-5 620)	4.64 (50)
5.0L	3.73	4 990 (11 000)	0-3 003 (6 620)	4.64 (50)

**Notes:** For high altitude operation, reduce GCW by 2% per 300 meters (1 000 ft) elevation. For definition of terms and instructions on calculating your vehicle's load, refer to *Vehicle loading* in this chapter. Maximum trailer weights shown. The combined weight of the completed towing vehicle and the loaded trailer must not exceed the GCWR.

Towing a trailer over 1 588 kg (3 500 lbs.) requires a weight distributing hitch.



Do not exceed the GVWR or the GAWR specified on the certification label.



Towing trailers beyond the maximum recommended gross trailer weight exceeds the limit of the vehicle and could result in engine damage, transmission damage, structural damage, loss of control, and personal injury.

### Preparing to tow

Use the proper equipment for towing a trailer, and make sure it is properly attached to your vehicle. See your dealer or a reliable trailer dealer if you require assistance.

### **Hitches**

Do not use hitches that clamp onto the vehicle bumper. Use a load carrying hitch. You must distribute the load in your trailer so that 10% of the total weight of the trailer is on the tongue.

**Use a frame-mounted weight distributing hitch for trailers over 1 588 kg (3 500 lb).**

### **Safety chains**

Always connect the trailer's safety chains to the frame or hook retainers of the vehicle. To connect the trailer's safety chains, cross the chains under the trailer tongue and allow slack for turning corners.

If you use a rental trailer, follow the instructions that the rental agency gives to you.

**Do not attach safety chains to the bumper.**

### **Trailer brakes**

Electric brakes and manual, automatic or surge-type trailer brakes are safe if installed properly and adjusted to the manufacturer's specifications. The trailer brakes must meet local and Federal regulations.



Do not connect a trailer's hydraulic brake system directly to your vehicle's brake system. Your vehicle may not have enough braking power and your chances of having a collision greatly increase.

The braking system of the tow vehicle is rated for operation at the GVWR not GCWR.

### **Trailer lamps**

Trailer lamps are required on most towed vehicles. Make sure your trailer lamps conform to local and Federal regulations. See your dealer or trailer rental agency for proper instructions and equipment for hooking up trailer lamps.



Never connect any trailer lighting to the vehicle's taillamp circuits, because it may damage the electrical system resulting in fire. Contact your local Ford dealership for assistance in proper trailer tow wiring installation. Additional electrical equipment may be required.

## Driving

### ***Using a step bumper***

The rear bumper is equipped with an integral hitch and requires only a ball with a 19 mm (3/4 inch) shank diameter. The bumper has a 1 590 kg (3 500 lb.) trailer weight and 159 kg (350 lb.) tongue weight capability.

Use a frame-mounted weight distributing hitch for trailers over 1 590 kg (3 500 lb.).

### **Driving while you tow**

When towing a trailer:

- Ensure that you turn off your speed control. The speed control may shut off automatically when you are towing on long, steep grades.
- Consult your local motor vehicle speed regulations for towing a trailer.
- Use a lower gear when towing up or down steep hills. This will eliminate excessive downshifting and upshifting for optimum fuel economy and transmission cooling.
- Anticipate stops and brake gradually.

**Exceeding the GCWR rating may cause internal transmission damage and void your warranty coverage.**

### ***Servicing after towing***

If you tow a trailer for long distances, your vehicle will require more frequent service intervals. Refer to your scheduled maintenance guide for more information.

### **Trailer towing tips**

- Practice turning, stopping and backing up before starting on a trip to get the feel of the vehicle trailer combination. When turning, make wider turns so the trailer wheels will clear curbs and other obstacles.
- Allow more distance for stopping with a trailer attached.
- The trailer tongue weight should be 10% of the loaded trailer weight.
- After you have traveled 80 km (50 miles), thoroughly check your hitch, electrical connections and trailer wheel lug nuts.
- When stopped in traffic for long periods of time in hot weather, place the gearshift in P (Park) and increase idle speed. This aids engine cooling and air conditioner efficiency.
- Vehicles with trailers should not be parked on a grade. If you must park on a grade, place wheel chocks under the trailer's wheels.

### **Launching or retrieving a boat**

When backing down a ramp during boat launching or retrieval,

- Do not allow the static water level to rise above the bottom edge of the rear bumper and
- Do not allow waves to break higher than 15 cm (6 inches) above the bottom edge of the rear bumper.

Exceeding these limits may allow water to enter critical vehicle components, adversely affecting driveability, emissions, reliability and causing internal transmission damage.

Replace the rear axle lubricant anytime the axle has been submerged in water. Rear axle lubricant quantities are not to be checked or changed unless a leak is suspected or repair required.

Disconnect the wiring to the trailer before backing the trailer into the water. Reconnect the wiring to the trailer after the trailer is removed from the water.

### **Recreational towing (all wheels on the ground) (Neutral tow kit accessory)**

On vehicles equipped with a two-speed transfer case, an accessory is available that allows you to tow your vehicle, behind another vehicle, with all the wheels on the ground. Contact your dealer for more details. Do not tow your vehicle with all wheels on the ground unless you install the neutral tow kit as vehicle damage may occur.

Follow these guidelines for your specific powertrain combination to tow your vehicle with all four wheels on the ground (such as behind a recreational vehicle).

These guidelines are designed to ensure that your transmission is not damaged due to insufficient lubrication.

#### ***All Rear Wheel Drive (RWD) vehicles***

This applies to all cars and 4x2 trucks/sport utilities with rear wheel drive capability.

An example of recreational towing is towing your vehicle behind a Motorhome. The following recreational towing guidelines are designed to ensure that your transmission is not damaged.

- Place the transmission in N (Neutral).
- Maximum speed is 56 km/h (35 mph).
- Maximum distance is 80 km (50 miles).

## Driving

If a distance of 80 km (50 miles) or a speed of 56 km/h (35 mph) must be exceeded, you must disconnect the driveshaft. Ford recommends the driveshaft be removed/installed only by a qualified technician. See your local dealer for driveshaft removal/installation.

**Improper removal/installation of the driveshaft can cause transmission fluid loss, damage to the driveshaft and internal transmission components.**

### ***RWD vehicles with 4x4 electronic shift transfer case or All Wheel Drive (AWD) vehicles with automatic transmissions***

Regarding recreational towing or having your vehicle towed, 4x4 vehicles with electronic shift on the fly and AWD vehicles cannot be towed with any wheels on the ground (with the exception of moving it as a disabled vehicle off the road out of traffic).

## LUGGAGE RACK

Maximum load is 90 kg (200 lbs), evenly distributed. If it is not possible to distribute the load, position it as far rearward as possible. Adjustable tie down loops must be used to secure the load.

To adjust cross-bar position:

1. Loosen the thumbwheel at both ends of the cross-bar (both cross-bars are adjustable).
2. Slide the cross-bar to the desired location.
3. Tighten the thumbwheel at both ends of the cross-bar.

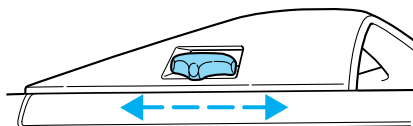

To remove the cross-bar assembly from the roof rack side rails:

1. Loosen the thumbwheel at both ends of the cross-bar (both cross-bars are adjustable).
2. Slide the cross-bar to the end of the rail.
3. Use a long, flat object in order to depress the tongue in the endcaps on both sides of the cross-bar.
4. Slide the assemblies off the end.

To reinstall the cross-bar assembly to the roof rack side rails:

1. Slide the cross-bar assemblies over the end cap tongue and into the side rails.
2. Tighten thumbwheel at both ends of the cross-bar.



## Roadside emergencies

### GETTING ROADSIDE ASSISTANCE

To fully assist you should you have a vehicle concern, Ford offers a complimentary roadside assistance program. This program is separate from the New Vehicle Limited Warranty. The service is available:

- 24-hours, seven days a week
- for the Basic warranty period (Canada) or New Vehicle Limited Warranty period (U.S.) of three years or 60,000 km (36,000 miles), whichever comes first on Ford and Mercury vehicles, and four years or 80,000 km (50,000 miles) on Lincoln vehicles

Roadside assistance will cover:

- changing a flat tire
- jump-starts
- lock-out assistance
- fuel delivery
- towing of your disabled vehicle to the nearest Ford dealership, or your selling dealer if within 25 kms (15.5 miles) of the nearest Ford Dealership (one tow per disablement). Even non-warranty related tows, like accidents or getting stuck in the mud or snow, are covered (some exclusions apply, such as impound towing or repossession).

### Using roadside assistance

Complete the roadside assistance identification card and place it in your wallet for quick reference. In the United States, this card is found in the Owner Guide portfolio in the glove compartment in Ford vehicles and is mailed to you if you own a Mercury or Lincoln. In Canada, it is found in the Roadside Assistance book in the glove compartment.

To receive roadside assistance in the United States for Ford or Mercury vehicles, call 1-800-241-3673 or if you own a Lincoln vehicle, call 1-800-521-4140. In Canada call 1-800-665-2006.

Should you need to arrange roadside assistance for yourself, Ford will reimburse a reasonable amount. To obtain information about reimbursement, call 1-800-241-3673 in the United States for Ford or Mercury vehicles; or if you own a Lincoln vehicle, call 1-800-521-4140. Call 1-800-665-2006 in Canada.

## Roadside emergencies

### Roadside coverage beyond basic warranty

In the United States, you may purchase additional roadside assistance coverage beyond this period through the Ford Auto Club by contacting your Ford or Lincoln Mercury dealer.

Similarly in Canada, you may purchase additional coverage beyond the basic coverage period by consulting the Ford Roadside Assistance Club brochure or by calling 1-877-294-CLUB (1-877-894-2582).

### HAZARD FLASHER

Use only in an emergency to warn traffic of vehicle breakdown, approaching danger, etc. The hazard flashers can be operated when the ignition is off.

- The hazard lights control is located on top of the steering column.
- Depress hazard lights control to activate all hazard flashers simultaneously.
- Depress control again to turn the flashers off.

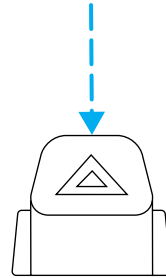

### RESETTING THE FUEL PUMP SHUT-OFF SWITCH FUEL RESET

The fuel pump shut-off switch is a device intended to stop the electric fuel pump when your vehicle has been involved in a substantial jolt.

After a collision, if the engine cranks but does not start, the fuel pump shut-off switch may have been activated.

## Roadside emergencies

The fuel pump shut-off switch is located in the passenger's foot well, by the kick panel.

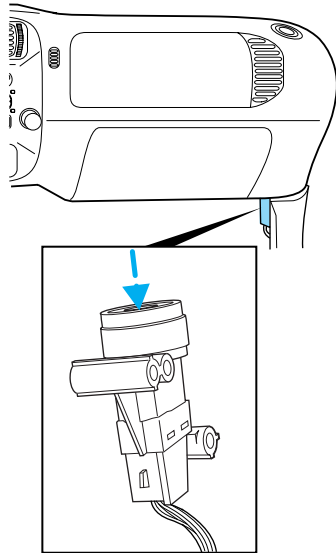

Use the following procedure to reset the fuel pump shut-off switch.

1. Turn the ignition to the OFF position.
2. Check the fuel system for leaks.
3. If no fuel leak is apparent, reset the fuel pump shut-off switch by pushing in on the reset button.
4. Turn the ignition to the ON position. Pause for a few seconds and return the key to the OFF position.
5. Make a further check for leaks in the fuel system.

## FUSES AND RELAYS

### Fuses

If electrical components in the vehicle are not working, a fuse may have blown. Blown fuses are identified by a broken wire within the fuse. Check the appropriate fuses before replacing any electrical components.

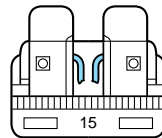

## Roadside emergencies



Always replace a fuse with one that has the specified amperage rating. Using a fuse with a higher amperage rating can cause severe wire damage and could start a fire.

### Standard fuse amperage rating and color

COLOR					
Fuse Rating	Mini Fuses	Standard Fuses	Maxi Fuses	Cartridge Maxi Fuses	Fuse Link Cartridge
2A	Grey	Grey	—	—	—
3A	Violet	Violet	—	—	—
4A	Pink	Pink	—	—	—
5A	Tan	Tan	—	—	—
7.5A	Brown	Brown	—	—	—
10A	Red	Red	—	—	—
15A	Blue	Blue	—	—	—
20A	Yellow	Yellow	Yellow	Blue	Blue
25A	Natural	Natural	—	—	—
30A	Green	Green	Green	Pink	Pink
40A	—	—	Orange	Green	Green
50A	—	—	Red	Red	Red
60A	—	—	Blue	—	Yellow
70A	—	—	Tan	—	Brown
80A	—	—	Natural	—	Black

## Roadside emergencies

### Passenger compartment fuse panel

The fuse panel is located on the left hand side of the instrument panel facing the driver's side door. Pull the panel cover outward to access the fuses.

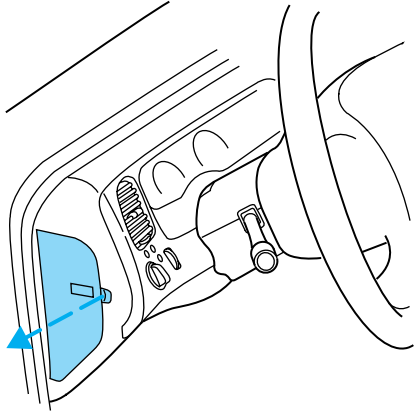

To remove a fuse use the fuse puller tool provided on the fuse panel cover.

## Roadside emergencies

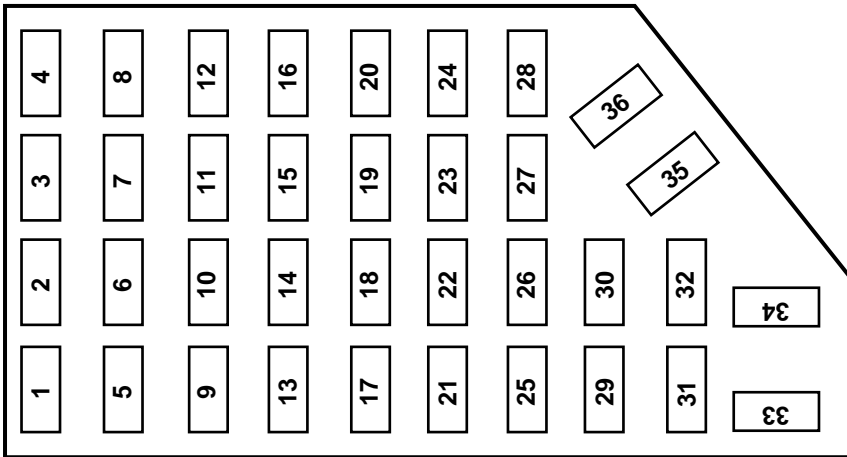

The fuses are coded as follows:

Fuse/ Relay Location	Fuse Amp Rating	Passenger Compartment Fuse Panel Description
1	7.5A	Power Mirror Switch, Power Antenna, Memory Seat
2	7.5A	Blower Motor Relay, Air Bag Diagnostic Monitor
3	7.5A	Left Stop/Turn Trailer Tow Connector
4	10A	Left Headlamp
5	10A	Data Link Connector (DLC)
6	7.5A	Rear Blower Motor (Without EATC)
7	7.5A	Right Stop/Turn Trailer Tow Connector
8	10A	Right Headlamp, Foglamp Relay
9	7.5A	Brake Pedal Position Switch
10	7.5A	Speed Control/Amplifier Assembly, Generic electronic Module (GEM), Shift Lock Actuator, Blend Door Actuator, A/C - Heater Assembly, Flasher, Overhead Console, Load Leveling Module

## Roadside emergencies

<b>Fuse/ Relay Location</b>	<b>Fuse Amp Rating</b>	<b>Passenger Compartment Fuse Panel Description</b>
11	7.5A	Instrument Cluster
12	7.5A	Washer Pump Relay, Rear Washer Pump Relay
13	20A	Brake Pedal Position Switch, Brake Pressure Switch
14	10A	4 Wheel Anti-Lock Brake System (4WABS) Module, 4WABS Main Relay
15	7.5A	Instrument Cluster
16	30A	Windshield Wiper Motor, Wiper Hi-Lo Relay, Wiper Run/Park Relay
17	25A	Cigar Lighter
18	25A	Drivers Unlock Relay, All Unlock Relay, All Lock Relay, Power Seats
19	25A	PCM Power Diode
20	7.5A	RAP Module, Generic Electronic Module (GEM), Radio
21	15A	Flasher (Hazard)
22	20A	Auxiliary Power Socket
23	—	Not Used
24	7.5A	Clutch Pedal Position (CPP) Switch, Starter Interrupt Relay, Anti-Theft
25	7.5A	Generic Electronic Module (GEM), Instrument Cluster, Securi-Lock
26	10A	Battery Saver Relay, Electronic Shift Relay, Interior Lamp Relay, Electronic Shift Control Module
27	15A	DRL, Backup Lamps Switch, DTR Sensor, Electric Shift
28	7.5A	Generic Electronic Module (GEM), Radio, Memory Seat
29	25A	Radio
30	15A	Park Lamp/Trailer Tow Relay
31	—	Not Used

## Roadside emergencies

Fuse/Relay Location	Fuse Amp Rating	Passenger Compartment Fuse Panel Description
32	10A	Heated Mirror
33	15A	Headlamps, Daytime Running Lamps (DRL) Module, Instrument Cluster
34	7.5A	Rear Integrated Control Panel, CD
35	7.5A	Rear Blower Motor (w/EATC)
36	7.5A	EATC Memory, CD, Rear Integrated Control Panel, Memory Seat, Message Center

### Power distribution box

The power distribution box is located in the engine compartment. The power distribution box contains high-current fuses that protect your vehicle's main electrical systems from overloads.

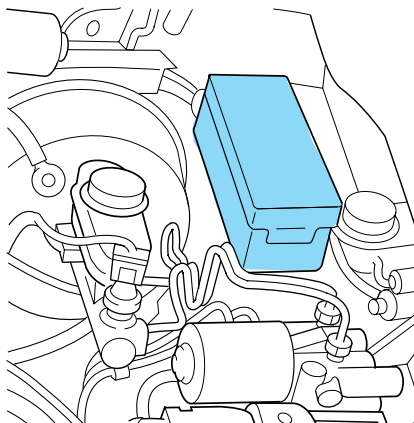

Always disconnect the battery before servicing high current fuses.



Always replace the cover to the Power Distribution Box before reconnecting the battery or refilling fluid reservoirs.

If the battery has been disconnected and reconnected, refer to the *Battery* section of the *Maintenance and care* chapter.



## Roadside emergencies

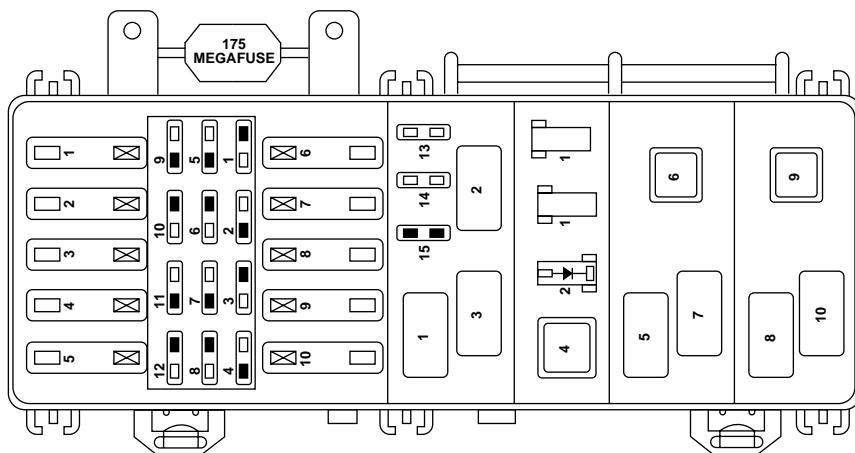

The high-current fuses are coded as follows:

Fuse/ Relay Location	Fuse Amp Rating	Power Distribution Box Description
1	60A**	I/P Fuse Panel fuses 1, 9, and 13
2	40A**	Blower Motor Relay
3	50A**	4 Wheel Anti-Lock Brake System (4WABS) Module
4	30A**	Power Moon Roof, Accessory Relay Delay
5	50A**	Ignition Switch, Starter Relay
6	20A**	Transfer Case Relay
7	—	Not Used
8	20A**	Air Suspension
9	40A**	Air Suspension
10	30A**	PCM Power Relay
1	10A*	A/C Relay
2	30A*	Heated Seats
3	30A*	Heated Backlight
4	15A*	Fog Lamps and Daytime Running Lamps

## Roadside emergencies

<b>Fuse/ Relay Location</b>	<b>Fuse Amp Rating</b>	<b>Power Distribution Box Description</b>
5	—	Not Used
6	10A*	Powertrain Control Module
7	30A*	4 Wheel Anti-Lock System (4WABS) Module
8	15A*	Rear Wiper Motor
9	20A*	Fuel Pump Relay and RAP Module
10	15A*	Horn Relay
11	15A*	Parklamps Relay and Mainlight Switch
12	30A*	Mainlight Switch and Multifunction Switch
13	15A*	Heated Oxygen Sensor, EGR Vacuum Regulator, EVR Solenoid, Camshaft Position (CMP) Sensor, Canister Vent Solenoid
14	30A*	Generator/Voltage Regulator
15	—	Not Used
1	—	Wiper Park Relay
2	—	A/C Relay
3	—	Wiper High/Low Relay
4	—	PCM Power Relay
5	—	Fuel Pump Relay
6	—	Starter Relay
7	—	Horn Relay
8	—	Rear Wipe Down Relay
9	—	Blower Motor Relay
10	—	Rear Wipe Up Relay
1	—	Not Used
1	—	DRL Diode
2	—	Electronic Engine Controls Diode
* Mini Fuses ** Maxi Fuses		

## Roadside emergencies

### CHANGING THE TIRES

If you get a flat tire while driving, do not apply the brake heavily. Instead, gradually decrease your speed. Hold the steering wheel firmly and slowly move to a safe place on the side of the road.

#### Spare tire information

Your vehicle is equipped with a 15" spare tire that must be used for emergencies only. Vehicles equipped with 16" tires have a 16" spare tire. The 15" spare tire is not as wide as a regular tire and is designed for emergency use only. Replace this tire with a full-size tire as soon as possible. The 16" spare tire is not equipped with wheel ornaments. The wheel ornaments from the original wheel/tire may be used on the spare.

**If your vehicle is equipped with 4WD or AWD, a spare tire of a different size than the road tires should not be used. Such a tire could result in damage to driveline components and make the vehicle difficult to control.**

#### Location of the spare tire and tools

The spare tire and tools for your vehicle are stowed in the following locations:

Tool	Location
Spare tire	Under the vehicle, just in front of the rear bumper
Jack, lug nut wrench	Left rear quarter panel behind interior access cover
Jack handle	On the lower rear seat base

#### Removing the spare tire

1. Insert the jack handle into the rear bumper opening.

The handle will stop moving and forward resistance to turning will be felt when properly engaged.

2. Turn the handle counterclockwise until tire is lowered to the ground, the tire can be slid rearward and the cable is slightly slack.

3. Remove the retainer from the spare tire.

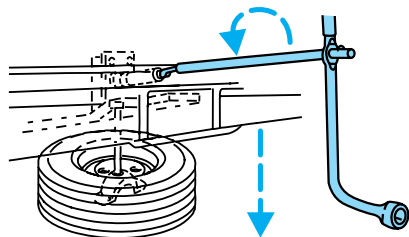

## Roadside emergencies

### Stowing the spare tire

1. Lay the tire on the ground with the valve stem facing up.
2. Slide the wheel under the vehicle and install the retainer through the wheel center.
3. Turn the jack handle clockwise until the tire is raised to its original position underneath the vehicle. The jack handle ratchets when the tire is raised to the stowed position. It will not allow you to overtighten.

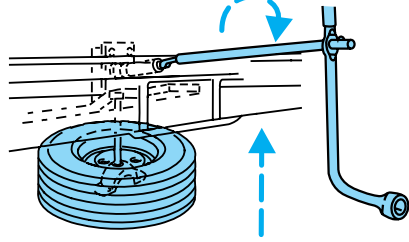

### Tire change procedure

 To prevent the vehicle from moving when you change a tire, be sure the parking brake is set, then block (in both directions) the wheel that is diagonally opposite (other side and end of the vehicle) to the tire being changed.

 If the vehicle slips off the jack, you or someone else could be seriously injured.

*Refer to the instruction sheet for detailed tire change instructions.*

1. Park on a level surface, activate hazard flashers and set the parking brake.
2. Place gearshift lever in P (Park) and turn engine OFF.

 When one of the rear wheels is off the ground, the transmission alone will not prevent the vehicle from moving or slipping off the jack, even if the transmission is in P (Park).

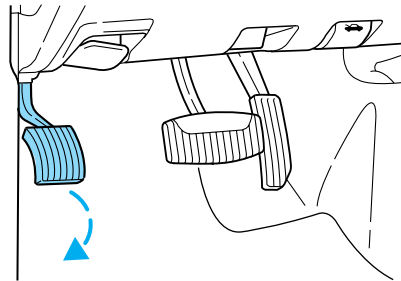

## Roadside emergencies

3. Block the diagonally opposite wheel.
4. Use the tip of the lug wrench to remove any wheel trim.

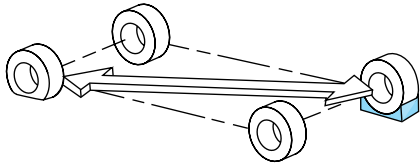

5. Loosen each wheel lug nut, but do not remove them until the wheel is raised off the ground.

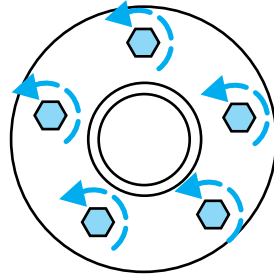

On vehicles equipped with Air Suspension, turn OFF the Air Suspension switch prior to jacking, hoisting or towing your vehicle.

6. Turn OFF the air suspension switch (if equipped). Refer to *Air suspension system* in the *Driving* chapter.

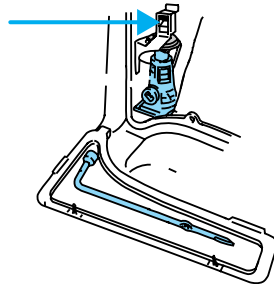

7. Position the jack according to the following guides and turn the jack handle clockwise until the tire is a maximum of 25 mm (1 inch) off the ground.

## Roadside emergencies

- Front

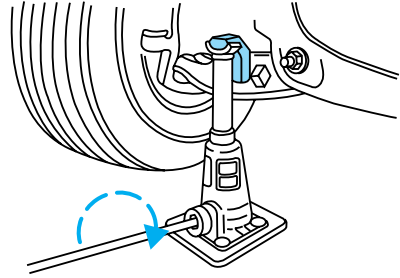

- Rear

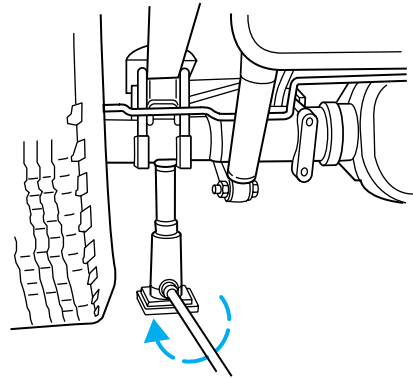

To lessen the risk of personal injury, do not put any part of your body under the vehicle while changing a tire. Do not start the engine when your vehicle is on the jack. The jack is only meant for changing the tire.

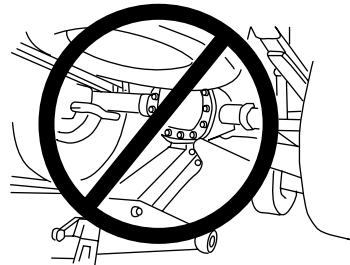

- **Never use the front or rear differential as a jacking point.**

8. Remove the lug nuts with the lug wrench.

9. Replace the flat tire with the spare tire, making sure the valve stem is facing outward. Reinstall the lug nuts, cone side in, until the wheel is snug against the hub. Do not fully tighten the lug nuts until the wheel has been lowered.

## Roadside emergencies

- Lower the wheel by turning the jack handle counterclockwise.
- Remove the jack and fully tighten the lug nuts in the order shown.

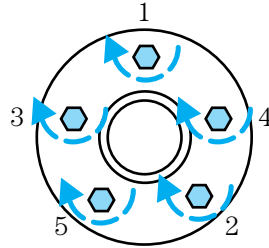

- Stow the flat tire, jack and lug wrench. Make sure the jack is fastened so it does not rattle when you drive.
- Turn ON the air suspension switch (if equipped).
- Unblock the wheels.

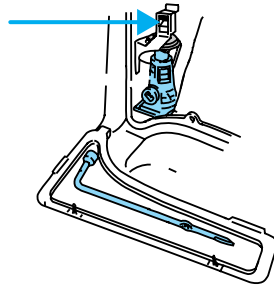

## JUMP STARTING YOUR VEHICLE



The gases around the battery can explode if exposed to flames, sparks, or lit cigarettes. An explosion could result in injury or vehicle damage.



Do not push start your vehicle. You could damage the catalytic converter.



Batteries contain sulfuric acid which can burn skin, eyes, and clothing, if contacted.

**Do not attempt to push start your vehicle. Automatic transmissions do not have push-start capability.**

## Roadside emergencies

### Preparing your vehicle

When the battery is disconnected or a new battery is installed, the transmission must relearn its adaptive strategy. As a result of this, the transmission may shift firmly. This operation is considered normal and will not effect function or durability of the transmission. Over time, the adaptive learning process will fully update transmission operation to its optimum shift feel.

1. **Use only a 12-volt supply to start your vehicle.**
2. Do not disconnect the battery of the disabled vehicle as this could damage the vehicle's electrical system.
3. Park the booster vehicle close to the hood of the disabled vehicle making sure the two vehicles **do not** touch. Set the parking brake on both vehicles and stay clear of the engine cooling fan and other moving parts.
4. Check all battery terminals and remove any excessive corrosion before you attach the battery cables. Ensure that vent caps are tight and level.
5. Turn the heater fan on in both vehicles to protect any electrical surges. Turn all other accessories off.

### Connecting the jumper cables

1. Connect the positive (+) booster cable to the positive (+) terminal of the discharged battery.

**Note:** In the illustrations, *lightning bolts* are used to designate the assisting (boosting) battery.

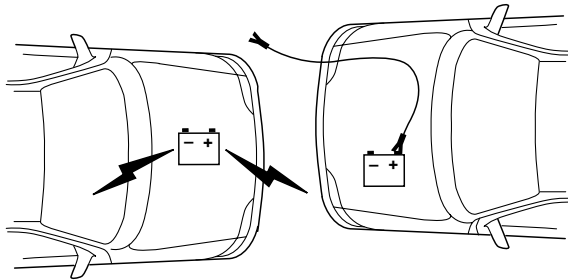

2. Connect the other end of the positive (+) cable to the positive (+) terminal of the assisting battery.



## Roadside emergencies

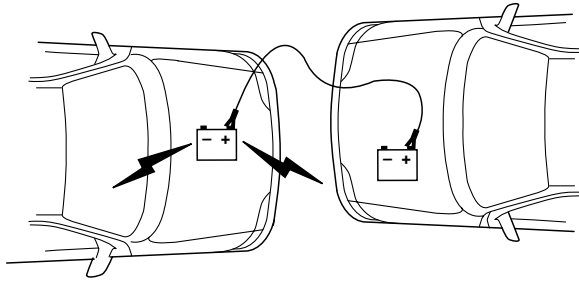

3. Connect the negative (-) cable to the negative (-) terminal of the assisting battery.

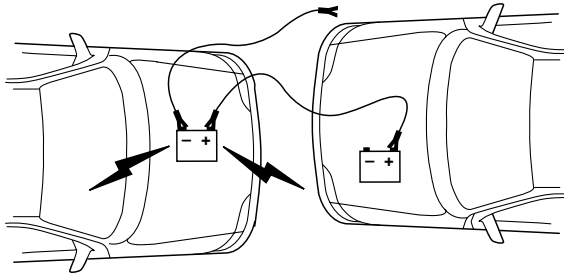

4. Make the final connection of the negative (-) cable to an exposed metal part of the stalled vehicle's engine, away from the battery and the carburetor/fuel injection system.

**Do not** use fuel lines, engine rocker covers or the intake manifold as *grounding* points.



Do not connect the end of the second cable to the negative (-) terminal of the battery to be jumped. A spark may cause an explosion of the gases that surround the battery.

## Roadside emergencies

- Engines except 4.0L SOHC

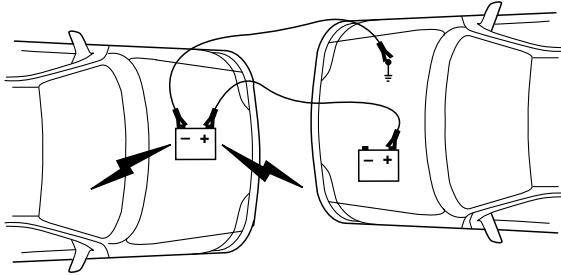

- 4.0L SOHC

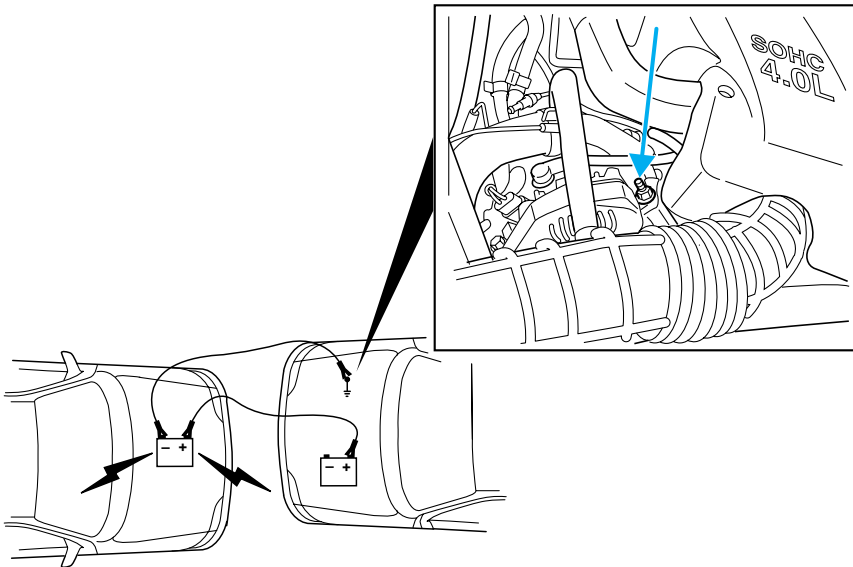

5. Ensure that the cables are clear of fan blades, belts, moving parts of both engines, or any fuel delivery system parts.

## Roadside emergencies

### Jump starting

1. Start the engine of the booster vehicle and run the engine at moderately increased speed.
2. Start the engine of the disabled vehicle.
3. Once the disabled vehicle has been started, run both engines for an additional three minutes before disconnecting the jumper cables.

### Removing the jumper cables

**Remove the jumper cables in the reverse order that they were connected.**

1. Remove the jumper cable from the *ground* metal surface.
- Engines except 4.0L SOHC

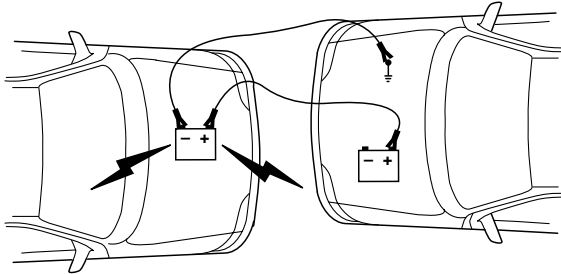

## Roadside emergencies

- 4.0L SOHC

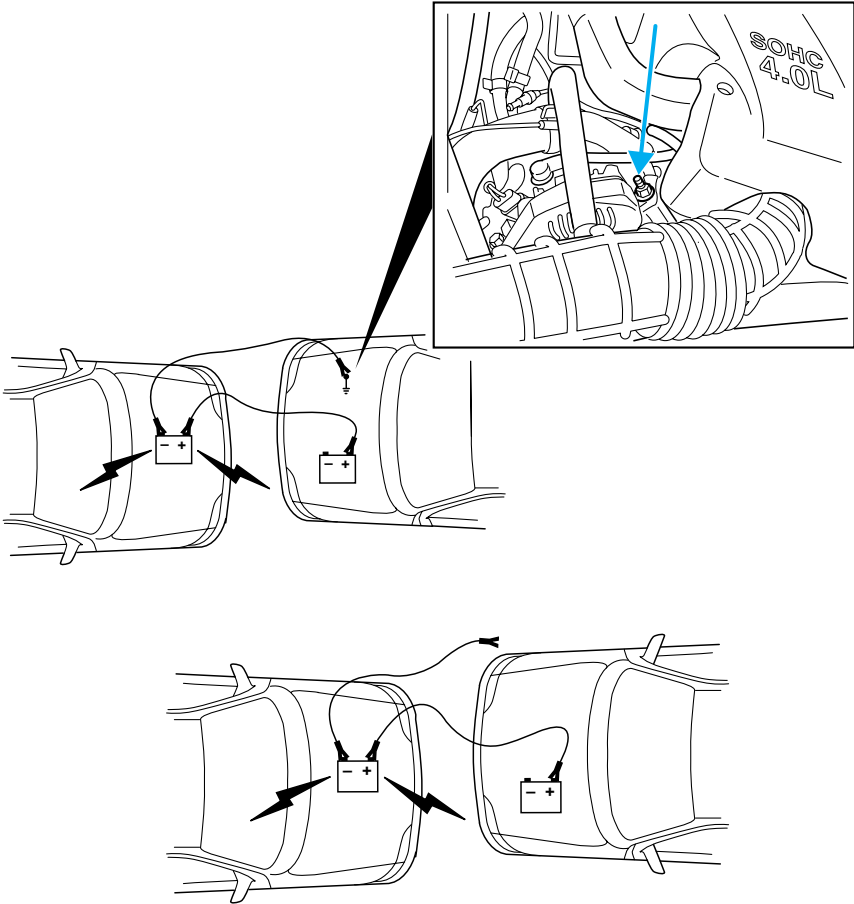

2. Remove the jumper cable on the negative (-) connection of the booster vehicle's battery.

## Roadside emergencies

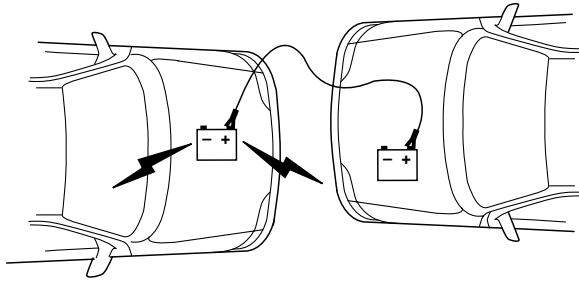

3. Remove the jumper cable from the positive (+) terminal of the booster vehicle's battery.

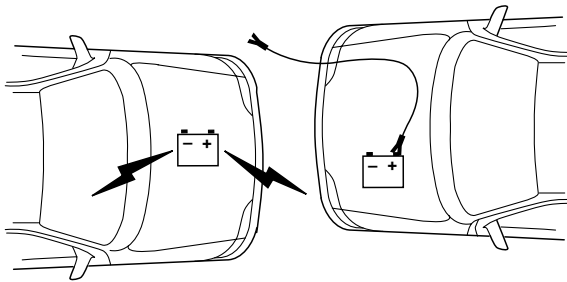

4. Remove the jumper cable from the positive (+) terminal of the disabled vehicle's battery.

After the disabled vehicle has been started and the jumper cables removed, allow it to idle for several minutes so the engine computer can *relearn* its idle conditions.

## Roadside emergencies

### WRECKER TOWING

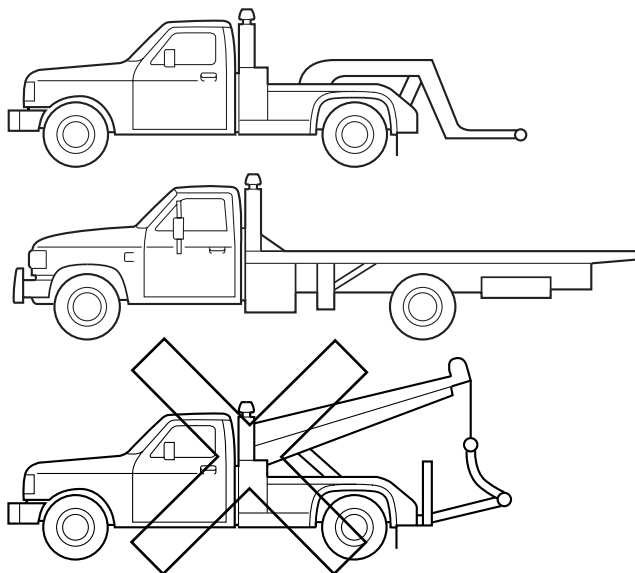

If you need to have your vehicle towed, contact a professional towing service or, if you are a member, your roadside assistance center.

It is recommended that your vehicle be towed with a wheel lift or flatbed equipment. Do not tow with a slingbelt. Ford Motor Company has not approved a slingbelt towing procedure.

If equipped with air suspension, the air suspension control must be turned to the OFF position.

On 4x2 vehicles, it is acceptable to tow the vehicle with the front wheels on the ground (without dollies) and the rear wheels off the ground.

On 4x4 vehicles, it is recommended that your vehicle be towed with a wheel lift and dollies or flatbed equipment with all the wheels off the ground.

**If the vehicle is towed by other means or incorrectly, vehicle damage may occur.**

Ford Motor Company provides a towing manual for all authorized tow truck operators. Have your tow truck operator refer to this manual for proper hook-up and towing procedures for your vehicle.

## Maintenance and care

### SERVICE RECOMMENDATIONS

To help you service your vehicle:

- We highlight do-it-yourself items in the engine compartment for easy location.
- We provide a scheduled maintenance guide which makes tracking routine service easy.

If your vehicle requires professional service, your dealership can provide the necessary parts and service. Check your “Warranty Guide” to find out which parts and services are covered.

Use only recommended fuels, lubricants, fluids and service parts conforming to specifications. Motorcraft parts are designed and built to provide the best performance in your vehicle.

### PRECAUTIONS WHEN SERVICING YOUR VEHICLE

Be especially careful when inspecting or servicing your vehicle.

- Do not work on a hot engine.
- When the engine is running, make sure that loose clothing, jewelry or long hair does not get caught up in moving parts.
- Do not work on a vehicle with the engine running in an enclosed space, unless you are sure you have enough ventilation.
- Keep all lit cigarettes, open flames and other lit material away from the battery and all fuel related parts.

If you disconnect the battery, the engine must “relearn” its idle conditions before your vehicle will drive properly, as explained in *Battery* in this chapter.

#### Working with the engine off

1. Set the parking brake and ensure the gearshift is securely latched in P (Park).
2. Turn off the engine and remove the key.
3. Block the wheels to prevent the vehicle from moving unexpectedly.

#### Working with the engine on

1. Set the parking brake and ensure the gearshift is securely latched in P (Park).
2. Block the wheels to prevent the vehicle from moving unexpectedly.

## Maintenance and care



Do not start your engine with the air cleaner removed and do not remove it while the engine is running.

### OPENING THE HOOD

1. Inside the vehicle, pull the hood release handle located under the steering column on the instrument panel.

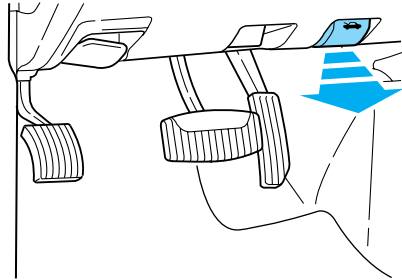

2. Go to the front of the vehicle and release the auxiliary latch that is located in the center between the hood and the grill.

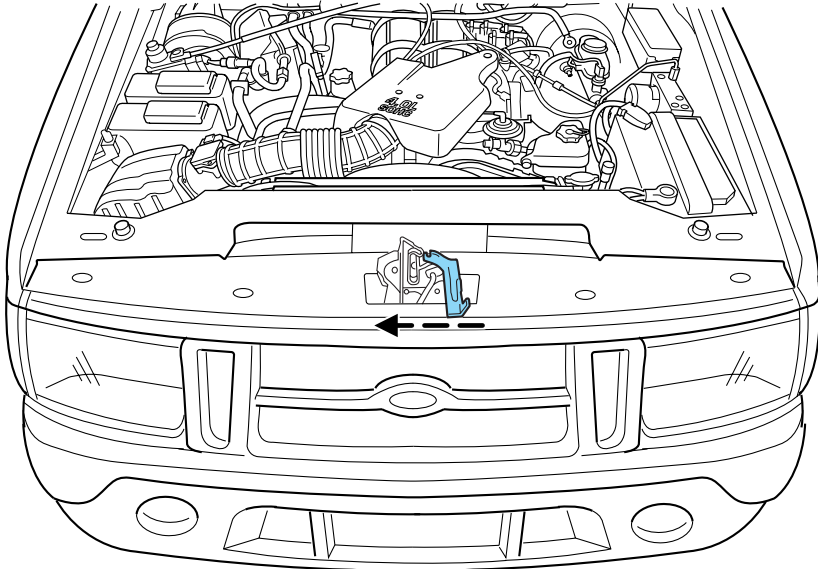

3. Lift the hood until the lift cylinders hold it open.



## Maintenance and care

### IDENTIFYING COMPONENTS IN THE ENGINE COMPARTMENT

#### 4.0L SOHC V6 engine

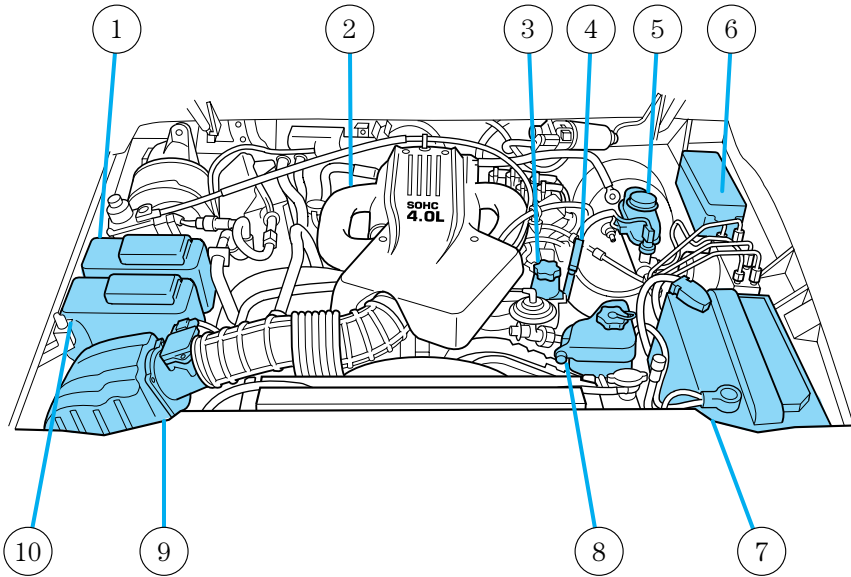

1. Windshield washer fluid reservoir
2. Automatic transmission fluid dipstick
3. Engine oil filler cap
4. Engine oil dipstick
5. Brake fluid reservoir
6. Power distribution box
7. Battery
8. Power steering fluid reservoir
9. Air filter assembly
10. Engine coolant reservoir

## Maintenance and care

### 5.0L V8 engine

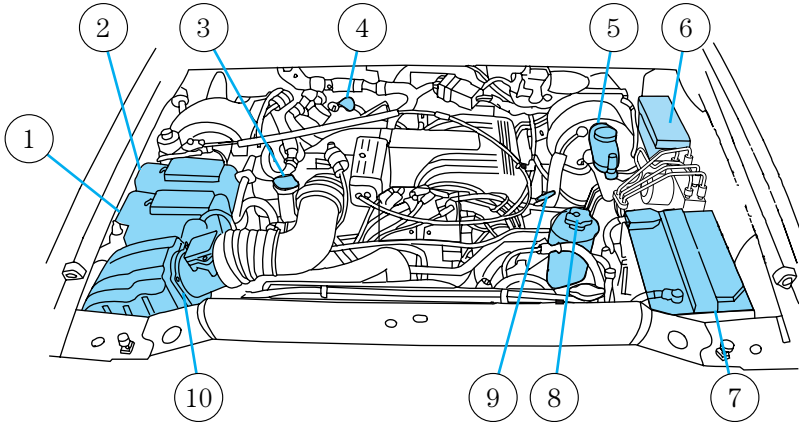

1. Engine coolant reservoir
2. Windshield washer fluid reservoir
3. Engine oil filler cap
4. Automatic transmission fluid dipstick
5. Brake fluid reservoir
6. Power distribution box
7. Battery
8. Power steering fluid reservoir
9. Engine oil dipstick
10. Air filter assembly

### ENGINE OIL

#### Checking the engine oil

Refer to the scheduled maintenance guide for the appropriate intervals for checking the engine oil.

1. Make sure the vehicle is on level ground.
2. Turn the engine off and wait a few minutes for the oil to drain into the oil pan.

## Maintenance and care

3. Set the parking brake and ensure the gearshift is securely latched in P (Park).
  4. Open the hood. Protect yourself from engine heat.
  5. Locate and carefully remove the engine oil level indicator (dipstick).
- 4.0L V6 engines

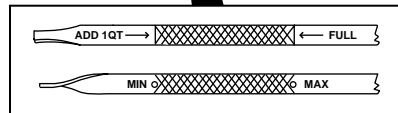
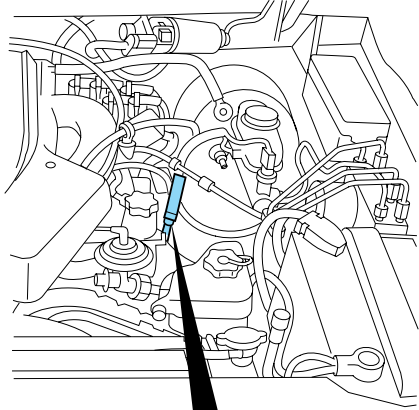

- 5.0L V8 engine

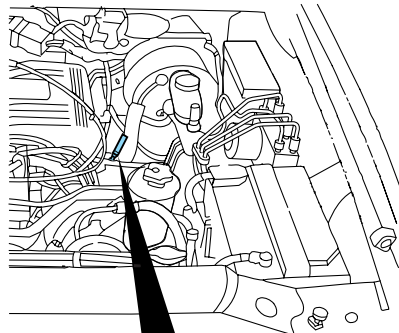

## Maintenance and care

6. Wipe the indicator clean. Insert the indicator fully, then remove it again.

- If the oil level is **between the ADD and FULL marks** or **between the MIN and MAX marks (depending on application)**, the oil level is acceptable. **DO NOT ADD OIL.**
- If the oil level is below the ADD mark or MIN mark, add enough oil to raise the level within the ADD-FULL range or MIN-MAX range.

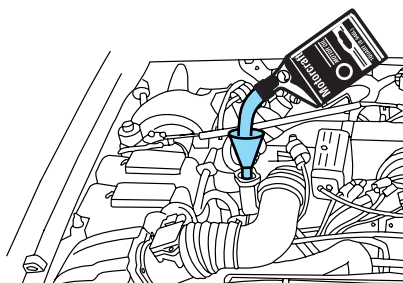

- Oil levels above the letter F in FULL or the MAX mark may cause engine damage. Some oil must be removed from the engine by a service technician.

7. Put the indicator back in and ensure it is fully seated.

### Adding engine oil

1. Check the engine oil. For instructions, refer to *Checking the engine oil* in this chapter.
2. If the engine oil level is not within the normal range, add only certified engine oil of the recommended viscosity. Remove the engine oil filler cap and use a funnel to pour the engine oil into the opening.
3. Recheck the engine oil level. Make sure the oil level is not above the MAX mark or the letter F in FULL on the engine oil level indicator (dipstick).
4. Install the indicator and ensure it is fully seated.
5. Fully install the engine oil filler cap by turning the filler cap clockwise until three clicks can be heard.

**To avoid possible oil loss, DO NOT operate the vehicle with the engine oil level indicator and/or the engine oil filler cap removed.**

## Maintenance and care

### Engine Oil Recommendations

#### 5.0L Engine

Look for this certification trademark.

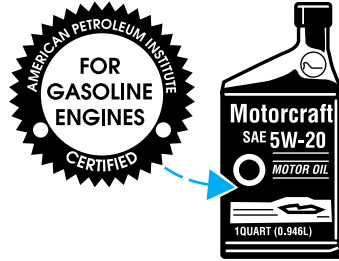

#### ***SAE 5W-20 engine oil is recommended.***

Only use oils “Certified For Gasoline Engines” by the American Petroleum Institute (API). Use Motorcraft (Part: XO-5W20-QSP in U.S.) or an equivalent oil meeting Ford Specification WSS-M2C153-H. **SAE 5W-20 oil provides optimum fuel economy and durability performance meeting all requirements for your vehicle’s engine.**

Change your engine oil and filter according to the appropriate schedule listed in the scheduled maintenance guide.

Do not use supplemental engine oil additives, oil treatments or engine treatments. They are unnecessary and could, under certain conditions, lead to engine damage which is not covered by your warranty.

#### 4.0L Engine

Look for this certification trademark.

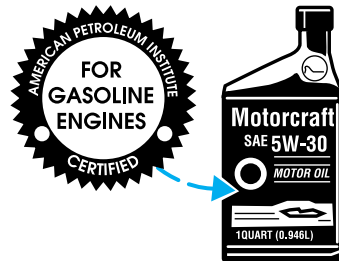

## Maintenance and care

### ***SAE 5W-30 engine oil is recommended.***

Only use oils “Certified For Gasoline Engines” by the American Petroleum Institute (API). Use Motorcraft (Part: XO-5W30-QSP in U.S.) or an equivalent oil meeting Ford Specification WSS-M2C153-G.

Do not use supplemental engine oil additives, oil treatments or engine treatments. They are unnecessary and could, under certain conditions, lead to engine damage which is not covered by your warranty.

Change your engine oil according to the appropriate schedule listed in the scheduled maintenance guide.

### **Engine Oil Filter Recommendation**

Change your engine oil filter according to the appropriate schedule listed in the scheduled maintenance guide. Ford production and aftermarket (Motorcraft) oil filters are designed for added engine protection and long life. If a replacement oil filter is used that does not meet Ford Material and design specifications, start-up engine noises or knock may be experienced.

It is recommended you use the appropriate Motorcraft oil filter (or another brand meeting Ford specifications) for your engine.

## **BRAKE FLUID (⚠)**

### **Checking and adding brake fluid**

Brake fluid should be checked and refilled as needed. Refer to the scheduled maintenance guide for the service interval schedules.

1. Clean the reservoir cap before removal to prevent dirt or water from entering the reservoir.

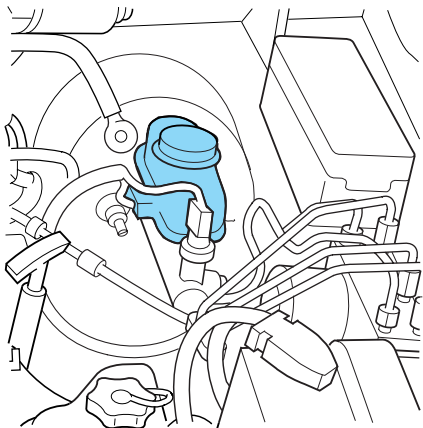

## Maintenance and care

2. Visually inspect the fluid level.
3. If necessary, add brake fluid from a clean un-opened container until the level reaches MAX. Do not fill above this line.
4. Use only a DOT 3 brake fluid certified to meet Ford specifications. Refer to *Lubricant specifications* in the *Capacities and specifications* chapter.

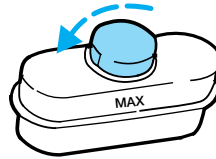

Brake fluid is toxic. If brake fluid contacts the eyes, flush eyes with running water for 15 minutes. Seek medical attention if irritation persists. If taken internally, drink water and induce vomiting. Seek medical attention immediately.



If you use a brake fluid that is not DOT 3, you will cause permanent damage to your brakes.



Do not let the reservoir for the master cylinder run dry. This may cause the brakes to fail.

## WINDSHIELD WASHER FLUID

### Checking and adding washer fluid

Check the washer fluid whenever you stop for fuel. The reservoir is highlighted with a  symbol.

If the level is low, add enough fluid to fill the reservoir. In very cold weather, do not fill the reservoir all the way.

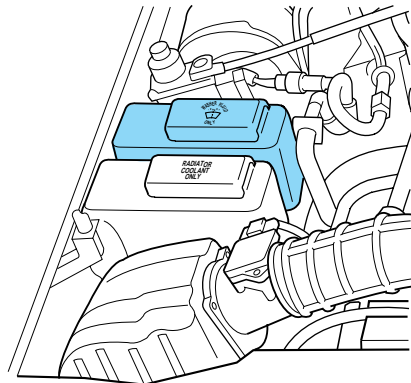

## Maintenance and care

Only use a washer fluid that meets Ford specifications. Refer to *Lubricant specifications* in the *Capacities and specifications* chapter. State or local regulations on volatile organic compounds may restrict the use of methanol, a common windshield washer antifreeze additive. Washer fluids containing non-methanol antifreeze agents should be used only if they provide cold weather protection without damaging the vehicle's paint finish, wiper blades or washer system.



Do not put washer fluid in the engine coolant reservoir. Washer fluid placed in the cooling system may harm engine and cooling system components.

### Checking and adding washer fluid for the liftgate

Washer fluid for the liftgate is supplied by the same reservoir as the windshield.

### ENGINE COOLANT

#### Checking engine coolant

Your engine's cooling system has been factory-filled with a 50/50 mixture of distilled water and Ford G05 Engine Coolant per Ford Specification WSS-M97B51-A1.

A **50/50 mixture** of distilled water and Ford G05 Engine Coolant provides:

- **maximum cooling system efficiency.**
- **freeze protection down to -36° C (-34° F).**
- **boiling protection up to 129° C (265° F).**
- **protection against rust and other forms of corrosion.**
- **an accurate temperature readout from the engine coolant gauge.**

**The engine coolant must be maintained at the correct fluid level and concentration to work properly. If the engine coolant fluid level and concentration is not maintained correctly, damage to the engine and cooling system may result.**



## Maintenance and care

When the engine is cold, check the level of the engine coolant in the reservoir.

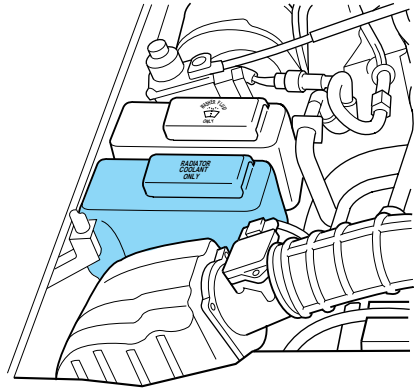

- The engine coolant should be at the “cold fill level” or within the “cold fill range” as listed on the engine coolant reservoir (depending upon application).
- Refer to the scheduled maintenance guide for service interval schedules.
- Be sure to read and understand *Precautions when servicing your vehicle* in this chapter.

If the engine coolant has not been checked at the recommended interval, the engine coolant reservoir may become low or empty. If the reservoir is low or empty, add engine coolant to the reservoir. Refer to *Adding engine coolant* in this chapter.



Automotive fluids are not interchangeable; do not use engine coolant, antifreeze or windshield washer fluid outside of its specified function and vehicle location.

### Adding engine coolant

**Use only Ford Premium Engine Coolant E2FZ-19549-AA (in Canada, Motorcraft CXC-10) or a premium engine coolant that meets Ford specification ESE-M97B44-A. Use only Ford G05 Engine Coolant WSS—M97B51-A1 (in Canada, Motorcraft CXC-10) or a premium engine coolant that meets Ford specification ESE-M97B44-A.**

## Maintenance and care

- **DO NOT USE Ford Extended Life Engine Coolant F6AZ-19544-AA (orange in color).**
- **DO NOT USE a DEX-COOL® engine coolant or an equivalent engine coolant that meets Ford specification WSS-M97B44-D.**
- **DO NOT USE alcohol or methanol antifreeze or any engine coolants mixed with alcohol or methanol antifreeze.**
- **DO NOT USE supplemental coolant additives in your vehicle. These additives may harm your engine's cooling system.**
- **DO NOT MIX recycled coolant and conventional coolant together in your vehicle. Mixing of engine coolants may harm your engine's cooling system.**
- **The use of an improper coolant may harm engine and cooling system components and may void the warranty of your vehicle's engine cooling system. If you are unsure which type of coolant your vehicle requires, contact your local dealer.**



Do not put engine coolant in the windshield washer fluid reservoir. If engine coolant is sprayed onto the windshield, it could make it difficult to see through the windshield.

When the engine is cool, add a **50/50 mixture** of engine coolant and distilled water to the engine coolant reservoir, until the coolant is at the “cold fill level” or within the “cold fill range” as listed in the engine coolant reservoir (depending upon application).

- **NEVER increase the coolant concentration above 60%.**
- **NEVER decrease the coolant concentration below 40%.**
- **Engine coolant concentrations above 60% or below 40% will decrease the freeze protection characteristics of the engine coolant and may cause engine damage.**

Plain water may be added in an emergency, but you **must** replace it with a 50/50 mixture of engine coolant and distilled water as soon as possible.

Check the coolant level in the reservoir before you drive your vehicle the next few times (with the engine cool). If necessary, add a **50/50 mixture** of engine coolant and distilled water to the engine coolant reservoir until the coolant level is at the “cold fill level” or within the “cold fill range” as listed on the reservoir (depending upon application).

## Maintenance and care

Have your dealer check the engine cooling system for leaks if you have to add more than 1.0 liter (1.0 quart) of engine coolant per month.



To avoid scalding hot steam or coolant from being released from the engine cooling system, never remove the reservoir cap while the engine is running or hot. Failure to follow this warning may result in damage to the engine's cooling system and possible severe personal injury.

If you must remove the coolant cap, follow these steps to avoid personal injury:

1. Before you remove the cap, turn the engine off and let it cool.
2. When the engine is cool, wrap a thick cloth around the cap. Slowly turn cap counterclockwise until pressure begins to release.
3. Step back while the pressure releases.
4. When you are sure that all the pressure has been released, use the cloth to turn it counterclockwise and remove the cap.

### Recycled engine coolant

Ford Motor Company recommends the use of a recycled engine coolant produced by Ford-approved processes.

Not all coolant recycling processes produce coolant which meets Ford specification WSS-M97B51-A1. Use of a recycled engine coolant which does not meet the Ford G05 specification may harm engine and cooling system components.



Always dispose of used automotive fluids in a responsible manner. Follow your community's regulations and standards for recycling and disposing of automotive fluids.

### Coolant refill capacity

To find out how much fluid your vehicle's cooling system can hold, refer to *Refill capacities* in the *Capacities and specifications* chapter.

Fill your engine coolant reservoir as outlined in *Adding engine coolant* in this chapter.

## Maintenance and care

### Severe climates

If you drive in extremely cold climates (less than  $-36^{\circ}\text{C}$  [ $-34^{\circ}\text{F}$ ]):

- **it may be necessary to increase the coolant concentration above 50%.**
- **NEVER increase the coolant concentration above 60%.**
- **increased engine coolant concentrations above 60% will decrease the overheat protection characteristics of the engine coolant and may cause engine damage.**
- **refer to the chart on the coolant container to ensure the coolant concentration in your vehicle will provide adequate freeze protection at the temperatures in which you drive in the winter months.**

If you drive in extremely hot climates:

- **it is still necessary to maintain the coolant concentration above 40%.**
- **NEVER decrease the coolant concentration below 40%.**
- **decreased engine coolant concentrations below 40% will decrease the corrosion protection characteristics of the engine coolant and may cause engine damage.**
- **decreased engine coolant concentrations below 40% will decrease the freeze protection characteristics of the engine coolant and may cause engine damage.**
- **refer to the chart on the coolant container to ensure the coolant concentration in your vehicle will provide adequate protection at the temperatures in which you drive.**

Vehicles driven year-round in non-extreme climates should use a 50/50 mixture of engine coolant and distilled water for optimum cooling system and engine protection.

### CHECKING AND ADDING POWER STEERING FLUID

Check the power steering fluid. Refer to the scheduled maintenance guide for the service interval schedules. If adding fluid is necessary, use only MERCON® ATF.

## Maintenance and care

- 4.0L V6 engine

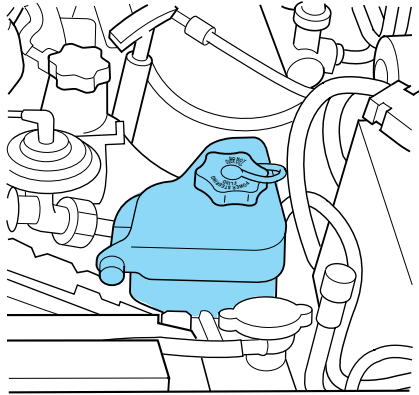

- 5.0L V8 engine

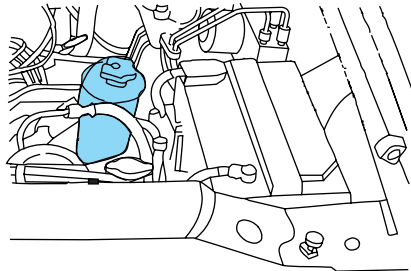

1. Start the engine and let it run until it reaches normal operating temperature (the engine coolant temperature gauge indicator will be near the center of the normal area between H and C).
2. While the engine idles, turn the steering wheel left and right several times.
3. Turn the engine off.
4. Check the fluid level in the reservoir.
5. The fluid level should be between the MIN and MAX lines. Do not add fluid if the level is in this range.
6. If the fluid is low, add fluid in small amounts, continuously checking the level until it reaches the correct operating range. Be sure to put the cap back on the reservoir.

# Maintenance and care

## TRANSMISSION FLUID

### Checking automatic transmission fluid (if equipped)

Refer to your scheduled maintenance guide for scheduled intervals for fluid checks and changes. Your transmission does not consume fluid. However, the fluid level should be checked if the transmission is not working properly, i.e., if the transmission slips or shifts slowly or if you notice some sign of fluid leakage.

Automatic transmission fluid expands when warmed. To obtain an accurate fluid check, drive the vehicle until it is at normal operating temperature (approximately 30 km [20 miles]). If your vehicle has been operated for an extended period at high speeds, in city traffic during hot weather or pulling a trailer, the vehicle should be turned off for about 30 minutes to allow fluid to cool before checking.

1. Drive the vehicle 30 km (20 miles) or until it reaches normal operating temperature.
2. Park the vehicle on a level surface and engage the parking brake.
3. With the parking brake engaged and your foot on the brake pedal, start the engine and move the gearshift lever through all of the gear ranges. Allow sufficient time for each gear to engage.
4. Latch the gearshift lever in P (Park) and leave the engine running.
5. Remove the dipstick, wiping it clean with a clean, dry lint free rag. If necessary, refer to *Identifying components in the engine compartment* in this chapter for the location of the dipstick.
6. Install the dipstick making sure it is fully seated in the filler tube.
7. Remove the dipstick and inspect the fluid level. The fluid should be in the designated area for normal operating temperature or ambient temperature.

### Low fluid level

Do not drive the vehicle if the fluid level is at the bottom of the dipstick and the ambient temperature is above 10°C (50°F).

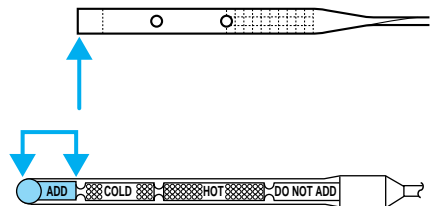

## Maintenance and care

### Correct fluid level

The transmission fluid should be checked at normal operating temperature  $66^{\circ}\text{C}$ - $77^{\circ}\text{C}$  ( $150^{\circ}\text{F}$ - $170^{\circ}\text{F}$ ) on a level surface. The normal operating temperature can be reached after approximately 30 km (20 miles) of driving.

You can check the fluid without driving if the ambient temperature is above  $10^{\circ}\text{C}$  ( $50^{\circ}\text{F}$ ). However, if fluid is added at this time, an overfill condition could result when the vehicle reaches normal operating temperature.

The transmission fluid should be in this range if at normal operating temperature ( $66^{\circ}\text{C}$ - $77^{\circ}\text{C}$  [ $150^{\circ}\text{F}$ - $170^{\circ}\text{F}$ ]).

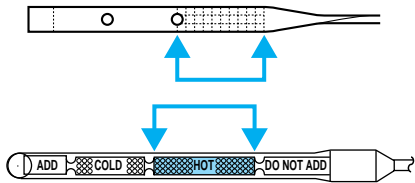

The transmission fluid should be in this range if at ambient temperature ( $10^{\circ}\text{C}$ - $35^{\circ}\text{C}$  [ $50^{\circ}\text{F}$ - $95^{\circ}\text{F}$ ]).

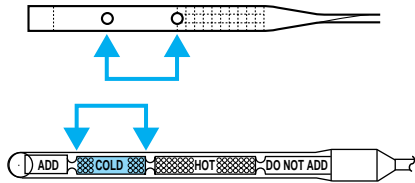

### High fluid level

Fluid levels above the safe range may result in transmission failure. An overfill condition of transmission fluid may cause shift and/or engagement concerns and/or possible damage.

High fluid levels can be caused by an overheating condition.

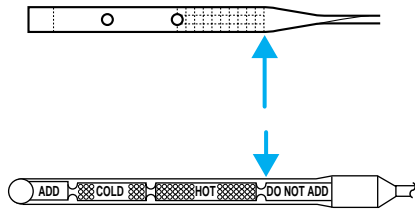

### Adjusting automatic transmission fluid levels

Before adding any fluid, make sure the correct type is used. The type of fluid used is normally indicated on the dipstick and also in the *Lubricant specifications* section in the *Capacities and specifications* chapter.

## Maintenance and care

**Use of a non-approved automatic transmission fluid may cause internal transmission component damage.**

If necessary, add fluid in 250 mL (1/2 pint) increments through the filler tube until the level is correct.

If an overfill occurs, excess fluid should be removed by a qualified technician.

**An overfill condition of transmission fluid may cause shift and/or engagement concerns and/or possible damage.**

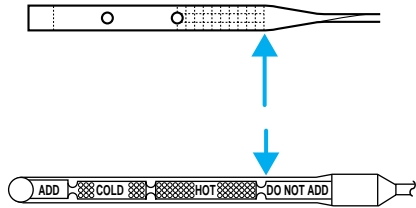

### CHECKING AND ADDING TRANSFER CASE FLUID (IF EQUIPPED)

1. Clean the filler plug.
2. Remove the filler plug and inspect the fluid level.

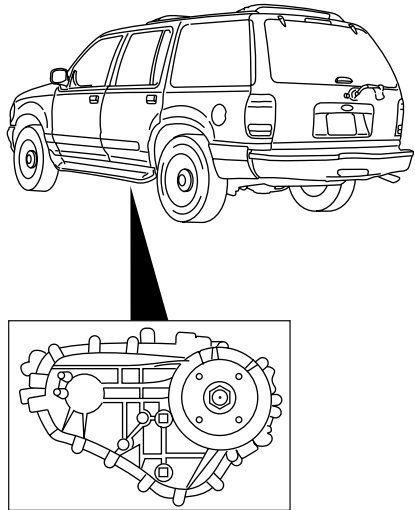



## Maintenance and care

3. Add only enough fluid through the filler opening so that the fluid level is at the bottom of the opening.

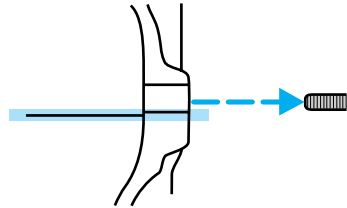

Use only fluid that meets Ford specifications. Refer to the *Capacities and specifications* chapter.

### DRIVELINE UNIVERSAL JOINT AND SLIP YOKE

Your vehicle may be equipped with universal joints that require lubrication. Refer to the scheduled maintenance guide for maintenance intervals. If the original universal joints are replaced with universal joints equipped with grease fittings, lubrication will also be necessary.

### BATTERY

Your vehicle is equipped with a Motorcraft maintenance-free battery which normally does not require additional water during its life of service.

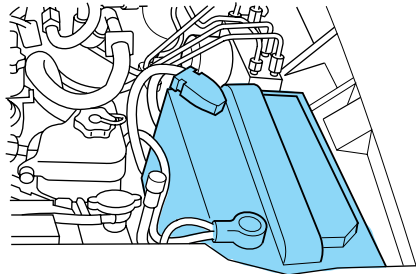

However, for severe usage or in high temperature climates, check the battery electrolyte level. Refer to the scheduled maintenance guide for the service interval schedules.

**Keep the electrolyte level in each cell up to the “level indicator”. Do not overfill the battery cells.**

If the electrolyte level in the battery is low, you can add plain tap water to the battery, as long as you do not use hard water (water with a high mineral or alkali content). If possible, however, try to only fill the battery

## Maintenance and care

cells with distilled water. If the battery needs water often, have the charging system checked.

**If your battery has a cover/shield, make sure it is reinstalled after the battery has been cleaned or replaced.**

For longer, trouble-free operation, keep the top of the battery clean and dry. Also, make certain the battery cables are always tightly fastened to the battery terminals.

If you see any corrosion on the battery or terminals, remove the cables from the terminals and clean with a wire brush. You can neutralize the acid with a solution of baking soda and water.

When the battery is disconnected or a new battery installed, the transmission must learn its adaptive strategy. As a result of this, the transmission may shift firmly. This operation is considered normal and will fully update transmission operation to its optimum shift feel.



Batteries normally produce explosive gases which can cause personal injury. Therefore, do not allow flames, sparks or lighted substances to come near the battery. When working near the battery, always shield your face and protect your eyes. Always provide proper ventilation.



When lifting a plastic-cased battery, excessive pressure on the end walls could cause acid to flow through the vent caps, resulting in personal injury and/or damage to the vehicle or battery. Lift the battery with a battery carrier or with your hands on opposite corners.



Keep batteries out of reach of children. Batteries contain sulfuric acid. Avoid contact with skin, eyes or clothing. Shield your eyes when working near the battery to protect against possible splashing of acid solution. In case of acid contact with skin or eyes, flush immediately with water for a minimum of 15 minutes and get prompt medical attention. If acid is swallowed, call a physician immediately.



Battery posts, terminals and related accessories contain lead and lead compounds. **Wash hands after handling.**

## Maintenance and care

Because your vehicle's engine is electronically controlled by a computer, some control conditions are maintained by power from the battery. When the battery is disconnected or a new battery is installed, the engine must relearn its idle and fuel trim strategy for optimum driveability and performance. To begin this process:

1. With the vehicle at a complete stop, set the parking brake.
  2. Put the gearshift in P (Park), turn off all accessories and start the engine.
  3. Run the engine until it reaches normal operating temperature.
  4. Allow the engine to idle for at least one minute.
  5. Turn the A/C on and allow the engine to idle for at least one minute.
  6. Drive the vehicle to complete the relearning process.
- The vehicle may need to be driven to relearn the idle and fuel trim strategy.
  - **If you do not allow the engine to relearn its idle trim, the idle quality of your vehicle may be adversely affected until the idle trim is eventually relearned.**

When the battery is disconnected or a new battery installed, the transmission must relearn its adaptive strategy. As a result of this, the transmission may shift firmly. This operation is considered normal and will not affect function or durability of the transmission. Over time the adaptive learning process will fully update transmission operation to its optimum shift feel.

If the battery has been disconnected or a new battery has been installed, the clock and the preset radio stations must be reset once the battery is reconnected.

- Always dispose of automotive batteries in a responsible manner. Follow your local authorized standards for disposal. Call your local authorized recycling center to find out more about recycling automotive batteries.

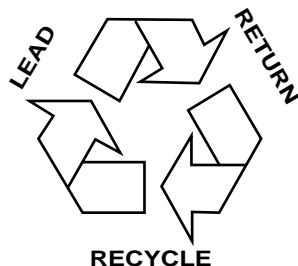

## Maintenance and care

### WINDSHIELD WIPER BLADES

Check the wiper blades at least twice a year or when they seem less effective. Substances such as tree sap and some hot wax treatments used by commercial car washes reduce the effectiveness of wiper blades.

#### Checking the wiper blades

If the wiper blades do not wipe properly, clean both the windshield and wiper blades using undiluted windshield wiper solution or a mild detergent. Rinse thoroughly with clean water. To avoid damaging the blades, do not use fuel, kerosene, paint thinner or other solvents.

#### Changing the wiper blades

To replace the wiper blades:

1. Pull the wiper arm away from the windshield and lock into the service position.
2. Turn the blade at an angle from the wiper arm. Push the lock pin manually to release the blade and pull the wiper blade down toward the windshield to remove it from the arm.
3. Attach the new wiper to the wiper arm and press it into place until a click is heard.

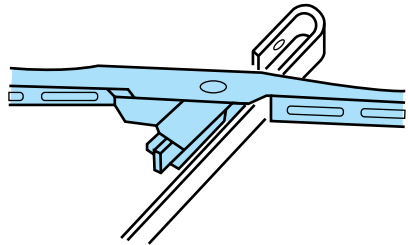

### REAR WINDOW WIPER BLADES

Refer to *Windshield Wiper Blades* in this section for more information on rear wiper blades.

#### INFORMATION ABOUT UNIFORM TIRE QUALITY GRADING

New vehicles are fitted with tires that have a rating on them called Tire Quality Grades. The Quality grades can be found where applicable on the tire sidewall between tread shoulder and maximum section width. For example:

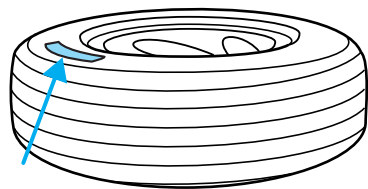

- **Treadwear 200 Traction AA Temperature A**

## Maintenance and care

These Tire Quality Grades are determined by standards that the United States Department of Transportation has set.

Tire Quality Grades apply to new pneumatic tires for use on passenger cars. They do not apply to deep tread, winter-type snow tires, space-saver or temporary use spare tires, tires with nominal rim diameters of 10 to 12 inches or limited production tires as defined in Title 49 Code of Federal Regulations Part 575.104(c)(2).

**U.S. Department of Transportation-Tire quality grades:** The U.S. Department of Transportation requires Ford to give you the following information about tire grades exactly as the government has written it.

### Treadwear

The treadwear grade is a comparative rating based on the wear rate of the tire when tested under controlled conditions on a specified government test course. For example, a tire graded 150 would wear one and one-half (1 1/2) times as well on the government course as a tire graded 100. The relative performance of tires depends upon the actual conditions of their use, however, and may depart significantly from the norm due to variations in driving habits, service practices, and differences in road characteristics and climate.

### Traction AA A B C

The traction grades, from highest to lowest are AA, A, B, and C. Those grades represent the tire's ability to stop on wet pavement as measured under controlled conditions on specified government test surfaces of asphalt and concrete. A tire marked C may have poor traction performance.



The traction grade assigned to this tire is based on straight-ahead braking traction tests, and does not include acceleration, cornering, hydroplaning or peak traction characteristics.

## Maintenance and care

### Temperature A B C

The temperature grades are A (the highest), B, and C, representing the tire's resistance to the generation of heat and its ability to dissipate heat when tested under controlled conditions on a specified indoor laboratory test wheel. Sustained high temperature can cause the material of the tire to degenerate and reduce tire life, and excessive temperature can lead to sudden tire failure. The grade C corresponds to a level of performance which all passenger car tires must meet under the Federal Motor Vehicle Safety Standard No. 109. Grades B and A represent higher levels of performance on the laboratory test wheel than the minimum required by law.



The temperature grade for this tire is established for a tire that is properly inflated and not overloaded. Excessive speed, underinflation, or excessive loading, either separately or in combination, can cause heat buildup and possible tire failure.

## SERVICING YOUR TIRES

### Checking the tire pressure

- Use an accurate tire pressure gauge.
- Check the tire pressure when tires are cold, after the vehicle has been parked for at least one hour or has been driven less than 5 km (3 miles).
- Adjust tire pressure to recommended specifications found on the Certification Label or the Tire Label.



Improperly inflated tires can affect vehicle handling and can fail suddenly, possibly resulting in loss of vehicle control.

### Tire rotation

Because your vehicle's tires perform different jobs, they often wear differently. To make sure your tires wear evenly and last longer, rotate them as indicated in the scheduled maintenance guide. If you notice that the tires wear unevenly, have them checked.

The following procedure applies to vehicles equipped with single rear wheels.

## Maintenance and care

- 15" Four tire rotation

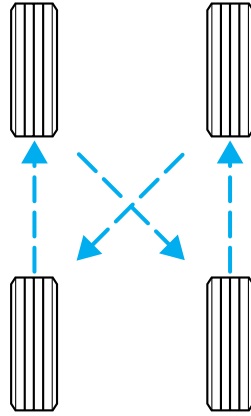

- 16" Five tire rotation

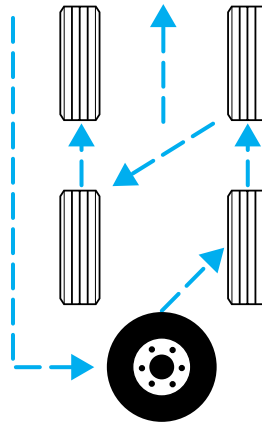

## Maintenance and care

### Replacing the tires

Replace the tires when the wear band is visible through the tire treads.

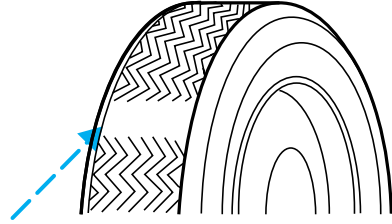

When replacing full size tires, never mix radial bias-belted, or bias-type tires. Use only the tire sizes that are listed on the Certification Label. Make sure that all tires are the same size, speed rating, and load-carrying capacity. Use only the tire combinations recommended on the label. If you do not follow these precautions, your vehicle may not drive properly and safely.



Make sure that all replacement tires are of the same size, type, load-carrying capacity and tread design (e.g., “All Terrain”, etc.), as originally offered by Ford.



Do not replace your tires with “high performance” tires or larger size tires.



Failure to follow these precautions may adversely affect the handling of the vehicle and make it easier for the driver to lose control and roll over.

Tires that are larger or smaller than your vehicle’s original tires may also affect the accuracy of your speedometer.



## Maintenance and care

### USING SNOW TIRES AND TRACTION DEVICES



Snow tires must be the same size and grade as the tires you currently have on your vehicle.

The tires on your vehicle have all-weather treads to provide traction in rain and snow. However, in some climates, using snow tires and traction devices may be necessary. Ford offers tire cables as a Ford approved accessory and recommends use of these or their equivalents. See your dealer or qualified service technician for more information on tire cables for your vehicle.

Follow these guidelines when using snow tires and traction devices:

- Install cables securely, verifying that the cables do not touch any wiring, brake lines or fuel lines.
- Drive cautiously. If you hear the cables rub or bang against the vehicle, stop and retighten them. If this does not work, remove the cables to prevent vehicle damage.
- Avoid overloading your vehicle.
- Remove the tire cables when they are no longer needed.
- Do not use cables on dry roads.
- The suspension insulation and bumpers will help prevent vehicle damage. Do not remove these components from the vehicle when using snow tires and traction devices.
- Do not exceed 48 km/h (30 mph) with tire cables on your vehicle.

Consult your dealer for information on other Ford approved methods of traction control.

## Maintenance and care

### WHAT YOU SHOULD KNOW ABOUT AUTOMOTIVE FUELS

#### Important safety precautions



Do not overfill the fuel tank. The pressure in an overfilled tank may cause leakage and lead to fuel spray and fire.



The fuel system may be under pressure. If the fuel filler cap is venting vapor or if you hear a hissing sound, wait until it stops before completely removing the fuel filler cap. Otherwise, fuel may spray out and injure you or others.



If you do not use the proper fuel filler cap, excessive pressure or vacuum in the fuel tank may damage the fuel system or cause the fuel cap to disengage in a collision, which may result in possible personal injury.



Automotive fuels can cause serious injury or death if misused or mishandled.



Gasoline may contain benzene, which is a cancer-causing agent.

Observe the following guidelines when handling automotive fuel:

- Extinguish all smoking materials and any open flames before fueling your vehicle.
- Always turn off the vehicle before fueling.
- Automotive fuels can be harmful or fatal if swallowed. Fuel such as gasoline is highly toxic and if swallowed can cause death or permanent injury. If fuel is swallowed, call a physician immediately, even if no symptoms are immediately apparent. The toxic effects of fuel may not be visible for hours.

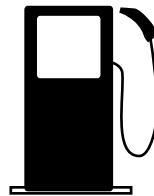

## Maintenance and care

- Avoid inhaling fuel vapors. Inhaling too much fuel vapor of any kind can lead to eye and respiratory tract irritation. In severe cases, excessive or prolonged breathing of fuel vapor can cause serious illness and permanent injury.
- Avoid getting fuel liquid in your eyes. If fuel is splashed in the eyes, remove contact lenses (if worn), flush with water for 15 minutes and seek medical attention. Failure to seek proper medical attention could lead to permanent injury.
- Fuels can also be harmful if absorbed through the skin. If fuel is splashed on the skin and/or clothing, promptly remove contaminated clothing and wash skin thoroughly with soap and water. Repeated or prolonged skin contact with fuel liquid or vapor causes skin irritation.
- Be particularly careful if you are taking “Antabuse” or other forms of disulfiram for the treatment of alcoholism. Breathing gasoline vapors, or skin contact could cause an adverse reaction. In sensitive individuals, serious personal injury or sickness may result. If fuel is splashed on the skin, promptly wash skin thoroughly with soap and water. Consult a physician immediately if you experience an adverse reaction.



When refueling always shut the engine off and never allow sparks or open flames near the filler neck. Never smoke while refueling. Fuel vapor is extremely hazardous under certain conditions. Care should be taken to avoid inhaling excess fumes.



The flow of fuel through a fuel pump nozzle can produce static electricity, which can cause a fire if fuel is pumped into an ungrounded fuel container.

Use the following guidelines to avoid static build-up when filling an ungrounded fuel container:

- Place approved fuel container on the ground.
- DO NOT fill a fuel container while it is in the vehicle.
- Keep the fuel pump nozzle in contact with the fuel container while filling.
- DO NOT use a device that would hold the fuel pump handle in the fill position.

## Maintenance and care

### Choosing the right fuel

Use only UNLEADED FUEL. The use of leaded fuel is prohibited by law and could damage your vehicle.

Do not use fuel containing methanol. It can damage critical fuel system components.

Your vehicle was not designed to use fuel or fuel additives with metallic compounds, including manganese-based compounds containing MMT.

Repairs to correct the effects of using a fuel for which your vehicle was not designed may not be covered by your warranty.

### Octane recommendations

Your vehicle is designed to use “Regular” unleaded gasoline with pump (R+M)/2 octane rating of 87. We do not recommend the use of gasolines labeled as “Regular” that are sold with octane ratings of 86 or lower in high altitude areas.

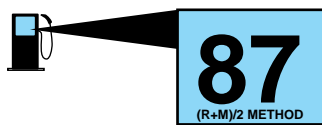

Do not be concerned if your engine sometimes knocks lightly. However, if it knocks heavily under most driving conditions while you are using fuel with the recommended octane rating, see your dealer or a qualified service technician to prevent any engine damage.

### Fuel quality

If you are experiencing starting, rough idle or hesitation driveability problems during a cold start, try a different brand of “Regular” unleaded gasoline. “Premium” unleaded gasoline is not recommended (particularly in the United States) because it may cause these problems to become more pronounced. If the problems persist, see your dealer or a qualified service technician.

It should not be necessary to add any aftermarket products to your fuel tank if you continue to use high quality fuel of the recommended octane rating. Aftermarket products could cause damage to the fuel system. Repairs to correct the effects of using an aftermarket product in your fuel may not be covered by your warranty.

## Maintenance and care

Many of the world's automakers issued the World-wide Fuel Charter that recommends gasoline specifications to provide improved performance and emission control system protection for your vehicle. Gasolines that meet the World-wide Fuel Charter should be used when available. Ask your fuel supplier about gasolines that meet the World-wide Fuel Charter. In Canada, look for fuels that display the **Auto Makers' Choice**<sup>™</sup> logo.



### Cleaner air

Ford endorses the use of reformulated “cleaner-burning” gasolines to improve air quality.

### Running out of fuel

Avoid running out of fuel because this situation may have an adverse affect on powertrain components.

If you have run out of fuel:

- You may need to cycle the ignition from OFF to ON several times after refueling, to allow the fuel system to pump the fuel from the tank to the engine.
- Your “Check Engine” indicator may come on. For more information on the “Check Engine” indicator, refer to the *Instrumentation* chapter.

### Fuel Filler Cap

Your fuel tank filler cap has an indexed design with a 1/8 turn on/off feature.

When fueling your vehicle:

1. Turn the engine off.
2. Carefully turn the filler cap counterclockwise 1/8 of a turn until it stops.
3. Pull to remove the cap from the fuel filler pipe.
4. To install the cap, align the tabs on the cap with the notches on the filler pipe.
5. Turn the filler cap clockwise 1/8 of a turn until it stops.

## Maintenance and care

If the “Service Engine Soon/Check Engine” indicator comes on and stays on after you start the engine, the fuel filler cap may not be properly installed. Turn off the engine, remove the fuel filler cap, align the cap properly and reinstall it.

**If you must replace the fuel filler cap, replace it with a fuel filler cap that is designed for your vehicle. The customer warranty may be void for any damage to the fuel tank or fuel system if the correct genuine Ford or Motorcraft fuel filler cap is not used.**



The fuel system may be under pressure. If the fuel filler cap is venting vapor or if you hear a hissing sound, wait until it stops before completely removing the fuel filler cap. Otherwise, fuel may spray out and injure you or others.



If you do not use the proper fuel filler cap, excessive pressure or vacuum in the fuel tank may damage the fuel system or cause the fuel cap to disengage in a collision, which may result in possible personal injury.

### Fuel Filter

For fuel filter replacement, see your dealer or a qualified service technician. Refer to the scheduled maintenance guide for the appropriate intervals for changing the fuel filter.

**Replace the fuel filter with an authorized Motorcraft part. The customer warranty may be void for any damage to the fuel system if an authorized Motorcraft fuel filter is not used.**

## ESSENTIALS OF GOOD FUEL ECONOMY

### Measuring techniques

Your best source of information about actual fuel economy is you, the driver. You must gather information as accurately and consistently as possible. Fuel expense, frequency of fillups or fuel gauge readings are NOT accurate as a measure of fuel economy. We do not recommend taking fuel economy measurements during the first 1 600 km (1 000 miles) of driving (engine break-in period). You will get a more accurate measurement after 3 000 km–5 000 km (2 000 miles–3 000 miles).

## Maintenance and care

### Filling the tank

The advertised fuel capacity of the fuel tank on your vehicle is equal to the rated refill capacity of the fuel tank as listed in the *Refill Capacities* section of the *Capacities and specifications* chapter.

The advertised capacity is the amount of the indicated capacity and the empty reserve combined. Indicated capacity is the difference in the amount of fuel in a full tank and a tank when the fuel gauge indicates empty. Empty reserve is the small amount of fuel remaining in the fuel tank after the fuel gauge indicates empty.

**The amount of usable fuel in the empty reserve varies and should not be relied upon to increase driving range. When refueling your vehicle after the fuel gauge indicates empty, you might not be able to refuel the full amount of the advertised capacity of the fuel tank due to the empty reserve still present in the tank.**

For consistent results when filling the fuel tank:

- Turn the engine/ignition switch to the off position prior to refueling, an error in the reading will result if the engine is left running.
- Use the same filling rate setting (low — medium — high) each time the tank is filled.
- Allow no more than 2 automatic click-offs when filling.
- Always use fuel with the recommended octane rating.
- Use a known quality gasoline, preferably a national brand.
- Use the same side of the same pump and have the vehicle facing the same direction each time you fill up.
- Have the vehicle loading and distribution the same every time.

Your results will be most accurate if your filling method is consistent.

### Calculating fuel economy

1. Fill the fuel tank completely and record the initial odometer reading (in kilometers or miles).
2. Each time you fill the tank, record the amount of fuel added (in liters or gallons).
3. After at least three to five tank fill-ups, fill the fuel tank and record the current odometer reading.
4. Subtract your initial odometer reading from the current odometer reading.

## Maintenance and care

5. Follow one of the simple calculations in order to determine fuel economy:

**Multiply liters used by 100, then divide by total kilometers traveled.**

**Divide total miles traveled by total gallons used.**

Keep a record for at least one month and record the type of driving (city or highway). This will provide an accurate estimate of the vehicle's fuel economy under current driving conditions. Additionally, keeping records during summer and winter will show how temperature impacts fuel economy. In general, lower temperatures give lower fuel economy.

### **Driving style — good driving and fuel economy habits**

Give consideration to the lists that follow and you may be able to change a number of variables and improve your fuel economy.

#### ***Habits***

- Smooth, moderate operation can yield up to 10% savings in fuel.
- Steady speeds without stopping will usually give the best fuel economy.
- Idling for long periods of time (greater than one minute) may waste fuel.
- Anticipate stopping; slowing down may eliminate the need to stop.
- Sudden or hard accelerations may reduce fuel economy.
- Slow down gradually.
- Driving at reasonable speeds (traveling at 88 km/h [55 mph] uses 15% less fuel than traveling at 105 km/h [65 mph]).
- Revving the engine before turning it off may reduce fuel economy.
- Using the air conditioner or defroster may reduce fuel economy.
- You may want to turn off the speed control in hilly terrain if unnecessary shifting between third and fourth gear occurs. Unnecessary shifting of this type could result in reduced fuel economy.
- Warming up a vehicle on cold mornings is not required and may reduce fuel economy.
- Resting your foot on the brake pedal while driving may reduce fuel economy.
- Combine errands and minimize stop-and-go driving.



## Maintenance and care

### **Maintenance**

- Keep tires properly inflated and use only recommended size.
- Operating a vehicle with the wheels out of alignment will reduce fuel economy.
- Use recommended engine oil. Refer to *Lubricant Specifications*.
- Perform all regularly scheduled maintenance items. Follow the recommended maintenance schedule and owner maintenance checks found in your vehicle scheduled maintenance guide.

### **Conditions**

- Heavily loading a vehicle or towing a trailer may reduce fuel economy at any speed.
- Carrying unnecessary weight may reduce fuel economy (approximately 0.4 km/L [1 mpg] is lost for every 180 kg [400 lb] of weight carried).
- Adding certain accessories to your vehicle (for example bug deflectors, rollbars/light bars, running boards, ski/luggage racks) may reduce fuel economy.
- Using fuel blended with alcohol may lower fuel economy.
- Fuel economy may decrease with lower temperatures during the first 12–16 km (8–10 miles) of driving.
- Driving on flat terrain offers improved fuel economy as compared to driving on hilly terrain.
- Transmissions give their best fuel economy when operated in the top cruise gear and with steady pressure on the gas pedal.
- Four-wheel-drive operation (if equipped) is less fuel efficient than two-wheel-drive operation.
- Close windows for high speed driving.

### **EPA window sticker**

Every new vehicle should have the EPA window sticker. Contact your dealer if the window sticker is not supplied with your vehicle. The EPA window sticker should be your guide for the fuel economy comparisons with other vehicles.

It is important to note the box in the lower left corner of the window sticker. These numbers represent the Range of L/100 km (MPG) expected on the vehicle under optimum conditions. Your fuel economy may vary depending upon the method of operation and conditions.

## Maintenance and care

### EMISSION CONTROL SYSTEM

Your vehicle is equipped with various emission control components and a catalytic converter which will enable your vehicle to comply with applicable exhaust emission standards. To make sure that the catalytic converter and other emission control components continue to work properly:

- Use only the specified fuel listed.
- Avoid running out of fuel.
- Do not turn off the ignition while your vehicle is moving, especially at high speeds.
- Have the items listed in your scheduled maintenance guide performed according to the specified schedule.

The scheduled maintenance items listed in the scheduled maintenance guide are essential to the life and performance of your vehicle and to its emissions system.

If other than Ford, Motorcraft or Ford-authorized parts are used for maintenance replacements or for service of components affecting emission control, such non-Ford parts should be equivalent to genuine Ford Motor Company parts in performance and durability.



Do not park, idle, or drive your vehicle in dry grass or other dry ground cover. The emission system heats up the engine compartment and exhaust system, which can start a fire.

Illumination of the “Check Engine” light, charging system warning light or the temperature warning light, fluid leaks, strange odors, smoke or loss of engine power, could indicate that the emission control system is not working properly.



Exhaust leaks may result in entry of harmful and potentially lethal fumes into the passenger compartment.

Do not make any unauthorized changes to your vehicle or engine. By law, vehicle owners and anyone who manufactures, repairs, services, sells, leases, trades vehicles, or supervises a fleet of vehicles are not permitted to intentionally remove an emission control device or prevent it from working. Information about your vehicle’s emission system is on the Vehicle Emission Control Information Decal located on or near the engine. This decal identifies engine displacement and gives some tune up specifications.

## Maintenance and care

Please consult your “Warranty Guide” for complete emission warranty information.

### Readiness for Inspection/Maintenance (I/M) testing

In some localities, it may be a legal requirement to pass an I/M test of the on-board diagnostics system. If your “Check Engine/Service Engine Soon” light is on, refer to the description in the *Warning Lights and Chimes* section of the *Instrumentation* chapter. Your vehicle may not pass the I/M test with the “Check Engine/Service Engine Soon” light on.

If the vehicle’s powertrain system or its battery has just been serviced, the on-board diagnostics system is reset to a “not ready for I/M test” condition. To ready the on-board diagnostics system for I/M testing, a minimum of 30 minutes of city and highway driving is necessary as described below:

- First, at least 10 minutes of driving on an expressway or highway.
- Next, at least 20 minutes driving in stop-and-go, city-type traffic with at least four idle periods.

Allow the vehicle to sit for at least eight hours without starting the engine. Then, start the engine and complete the above driving cycle. The engine must warm up to its normal operating temperature. Once started, do not turn off the engine until the above driving cycle is complete.

## BULBS

### Replacing exterior bulbs

Check the operation of the following lamps frequently:

- Headlamps
- Foglamps
- High-mount brakelamp
- Brakelamps
- Turn signals
- License plate lamp
- Tail lamps
- Back-up lamps

Do not remove lamp bulbs unless they can be replaced immediately with new ones. If a bulb is removed for an extended period of time, contaminants may enter the lamp housings and affect lamp performance.

## Maintenance and care

### Replacing headlamp bulbs

To remove the headlamp bulb:

1. Make sure headlamp switch is in OFF position, then lift hood and open the hinged headlamp cover.

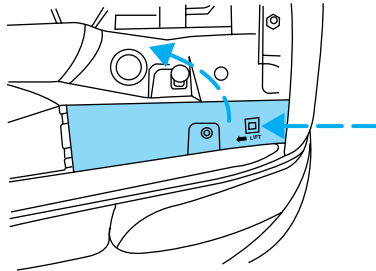

2. Disconnect the electrical connector from the bulb by pulling rearward.

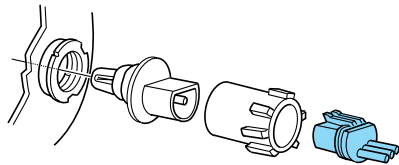

3. Remove the bulb retaining ring by rotating it counterclockwise (when viewed from the rear) to free it from the bulb socket, and slide the ring off the plastic base. Keep the ring to retain the new bulb.

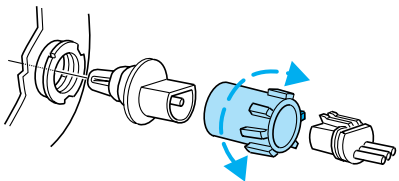

4. Remove the old bulb from the lamp assembly by gently pulling it straight back out of the lamp assembly.

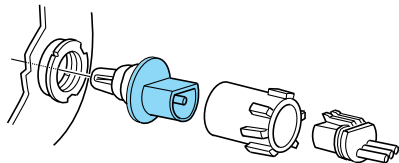

To install the new bulb:



Handle a halogen headlamp bulb carefully and keep out of children's reach. Grasp the bulb only by its plastic base and do not touch the glass. The oil from your hand could cause the bulb to break the next time the headlamps are operated.

## Maintenance and care

*If the bulb is accidentally touched, it should be cleaned with rubbing alcohol before being used.*

1. With the flat side of the new bulb's plastic base facing upward, insert the glass end of the bulb into the lamp assembly. You may need to turn the bulb left or right to align the grooves in the plastic base with the tabs in the lamp assembly. When the grooves are aligned, push the bulb into the lamp assembly until the plastic base contacts the rear of the lamp assembly.
2. Install the bulb retaining ring over the plastic base until it contacts the rear of the socket by rotating clockwise until you feel a "stop."
3. Install the electrical connector into the rear of the plastic base until it snaps, locking it into position.
4. Turn the headlamps on and make sure they work properly. If the headlamp was correctly aligned before you changed the bulb, you should not need to align it again.

### **Replacing front parking lamp/turn signal/sidemarkers bulbs**

5. Remove two screws from the lamp assembly.
6. Disengage lamp assembly.

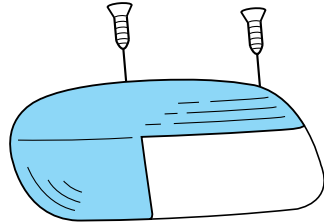

7. Rotate bulb socket counterclockwise and remove from lamp assembly.
8. Carefully pull bulb straight out of socket and push in the new bulb.
9. Install bulb socket in lamp assembly by turning clockwise.
10. Align the parking lamp studs with the plastic grommets on the vehicle and push to snap in place.
11. Install two screws on lamp assembly.

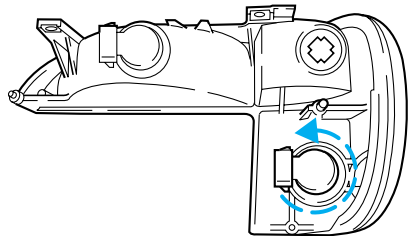

## Maintenance and care

### **Replacing tail lamp/turn/backup lamp bulbs**

The tail lamp/turn/backup lamp bulbs are located in the tail lamp assembly, one just below the other. Follow the same steps to replace either bulb:

1. Open the liftgate to expose the lamp assemblies.
2. Remove the two screws from the lamp assembly.
3. Carefully remove the lamp assembly by pulling it rearward.
4. Rotate the bulb socket counterclockwise and remove from lamp assembly.
5. Pull the bulb straight out of the socket and push in the new bulb.
6. To complete installation, follow the removal procedure in reverse order.

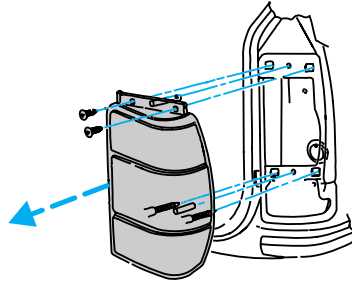

### **Replacing foglamp bulbs**

1. Remove the bulb socket from the foglamp by turning counterclockwise.
2. Disconnect the electrical connector from the foglamp bulb.
3. Connect the electrical connector to the new foglamp bulb.
4. Install the bulb socket in the foglamp turning clockwise.

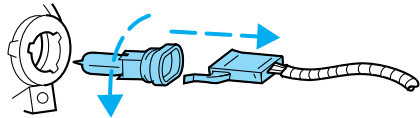

### **Replacing license plate lamp bulbs**

1. Remove two screws and the license plate lamp assembly from the liftgate.
2. Remove bulb socket from lamp assembly by turning counterclockwise.
3. Pull the bulb out from socket and push in the new bulb.

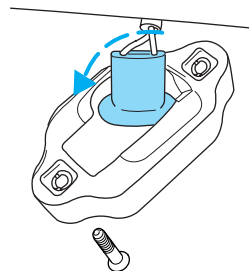

## Maintenance and care

4. Install the bulb socket in lamp assembly turning it clockwise,
5. Install the lamp assembly on liftgate with two screws.

### **Replacing high-mount brake lamp bulbs**

1. Remove the two screws and move the lamp assembly away from the liftgate.

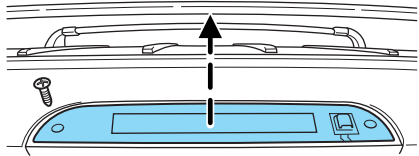

2. Disconnect the washer hose.
3. Remove the bulb holder from the lamp assembly by depressing the snaps.

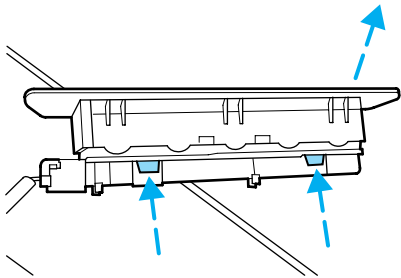

4. Pull the bulb straight out of the socket and push in the new bulb.
- To complete installation, follow the removal procedure in reverse order.

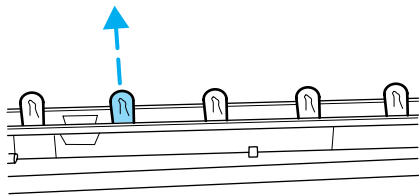

## Maintenance and care

### USING THE RIGHT BULBS

Replacement bulbs are specified in the chart below. Headlamp bulbs must be marked with an authorized “D.O.T.” for North America and an “E” for Europe to assure lamp performance, light brightness and pattern and safe visibility. The correct bulbs will not damage the lamp assembly or void the lamp assembly warranty and will provide quality bulb burn time.

<b>Function</b>	<b>Number of bulbs</b>	<b>Trade number</b>
Park/turn lamps (front)	2	3157 AK (amber)
Headlamps	2	9007
Rear stop/tail lamps	2	3157K
Rear turn lamps	2	3156K
Rear license plate lamps	2	3156K/168
Backup lamp	2	3156K
Rear/turn/sidemarker	2	916 AK (amber)
Fog lamp	2	899
Cargo lamp	1	211-2
Interior overhead lamp	1	912 (906)
Front door courtesy lamp	1	168
Map lamps	2	168 (T10)
Ashtray lamp	1	161
All replacement bulbs are clear in color except where noted.		
To replace all instrument panel lights - see your dealer.		

### AIMING THE HEADLAMPS

The headlamps on your vehicle are properly aimed at the assembly plant. If your vehicle has been in an accident the alignment of your headlamps should be checked by a qualified service technician.

### CLEANING AND CARING FOR YOUR VEHICLE

Refer to the Customer Assistance chapter for a list of Ford-approved cleaners, polishes and waxes.



## Maintenance and care

### Washing your vehicle

Wash your vehicle regularly with cold or lukewarm water. Never use strong detergents or soap. If your vehicle is particularly dirty, use a quality car wash detergent. Always use a clean sponge, washing glove or similar device and plenty of water for best results. To avoid spots, avoid washing when the hood is still warm, immediately after or during exposure to strong sunlight.

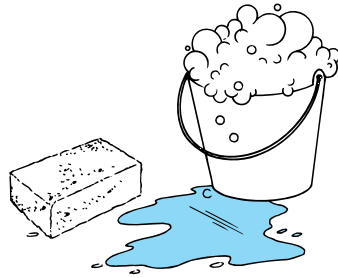

During winter months, it is especially important to wash the vehicle on a regular basis. Large quantities of dirt and road salt are difficult to remove and also cause damage to the vehicle.

Any gasoline spilled on the vehicle or deposits such as bird droppings should be washed and sponged off as soon as possible. Deposits not removed promptly can cause damage to the vehicle's paintwork.

Remove any exterior accessories, such as antennas, before entering a car wash. If you have wax applied to the vehicle at a commercial car wash, it is recommended that you clean the wiper blades and windshield as described in *Cleaning the wiper blades and windshield*.

After washing, apply the brakes several times to dry them.

### Waxing your vehicle

Waxing your vehicle on a regular basis will reduce minor scratches and paint damage.

Wax when water stops beading on the surface. This could be every three or four months, depending on operating conditions.

Use only carnauba or synthetic-based waxes. Use a cleaning fluid with a clean cloth to remove any bugs before waxing your vehicle. Use tar remover to remove any tar spots.

Avoid getting wax on the windshield, or on any surfaces which appear coarse or bumpy. If you have wax applied at a commercial car wash, it is recommended that you clean the wiper blades and windshield as described in *Cleaning the wiper blades and windshield*.

## Maintenance and care

### Repairing paint chips

Minor scratches or paint damage from road debris may be repaired with the Ultra Touch Prep and Finishing Kit (#F7AZ-19K507-BA), Lacquer Touch-up Paint (#ALBZ-19500-XXXXA), or Exterior Acrylic Spray Lacquer (#ALAZ-19500-XXXXA) from the Ford Car Care Chemicals line. Please note that the part numbers (shown as XXXX above) will vary with your vehicle's specific coloring. Observe the application instructions on the products.

Remove particles such as bird droppings, tree sap, insect remains, tar spots, road salt and industrial fallout immediately.

### Cleaning the engine

Engines are more efficient when they are clean because grease and dirt buildup keep the engine warmer than normal. When washing:

- Take care when using a power washer to clean the engine. The high pressure fluid could penetrate the sealed parts and cause damage.
- Do not spray with cold water to avoid cracking the engine block or other engine components.
- Cover the highlighted areas to prevent water damage when cleaning the engine.

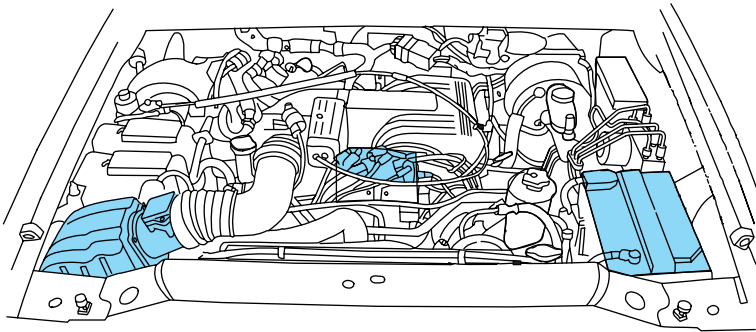

- 5.0L

## Maintenance and care

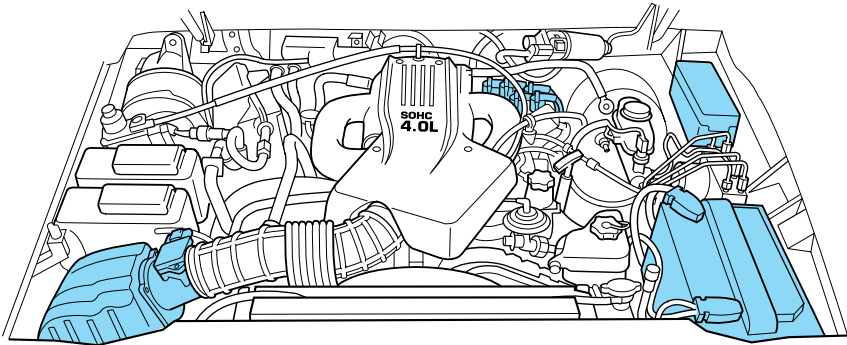

- 4.0L SOHC
- Never wash or rinse the engine while it is running; water in the running engine may cause internal damage.

### Cleaning the wheels

Wash with the same detergent as the body of your vehicle. Do not use acid-based or alcohol-based wheel cleaners, steel wool, fuel or strong detergents. Never use abrasives that will damage the finish of special wheel surfaces. Use a tar remover to remove grease and tar.

The brushes used in some automatic car washes may damage the finish on your wheels. Before going to a car wash, find out if the brushes are abrasive.

### Underbody

Flush the complete underside of vehicle frequently. Keep body drain holes unplugged. Inspect for road damage.

### Cleaning non-painted plastic exterior parts

Use vinyl cleaner for routine cleaning. Clean with a tar remover if necessary. Do not clean plastic parts with thinners, solvents or petroleum-based cleaners.

### Cleaning the exterior lamps

Wash with the same detergent as the exterior of your vehicle. If necessary, use a tar remover such as Ford Extra Strength Tar and Road Oil Remover (B7A-19520-AA).

To avoid scratching the lamps, do not use a dry paper towel, chemical solvents or abrasive cleaners.

## Maintenance and care

### Cleaning the wiper blades, windshield and rear window

If the wiper blades do not wipe properly, clean the wiper blade rubber element with undiluted windshield washer solution or a mild detergent. To avoid damaging the blades, do not use fuel, kerosene, paint thinner or other solvents.

If the wiper still does not wipe properly, this could be caused by substances on the windshield or rear window such as tree sap and some hot wax treatments used by commercial car washes. Clean the outside of the windshield or rear window with a non-abrasive cleaner such as Ford Ultra-Clear Spray Glass Cleaner, (E4AZ-19C507-AA), available from your Ford Dealer. **Do not** use abrasive cleansers on glass as they may cause scratches. The windshield or rear window is clean if beads do not form when you rinse it with water. The windshield, rear window and wiper blades should be cleaned on a regular basis, and blades or rubber elements replaced when worn.

### Cleaning seats equipped with side air bags

Remove dust and loose dirt with a whisk broom or a vacuum cleaner. Remove fresh spots immediately. Follow the directions that come with the cleaner. Do not saturate the seat cover with upholstery cleaner.



Do not use chemical solvents or strong detergents when cleaning the seat mounted side air bag. Such products could contaminate the side air bag system and affect performance of the side air bag in a collision.

### Cleaning the instrument panel

Clean with a damp cloth, then dry with a dry cloth.

Avoid cleaner or polish that increases the gloss of the upper portion of the instrument panel. The dull finish in this area helps protect the driver from undesirable windshield reflection.



Do not use chemical solvents or strong detergents when cleaning the steering wheel or instrument panel to avoid contamination of the air bag system.

## Maintenance and care

### ***Cleaning the instrument cluster lens***

Clean with a damp cloth, then dry with a dry cloth.

Do not use household or glass cleaners as these may damage the lens.

### **Cleaning the overhead console**

Clean with a damp cloth, then wipe dry with a dry cloth.

Avoid cleaner or polish that increases the gloss of the console. The dull finish in this area helps protect the driver from undesirable windshield reflection.

### **Cleaning the interior fabric**

Remove dust and loose dirt with a whisk broom or a vacuum cleaner.

Remove fresh spots immediately. Do not use household or glass cleaners. These agents can stain and discolor the fabric. Use a mild soap and water solution if necessary.

### **Cleaning and maintaining the safety belts**

Clean the safety belts with a mild soap solution recommended for cleaning upholstery or carpets. Do not bleach or dye the belts, because these actions may weaken the belt webbing.

Check the safety belt system periodically to make sure there are no nicks, wear or cuts. If your vehicle has been involved in an accident, refer to the *Safety belt maintenance* section in the *Seating and safety restraints* chapter.

### **Cleaning leather seats (if equipped)**

To clean, simply use a soft cloth dampened with water and a mild soap. Wipe the leather again with a damp cloth to remove soap residue. Dry with a soft cloth. For tougher soiling concerns, Ford recommends using the Deluxe Leather Care Kit F8AZ-19G253-AA, which is available from your Ford Dealer. This mild cleaner and special pad, cleans the leather and maintains its natural beauty. Follow the instructions on the cleaner label. Regular cleaning of your leather upholstery helps maintain its resiliency and color.

**Do not use household cleaning products, alcohol solutions, solvents or cleaners intended for rubber, vinyl or plastics.**

## Maintenance and care

### Woodtone trim

Wipe stains with a soft cloth and a multi-purpose cleaning solution.

### Inside windows

Use Ultra-Clear Spray Glass Cleaner (E4AZ-19C507-AA) for the inside windows if they become fogged.

### Cleaning mirrors

Do not clean your mirrors with a dry cloth or abrasive materials. Use a soft cloth and mild detergent and water. Be careful when removing ice from outside mirrors because you may damage the reflective surface.

## Capacities and specifications

### MOTORCRAFT PART NUMBERS

Component	4.0L SOHC V6 engine	5.0L V8 engine
Air filter element	FA-1658	FA-1658
Fuel filter	FG-986B	FG-986B
Battery	BXT-65-650	BXT-65-650
Oil filter	FL-1A	FL-820S
PCV valve	EV-225	EV-152
Spark plugs*	AGSF-22PP**	AWSF-32EE

\* Refer to Vehicle Emissions Control Information (VECI) decal for spark plug gap information.

\*\* If a spark plug is removed for inspection, it must be reinstalled in the same cylinder. If a spark plug needs to be replaced, use only spark plugs with the service number suffix letter as shown on the engine decal.

### REFILL CAPACITIES

Fluid	Ford Part Name	Application	Capacity
Brake fluid	High Performance DOT 3 Motor Vehicle Brake Fluid	All	Fill to line on reservoir
Engine oil (including filter change)	Motorcraft SAE 5W-20 Super Premium Motor Oil	5.0L	4.7L (5.0 quarts)
	Motorcraft SAE 5W-30 Super Premium Motor Oil	4.0L	4.7L (5.0 quarts)
Fuel tank	N/A	All	87.1L (22.5 gallons)
Power steering fluid	Motorcraft MERCON® ATF	All	Fill to line on reservoir or dipstick

## Capacities and specifications

Fluid	Ford Part Name	Application	Capacity
Transmission fluid <sup>1</sup>	Motorcraft MERCON®V ATF	4R70W Automatic with 5.0L V8 engine	13.1L (13.9 quarts) <sup>2</sup>
		5R55E Automatic with 4.0L SOHC V6 engine (4x2)	9.5L (10.0 quarts) <sup>2</sup>
		5R55E Automatic with 4.0L SOHC V6 engine (4x4)	9.8L (10.3 quarts) <sup>2</sup>
Transfer case	Motorcraft MERCON® ATF	4WD	1.4L (1.5 quarts)
		AWD	1.25L (1.3 quarts)
Engine coolant <sup>3</sup>	Premium Engine Coolant	4.0L SOHC V6 engine	15.4L (16.3 quarts)
		5.0L V8 engine	14.9L (15.7 quarts)
Front axle lubricant	Motorcraft SAE 80W-90 Premium Rear Axle Lubricant	4x4 vehicles	1.7L (1.8 quarts)
Rear axle lubricant <sup>4</sup>	Motorcraft SAE 80W-90 Premium Rear Axle Lubricant	Refer to Footnote 5	2.9-3.1L (5.5-5.8 pints)
	Motorcraft SAE 75W-140 High Performance Synthetic Rear Axle Lubricant	Refer to Footnote 6	
Windshield washer fluid	Ultra-Clear Windshield Washer Concentrate	All	2.6L (2.7 quarts)



## Capacities and specifications

<sup>1</sup> Ensure the correct automatic transmission fluid is used. Transmission fluid requirements are indicated on the dipstick or on the dipstick handle. MERCON® and MERCON® V are not interchangeable. DO NOT mix MERCON® and MERCON® V. Refer to your scheduled maintenance guide to determine the correct service interval.

<sup>2</sup> Indicates only approximate dry-fill capacity. Some applications may vary based on cooler size and if equipped with an in-tank cooler. The amount of transmission fluid and fluid level should be set by the indication on the dipstick's normal operating range.

<sup>3</sup> Use Ford Premium Engine Coolant (green in color). DO NOT USE Ford Extended Life Engine Coolant (orange in color). Refer to *Adding engine coolant, in the Maintenance and Care chapter*.

<sup>4</sup> Fill to 6 mm to 14 mm (1/4 inch to 9/16 inch) below bottom of fill hole.

<sup>5</sup> Vehicles equipped with 4.0L SOHC V6 engines may be equipped with a conventional rear axle. Refer to your scheduled maintenance guide for axle fluid change intervals.

<sup>6</sup> Vehicles equipped with 4.0L SOHC V6 engines and 3.73:1 or 4.10:1 rear axle ratios or with a 5.0L V8 engine require synthetic rear axle lubricant. Rear axles containing synthetic lubricant are lubricated for life. These lubricants are not to be checked or changed unless a leak is suspected or service is required. The axle lubricant should be changed any time the axle has been submerged in water.

Add 118 ml (4 oz.) of Additive Friction Modifier C8AZ-19B546-A or equivalent meeting Ford specification EST-M2C118-A for complete refill of Traction-Lok axles.

## Capacities and specifications

### LUBRICANT SPECIFICATIONS

Item	Ford Part Name or equivalent	Ford Part Number	Ford Specification
Body hinges, latches, door striker plates and rotors, seat tracks, fuel filler door hinge and spring, hood latch, auxiliary latch, seat tracks	Multi-Purpose Grease	D0AZ-19584-AA or F5AZ-19G209-AA	ESB-M1C93-B or ESR-M1C159-A
Hydraulic clutch fluid and brake fluid	High Performance DOT 3 Motor Vehicle Brake Fluid	C6AZ-19542-AB	ESA-M6C25-A and DOT 3
Driveshaft, slip spline, universal joints	Premium Long Life Grease	XG-1-C or XG-1-T or XG-1-K	ESA-M1C75-B
Engine coolant <sup>1</sup>	Ford Premium Engine Coolant	E2FZ-19549-AA (in Canada, Motorcraft CXC-10-c)	ESE-M97B44-A
Engine oil 5.0L V8	Motorcraft SAE 5W-20 Super Premium Motor Oil	XO-5W20-QSP	WSS-M2C153-H with API Certification Mark
Engine oil 4.0L SOHC V6	Motorcraft SAE 5W-30 Super Premium Motor Oil	XO-5W30-QSP	WSS-M2C153-G with API Certification Mark
Lock cylinders	Motorcraft penetrating and lock lubricant	Motorcraft XL-1	none
Automatic transmission <sup>2</sup>	Motorcraft MERCON®V ATF	XT-5-QM	MERCON®V
Power steering fluid	Motorcraft MERCON®ATF	XT-2-QDX	MERCON®

## Capacities and specifications

Item	Ford Part Name or equivalent	Ford Part Number	Ford Specification
Ford conventional and Traction-Lok rear axles	3, 4, 5	3, 4, 5	3, 4, 5
Front axle (4X4)	Motorcraft SAE 80W-90 Premium Rear Axle Lubricant	XY-80W90-QL	WSP-M2C197-A
Transfer case (4X4)	Motorcraft MERCON® ATF	XT-2-QDX	MERCON®
Transfer case Front Output Slip Shaft	Premium Long-Life Grease	XG-1-C or XG-1-T or XG-1-K	ESA-M1C75-B
Windshield washer fluid	Ultra-clear Windshield Washer Concentrate	C9AZ-19550-AC	ESR-M17P5-A

<sup>1</sup> DO NOT USE Ford Extended Life Engine Coolant F6AZ-19544-AA, meeting Ford specification WSS-M97B44-D (orange in color) Refer to *Adding engine coolant*, in the *Maintenance and Care* chapter.

<sup>2</sup> Ensure the correct automatic transmission fluid is used. Transmission fluid requirements are indicated on the dipstick or on the dipstick handle. MERCON® and MERCON® V are not interchangeable. DO NOT mix MERCON® and MERCON® V. Refer to your scheduled maintenance guide to determine the correct service interval.

<sup>3</sup> 4.0L vehicles with conventional rear axles are filled with Motorcraft SAE 80W-90 Premium Rear Axle Lubricant, part number XY-80W90-QL, Ford specification WSP-M2C197-A.

<sup>4</sup> 4.0L vehicles with limited slip differentials and all 5.0L applications use rear axles that are filled with Motorcraft SAE 75W-140 High Performance Synthetic Rear Axle Lubricant, part number F1TZ-19780-B or equivalent meeting Ford specification WSL-M2C192-A.

<sup>5</sup> 4.0L vehicles with limited slip differentials and all 5.0L applications must add 118 ml (4 oz) of Additive Friction Modifier C8AZ-19B546-A or equivalent meeting Ford specification EST-M2C118-A to the rear axle whenever the axle has been serviced.

## Capacities and specifications

### ENGINE DATA

Engine	4.0L SOHC V6 engine	5.0L V8 engine
Cubic inches	245	302
Required fuel	87 octane	87 octane
Firing order	1-4-2-5-3-6	1-3-7-2-6-5-4-8
Spark plug gap	1.3-1.4 mm (0.052-0.056 inch)	1.3-1.4 mm (0.052-0.056 inch)
Ignition system	EDIS	EDIS
Compression ratio	9.7:1	9.15:1

### VEHICLE DIMENSIONS

Dimensions	4-Door 4x2 or 4x4 XL Model mm (in.)
(1) Overall length	4 813 (189.5)
(2) Overall width	1 832 (72.1)
(3) Maximum height	1 817 (71.5)
(4) Wheelbase	2 889 (113.7)
(5) Front track	1 547 (60.9)
(5) Rear track	1 554 (61.2)

\* Height includes roof rack and P255 tire

## Capacities and specifications

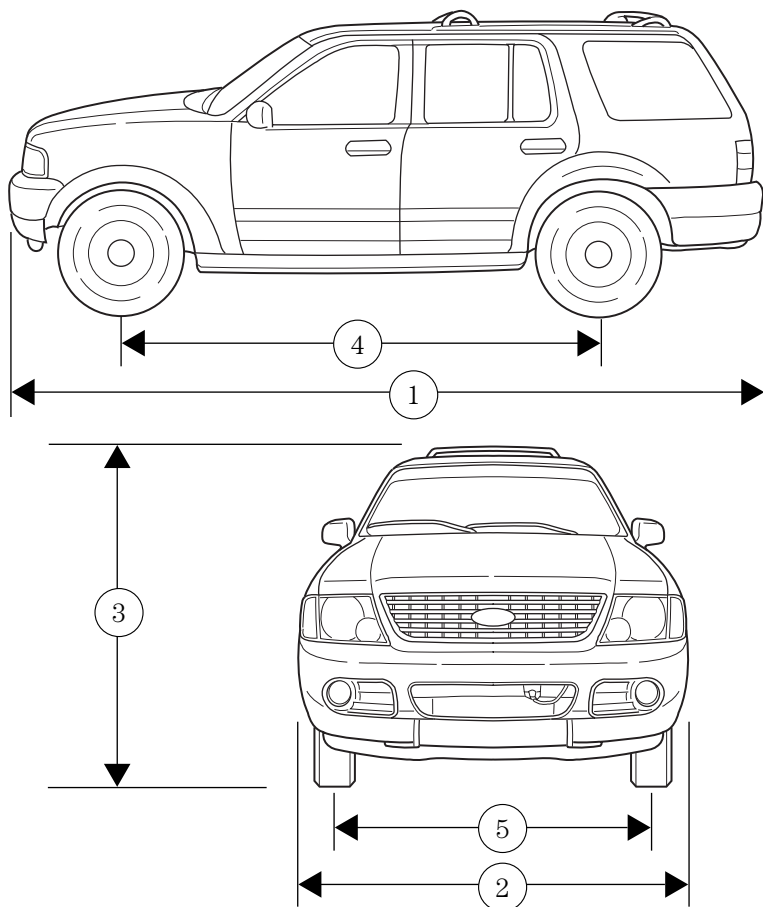

# Capacities and specifications

## IDENTIFYING YOUR VEHICLE

### Certification label

The National Highway Traffic Safety Administration Regulations require that a Certification Label be affixed to a vehicle and prescribe where the Certification Label may be located. The Certification Label is located on the front door latch pillar on the driver's side.

<b>MFD. BY FORD MOTOR CO. IN U.S.A.</b>			
DATE: XXXXX	GVWR: XXXXX LB/ XXXXX KG		
FGAWR: XXXXX/ XXXXXX	RGAWR: XXXXX/ XXXXXX		
THIS VEHICLE CONFORMS TO ALL APPLICABLE FEDERAL MOTOR VEHICLE SAFETY STANDARDS IN EFFECT ON THE DATE OF MANUFACTURE SHOWN ABOVE.			
VIN: XXXXXXXXXXXXXXXXX		TYPE: XXXXXXXXXXXXXXXXX	
			
MAXIMUM LOAD=OCCUPANTS + LUGGAGE= XXXKG/ XXXLB			
OCCUPANTS: X TOTAL X FR X 2ND X RR		OCCUPANTS LUGGAGE	
		XX XXXKG/ XXXLB	
TIRE: XXXX/ XXXX XXX		X XXXKG/ XXXLB	
PRESSURE (FR) XXX kPa/ 33 PSI COLD			
PRESSURE (RR) XXX kPa/ 33 PSI COLD			
TRAILER TOWING: SEE OWNER GUIDE			
EXT PNT: XXXXX XXXXX	RC: XX	DSC: XXXX	F0000
BAR   INT TR   TP/PS   R   AXLE   TR   SPR   T0000			
X   XX   XXX   X   XX   X   XXXX			
UTC VFOHT-15294A10-GA			

### Vehicle identification number

The vehicle identification number is attached to a metal tag and is located on the driver side instrument panel. (Please note that in the graphic XXXX is representative of your vehicle identification number.)

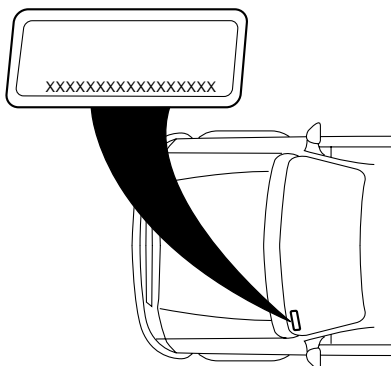

### Engine number

The engine number (the last eight numbers of the vehicle identification number) is stamped on the engine block, transmission, frame and transfer case (if equipped).

## Customer assistance

### Ford Extended Service Plan

You can get more protection for your new car or light truck by purchasing Ford Extended Service Plan (Ford ESP) coverage. Ford ESP is an optional service contract which is backed by Ford Motor Company or Ford Motor Service Company (in the U.S.) and Ford of Canada (in Canada). It provides the following:

- benefits during the warranty period depending on the plan you purchase (such as: reimbursement for rentals; coverage for certain maintenance and wear items)
- protection against repair costs after your Bumper to Bumper Warranty expires

You may purchase Ford ESP from any participating Ford and Lincoln Mercury and Ford of Canada dealer. There are several plans available in various time, distance and deductible combinations which can be tailored to fit your own driving needs. Ford ESP also offers reimbursement benefits for towing and rental coverage. (In Hawaii, rules vary. See your dealer for details.)

When you buy Ford ESP, you receive Peace-of-Mind protection throughout the United States and Canada, provided by a network of more than 5,000 participating Ford or Lincoln Mercury and Ford of Canada dealers.

If you did not take advantage of the Ford Extended Service Plan at the time of purchasing your vehicle, you may still be eligible. Please contact your dealer for further information. Since this information is subject to change, please ask your dealer for complete details about Ford Extended Service Plan coverage options, or visit the Ford ESP website at [www.ford-esp.com](http://www.ford-esp.com).

### Getting the service you need

#### At home

Ford Motor Company and Ford of Canada have authorized dealerships to service your vehicle. When you need warranty repairs your selling dealer would like you to return to it for that service, but you may also take your vehicle to another Ford Motor Company or Ford of Canada dealership authorized for warranty repairs. Certain warranty repairs require special training though, so not all dealers are authorized to perform all warranty repairs. That means that depending on the warranty repair needed, the vehicle may need to be taken to another dealer. If a particular dealership can not assist you, then contact the Customer Relationship Center.

## Customer assistance

If you have questions or concerns, or are unsatisfied with the service you are receiving, follow these steps:

1. Contact your Sales Representative or Service Advisor at your selling/servicing dealership.
2. If your inquiry or concern remains unresolved, contact the Sales Manager or Service Manager at the dealership.
3. If the inquiry or concern cannot be resolved at the dealership level, please contact the Ford Customer Relationship Center.

Ford Motor Company and Ford of Canada dealerships also carry quality parts and accessories, providing you with equipment reliability.

### Away from home

If you own a Ford or Mercury vehicle and are away from home when your vehicle needs service, or if you need more help than the dealership could provide, after following the steps described above, contact the Ford Customer Relationship Center to find an authorized dealership to help you. In the United States:

Ford Motor Company  
Customer Relationship Center  
16800 Executive Plaza Drive  
P.O. Box 6248  
Dearborn, Michigan 48121  
1-800-392-3673 (FORD)  
(TDD for the hearing impaired: 1-800-232-5952)

In Canada:  
Customer Relationship Centre  
Ford Motor Company of Canada, Limited  
P.O. Box 2000  
Oakville, Ontario L6J 5E4  
1-800-565-3673 (FORD)



## Customer assistance

If you own a Lincoln vehicle and are away from home when your vehicle needs service, or if you need more help than the dealership could provide, after following the steps described above, contact the Ford Customer Relationship Center to find an authorized dealership to help you. In the United States:

Ford Motor Company  
Customer Relationship Center  
16800 Executive Plaza Drive  
P.O. Box 6248  
Dearborn, Michigan 48121  
1-800-521-4140  
(TDD for the hearing impaired: 1-800-232-5952)

In Canada:  
Customer Relationship Centre  
Ford Motor Company of Canada, Limited  
P.O. Box 2000  
Oakville, Ontario L6J 5E4  
1-800-565-3673 (FORD)

In order to help you service your Ford or Lincoln Mercury vehicle, please have the following information available when contacting a Customer Relationship Center:

- Your telephone number (home and business)
- The name of the dealer and the city where the dealership is located
- The year and make of your vehicle
- The date of vehicle purchase
- The current odometer reading
- The vehicle identification number (VIN)

If you still have a complaint involving a warranty dispute, you may wish to contact the Dispute Settlement Board (U.S.) or the Canadian Motor Vehicle Arbitration Plan (CAMVAP), available in all of Canada (except Quebec).

In some states (in the U.S.) you must directly notify Ford in writing before pursuing remedies under your state's warranty laws. Ford is also allowed a final repair attempt in some states.

## Customer assistance

In the United States, a warranty dispute must be submitted to the Dispute Settlement Board before taking action under the Magnuson-Moss Warranty Act, or to the extent allowed by state law, before pursuing replacement or repurchase remedies provided by certain state laws. This dispute handling procedure is not required prior to enforcing state created rights or other rights which are independent of the Magnuson-Moss Warranty Act or state replacement or repurchase laws.

### **THE DISPUTE SETTLEMENT BOARD (U.S. only)**

The Dispute Settlement Board is:

- an independent, third-party arbitration program for warranty disputes
- available free to owners and lessees of qualifying Ford Motor Company vehicles

The Dispute Settlement Board may not be available in all states. Ford Motor Company reserves the right to change eligibility limitations, modify procedures and/or to discontinue this service without notice and without incurring obligations per applicable state law.

### **What kinds of cases does the Board review?**

Unresolved warranty repair concerns or vehicle performance as designed concerns on Ford and Lincoln Mercury cars and Ford and Lincoln Mercury light trucks which are within the terms of any applicable written new vehicle warranty are eligible for review, except those involving:

- a non-Ford product
- a non-Ford dealership
- sales disputes between customer and dealer except those associated with warranty repairs or concerns with the vehicle's performance as designed
- a request for reimbursement of consequential expenses unless a service or product concern is being reviewed
- items not covered by the New Vehicle Limited Warranty (including maintenance and wear items)
- alleged personal injury/property damage claims
- cases currently in litigation
- vehicles not used primarily for family, personal or household purposes (except in states where the Dispute Settlement Board is required to review commercial vehicles)
- vehicles with non-U.S. warranties

## Customer assistance

Concerns are ineligible for review if the New Vehicle Limited Warranty has expired at receipt of your application and, in certain states eligibility is dependent upon the customer's possession of the vehicle.

Eligibility may differ according to state law. For example, see the unique brochures for California, West Virginia, Georgia and Wisconsin purchasers/lessees.

### **Board membership**

The Board consists of:

- three consumer representatives
- a Ford or Lincoln Mercury dealership representative

Consumer candidates for Board membership are recruited and trained by an independent consulting firm. The dealership Board member is chosen from Ford and Lincoln Mercury dealership management, recognized for their business leadership qualities.

### ***What the Board needs***

To have your case reviewed you must complete the application in the DSB brochure and mail it to the address provided on the application form. Some states will require you to use certified mail, with return receipt requested.

Your application is reviewed and, if it is determined to be eligible, you will receive an acknowledgment indicating:

- the file number assigned to your application
- the toll-free phone number of the DSB's independent administrator

Your dealership and a Ford Motor Company representative will then be asked to submit statements.

To properly review your case, the Board needs the following information:

- legible copies of all documents and maintenance or repair orders relevant to the case
- the year, make, model, and Vehicle Identification Number (VIN) listed on your vehicle ownership license
- the date of repair(s) and mileage at the time of occurrence(s)
- the current mileage
- the name of the dealer(s) who sold or serviced the vehicle
- a brief description of your unresolved concern

## Customer assistance

- a brief summary of the action taken by the dealer(s) and Ford Motor Company
- the names (if known) of all the people you contacted at the dealership(s)
- a description of the action you expect to resolve your concern

You will receive a letter of explanation if your application does not qualify for Board review.

### ***Oral presentations***

If you would like to make an oral presentation, indicate YES to question #6 on the application. While it is your right to make an oral presentation before the Board, this is not a requirement and the Board will decide the case whether or not an oral presentation is made. Oral presentation may be requested by the Board as well.

### ***Making a decision***

Board members review all available information related to each complaint, including oral presentations, and arrive at a fair and impartial decision. Board review may be terminated at any time by either party.

Every effort is made to decide the case within 40 days of the date that all requested information is received by the Board. Since the Board generally meets once a month, it may take longer for the Board to consider some cases.

After a case is reviewed, the Board mails you a decision letter and a form on which to accept or reject the Board's decision. The decisions of the Board are binding on Ford (and, in some cases, on the dealer) but not on consumers who are free to pursue other remedies available to them under state or federal law.

### **To Request a DSB Brochure/Application**

For a brochure/application, speak to your dealer or write/call to the Board at the following address/phone number:

Dispute Settlement Board  
P.O. Box 5120  
Southfield, MI 48086-5120  
1-800-428-3718

## Customer assistance

You may also contact the North American Customer Relationship Center at 1-800-392-3673 (Ford), TDD for the hearing impaired: 1-800-232-5952 or by writing to the Center at the following address:

Ford Motor Company  
Customer Relationship Center  
16800 Executive Plaza Drive  
P.O. Box 6248  
Dearborn, Michigan 48121

### **UTILIZING THE MEDIATION/ARBITRATION PROGRAM (CANADA ONLY)**

In those cases where you continue to feel that the efforts by Ford and the dealer to resolve a factory-related vehicle service concern have been unsatisfactory, Ford of Canada participates in an impartial third party mediation/arbitration program administered by the Canadian Motor Vehicle Arbitration Plan (CAMVAP).

The CAMVAP program is a straight-forward and relatively speedy alternative to resolve a disagreement when all other efforts to produce a settlement have failed. This procedure is without cost to you and is designed to eliminate the need for lengthy and expensive legal proceedings.

In the CAMVAP program, impartial third-party arbitrators conduct hearings at mutually convenient times and places in an informal environment. These impartial arbitrators review the positions of the parties, make decisions and, when appropriate, render awards to resolve disputes. CAMVAP decisions are fast, fair, and final; the arbitrator's award is binding both to you and Ford of Canada.

CAMVAP services are available in all territories and provinces, except Quebec. For more information, without charge or obligation, call your CAMVAP Provincial Administrator directly at 1-800-207-0685.

### **GETTING ASSISTANCE OUTSIDE THE U.S. AND CANADA**

Before exporting your vehicle to a foreign country, contact the appropriate foreign embassy or consulate. These officials can inform you of local vehicle registration regulations and where to find unleaded fuel.

If you cannot find unleaded fuel or can only get fuel with an anti-knock index lower than is recommended for your vehicle, contact a district or owner relations/customer relationship office.

## Customer assistance

The use of leaded fuel in your vehicle without proper conversion may damage the effectiveness of your emission control system and may cause engine knocking or serious engine damage. Ford Motor Company/Ford of Canada is not responsible for any damage caused by use of improper fuel.

In the United States, using leaded fuel may also result in difficulty importing your vehicle back into the U.S.

If your vehicle must be serviced while you are traveling or living in Central or South America, the Caribbean, or the Middle East, contact the nearest Ford dealership. If the dealership cannot help you, write or call:

FORD MOTOR COMPANY  
WORLDWIDE DIRECT MARKET OPERATIONS  
1555 Fairlane Drive  
Fairlane Business Park #3  
Allen Park, Michigan 48101  
U.S.A.  
Telephone: (313) 594-4857  
FAX: (313) 390-0804

If you are in another foreign country, contact the nearest Ford dealership. If the dealership employees cannot help you, they can direct you to the nearest Ford affiliate office.

If you buy your vehicle in North America and then relocate outside of the U.S. or Canada, register your vehicle identification number (VIN) and new address with Ford Motor Company Worldwide Direct Market Operations.

### **FORD CAR CARE PRODUCTS FOR YOUR VEHICLE**

Ford has many quality products available from your dealer to clean your vehicle and protect its finishes. These quality products have been specifically engineered to fulfill your automotive needs; they are custom designed to complement the style and appearance of your vehicle. Each product is made from high quality materials and that meet or exceed Ford's rigid specifications. For best results, use the following or products of equivalent quality:

Ford Custom Clearcoat Polish\*

Ford Custom Silicone Gloss Polish

Ford Custom Vinyl Protectant\* (not available in Canada)

Motorcraft Vinyl Conditioner (Canada only)

## Customer assistance

Ford Deluxe Leather and Vinyl Cleaner (not available in Canada)

Motorcraft Vinyl Cleaner (Canada only)

Ford Extra Strength Tar and Road Oil Remover\* (not available in Canada)

Ford Extra Strength Upholstery Cleaner (Canada only)

Ford Extra Strength Upholstery Cleaner (not available in Canada)

Ford Metal Surface Cleaner

Ford Multi-Purpose Cleaner\*

Motorcraft Car Wash Concentrate

Motorcraft Carlite Glass Cleaner

Ford Spot and Stain Remover\*

Ford Super Premium Tire and Trim Dressing

Ford Triple Clean

Ford Ultra-Clear Spray Glass Cleaner (not available in Canada)

\* May be sold with the Motorcraft name

### **FORD ACCESSORIES FOR YOUR VEHICLE**

A wide selection of Ford accessories are available for your vehicle through your local authorized Ford, Lincoln Mercury or Ford of Canada dealer. These quality accessories have been specifically engineered to fulfill your automotive needs; they are custom designed to complement the style and aerodynamic appearance of your vehicle. In addition, each accessory is made from high quality materials and meets or exceeds Ford's rigid engineering and safety specifications. Ford accessories are warranted for up to 12 months or 20 000 km (12 000 miles) on all cars and light trucks and 12 months with unlimited distance on medium/heavy duty trucks unless the accessory is installed on a new vehicle, then the warranty becomes the balance of the new vehicle's warranty or the accessories warranty, whichever is greater. See your dealer for complete warranty information and availability.

**Not all accessories are available for all models.**

### **Vehicle Security**

Styled wheel locks

Vehicle security systems

## Customer assistance

### Comfort and convenience

Cargo net  
Cargo organizers  
Cargo shade  
Cargo tray  
Engine block heaters  
Tire step

### Travel equipment

Automatic headlamps with daytime running lights (DRL)  
Cellular phone holder  
Daytime running lights (DRL)  
Factory luggage rack adaptors (bike and ski)  
Heavy-duty battery  
Home link visor  
Inside mirror, electrochromic compass (with and without temperature display)  
Luggage/Cargo basket  
Luggage rack cross bars  
Neutral towing transfer case kit  
Dog guard  
Removable luggage rack adapters (bike and ski)  
Running boards/bars  
Seatback storage  
Smoker's package  
Soft luggage cover  
Track rider bars (for luggage rack)  
Trailer hitch (Class III)  
Trailer hitch bars and balls  
Trailer hitch mount bike carrier  
Trailer hitch receiver cover  
Trailer hitch wiring adaptor



### Protection and appearance equipment

Air bag anti-theft locks

Cargo liners, interior

Carpet floor mats

Cleaners, waxes and polishes

Door edge guards

Front end covers (full and sport)

Bug deflectors

Instrument panel trim (simulated wood)

Locking gas cap

Lubricants and oils

Molded splash guards

Molded vinyl floor mats

Rear spoiler

Side window air deflectors

Skid plate

Touch-up paint

Tow hooks

Truck cover

Universal floor mats

For maximum vehicle performance, keep the following information in mind when adding accessories or equipment to your vehicle:

- When adding accessories, equipment, passengers and luggage to your vehicle, do not exceed the total weight capacity of the vehicle or of the front or rear axle (GVWR or GAWR as indicated on the Safety compliance certification label). Consult your dealer for specific weight information.
- The Federal Communications Commission (FCC) and Canadian Radio Telecommunications Commission (CRTC) regulate the use of mobile communications systems - such as two-way radios, telephones and theft alarms - that are equipped with radio transmitters. Any such equipment installed in your vehicle should comply with FCC or CRTC regulations and should be installed only by a qualified service technician.

## Customer assistance

- Mobile communications systems may harm the operation of your vehicle, particularly if they are not properly designed for automotive use or are not properly installed. When operated, such systems may cause the engine to stumble or stall or cause the transmission to be damaged or operate improperly. In addition, such systems may be damaged or their performance may be affected by operating your vehicle. (Citizens band [CB] transceivers, garage door openers and other transmitters with outputs of five watts or less will not ordinarily affect your vehicle's operation.)
- Ford cannot assume responsibility for any adverse effects or damage that may result from the use of such equipment.

### ORDERING ADDITIONAL OWNER'S LITERATURE

To order the publications in this portfolio:

Make checks payable to:

HELM, INCORPORATED  
P.O. Box 07150  
Detroit, Michigan 48207

**For a free publication catalog, order toll free: 1-800-782-4356**

Monday-Friday 8:00 a.m. - 6:00 p.m. EST,  
for credit card holders only

### Obtaining a French owner's guide

French Owner's Guides can be obtained from your dealer or by writing to Ford Motor Company of Canada, Limited, Service Publications, P.O. Box 1580, Station B, Mississauga, Ontario L4Y 4G3.

## Reporting safety defects

### REPORTING SAFETY DEFECTS (U.S. ONLY)

If you believe that your vehicle has a defect that could cause a crash, or could cause injury or death, you should immediately inform the National Highway Traffic Safety Administration (NHTSA) in addition to notifying Ford Motor Company.

*Ford Motor Company*

If NHTSA receives similar complaints, it may open an investigation, and if it finds that a safety defect exists in a group of vehicles, it may order a recall and remedy campaign. However, NHTSA cannot become involved in individual problems between you, your dealer or Ford Motor Company.

To contact NHTSA, you may either call the Auto Safety Hotline toll-free at 1-800-424-9393 (202-366-0123 in the Washington D.C. area) or write to:

NHTSA  
U.S. Department of Transportation  
400 Seventh Street  
Washington D.C. 20590

You can also obtain other information about motor vehicle safety from the Hotline.

# Index

## A

Air bag supplemental restraint system .....137, 141  
    and child safety seats .....139  
    description .....137, 141  
    disposal .....144  
    driver air bag .....139, 142  
    indicator light .....10, 141, 143  
    operation .....139, 142  
    passenger air bag .....139, 142  
    side air bag .....141  
Air cleaner filter .....255  
Air conditioning .....23  
    automatic temperature control system .....27  
    rear seat controls .....32  
Air suspension .....160  
    description .....160  
    warning light .....12  
All Wheel Drive (AWD), driving off road .....173  
Ambulance packages .....3  
Antifreeze (see Engine coolant) .....216  
Anti-lock brake system (see Brakes) .....157–158  
Anti-theft system  
    warning light .....11  
Armrests .....107  
Audio system (see Radio) .....36  
Automatic transmission  
    driving an automatic overdrive .....162, 165  
    fluid, adding .....222  
    fluid, checking .....222  
    fluid, refill capacities .....255

    fluid, specification .....260  
Auxiliary power point .....106

## Axle

    lubricant specifications ..258, 260  
    refill capacities .....255  
    traction lok .....175

## B

Battery .....225  
    acid, treating emergencies ....225  
    charging system warning light .....11  
    jumping a disabled battery ....199  
    maintenance-free .....225  
    replacement, specifications ..255  
    servicing .....225  
    voltage gauge .....16  
Belt minder .....133  
Brakes .....157  
    anti-lock .....157–158  
    anti-lock brake system (ABS)  
        warning light .....10, 158  
    brake warning light .....10  
    fluid, checking and adding ....214  
    fluid, refill capacities .....255  
    fluid, specifications .....258, 260  
    lubricant specifications ..258, 260  
    parking .....158  
    shift interlock .....161  
Break-in period .....3

## C

Capacities for refilling fluids ....255  
Cargo area shade .....108  
Cargo cover .....108  
CD changer .....78

## Index

- Certification Label .....262
- Child safety restraints .....145  
  child safety belts .....145
- Child safety seats .....145–146  
  attaching with tether straps ..149  
  in front seat .....147  
  in rear seat .....147
- Cleaning your vehicle .....248  
  engine compartment .....250  
  exterior .....250–251  
  exterior lamps .....251  
  instrument cluster lens .....253  
  instrument panel .....252  
  interior .....252–253  
  mirrors .....254  
  plastic parts .....251  
  safety belts .....253  
  washing .....249  
  waxing .....249  
  wheels .....251  
  windows .....254  
  wiper blades .....252  
  woodtone trim .....254
- Climate control (see Air conditioning or Heating) .....23
- Clock .....42, 48, 58, 71
- Compass, electronic .....94  
  calibration .....96  
  set zone adjustment .....95
- Console .....105  
  overhead .....92  
  rear .....106
- Controls  
  power seat .....122  
  steering column .....90
- Coolant  
  checking and adding .....216  
  refill capacities .....219, 255  
  specifications .....258, 260
- Cruise control (see Speed control) .....84
- Customer Assistance .....185  
  Ford accessories for your vehicle .....270  
  Ford Extended Service Plan ....263  
  Getting assistance outside the U.S. and Canada .....269  
  Getting roadside assistance ...185  
  Getting the service you need 263  
  Ordering additional owner's literature .....274  
  The Dispute Settlement Board .....266  
  Utilizing the Mediation/Arbitration Program .....269
- D**
- Daytime running lamps (see Lamps) .....22
- Defrost  
  rear window .....34
- Dipstick  
  automatic transmission fluid ....222  
  engine oil .....210
- Doors  
  door ajar warning .....12  
  lubricant specifications .....258
- Driveline universal joint and slip yoke .....225
- Driving under special conditions .....172, 174  
  mud .....171, 173–174  
  sand .....171, 174  
  snow and ice .....171–173, 175  
  through water .....171, 174, 178

# Index

## E

- Emergencies, roadside
  - jump-starting .....199
- Emission control system .....242
- Engine .....260
  - check engine/service engine soon light .....8
  - cleaning .....250
  - coolant .....216
  - idle speed control .....225
  - lubrication
    - specifications .....258, 260
  - refill capacities .....255
  - service points .....209–210
  - starting after a collision .....186
- Engine block heater .....154
- Engine oil .....210
  - checking and adding .....210
  - dipstick .....210
  - filter, specifications .....213, 255
  - recommendations .....213
  - refill capacities .....255
  - specifications .....258, 260
- Exhaust fumes .....155

## F

- Floor mats .....107
- Fluid capacities .....255
- Foglamps .....22
- Four-Wheel Drive vehicles ...12, 167
  - control trac .....34, 168
  - description .....168–169
  - driving off road .....170, 173
  - electronic shift .....34
  - preparing to drive your vehicle .....161

- Fuel .....234
  - calculating fuel economy ...18, 238
  - cap .....9, 237
  - capacity .....255
  - choosing the right fuel .....236
  - comparisons with EPA fuel economy estimates .....241
  - detergent in fuel .....237
  - filling your vehicle with fuel .....234, 237, 239
  - filter, specifications .....238, 255
  - fuel pump shut-off switch ....186
  - gauge .....16
  - improving fuel economy .....238
  - octane rating .....236, 260
  - quality .....236
  - running out of fuel .....237
  - safety information relating to automotive fuels .....234

- Fuses .....187, 189

## G

- Garage door opener .....92, 96
- Gas cap (see Fuel cap) .....9, 237
- Gas mileage (see Fuel economy) .....238
- Gauges .....13
  - battery voltage gauge .....16
  - engine coolant temperature gauge .....14
  - engine oil pressure gauge .....16
  - fuel gauge .....16
  - odometer .....15
  - speedometer .....14
  - tachometer .....15
  - trip odometer .....15
- GAWR (Gross Axle Weight Rating) .....176
  - calculating .....178

definition .....176  
 driving with a heavy load .....176  
 location .....176  
 GVWR (Gross Vehicle Weight Rating) .....176  
   calculating .....176, 178  
   definition .....176  
   driving with a heavy load .....176  
   location .....176

## H

Hazard flashers .....186  
 Head restraints .....121, 125  
 Headlamps .....22  
   aiming .....248  
   autolamp system .....101  
   bulb specifications .....248  
   daytime running lights .....22  
   flash to pass .....23  
   high beam .....11, 22  
   replacing bulbs .....244  
   turning on and off .....22  
   warning chime .....13  
 Heating .....23  
   heating and air conditioning system .....23  
 HomeLink universal transceiver (see Garage door opener) .....96–100  
 Hood .....208

## I

Ignition .....83, 260  
 Infant seats (see Safety seats) .....145–146  
 Inspection/maintenance (I/M) testing .....243

Instrument panel  
   cleaning .....252  
   cluster .....8, 253  
   lighting up panel and interior .....23  
   location of components .....8

## J

Jack .....195  
   positioning .....195  
   storage .....195  
 Jump-starting your vehicle .....199

## K

Keyless entry system .....114  
   autolock .....116  
   keypad .....114  
   locking and unlocking doors .....115  
   programming entry code .....114  
 Keys .....117–119  
   key in ignition chime .....13  
   positions of the ignition .....83

## L

Lamps  
   bulb replacement specifications chart .....248  
   cargo lamps .....23  
   daytime running light .....22  
   fog lamps .....22  
   headlamps .....22  
   headlamps, flash to pass .....23  
   instrument panel, dimming .....23  
   replacing bulbs .....243–247  
 Lane change indicator (see Turn signal) .....83  
 Liftgate .....107  
 Lights, warning and indicator .....8

## Index

- air bag .....10
- anti-lock brakes (ABS) ....10, 158
- anti-theft .....11
- brake .....10
- charging system .....11
- check coolant .....11
- check engine .....8
- cruise indicator .....13
- door ajar .....12
- fuel cap light .....9
- high beam .....11
- overdrive off .....12
- safety belt .....10
- speed control .....88
- turn signal indicator .....11
- Load limits .....176
  - GAWR .....176
  - GVWR .....176
  - trailer towing .....176
- Loading instructions .....177
- Locks
  - autolock .....116
  - childproof .....104
- Lubricant specifications ...258, 260
- Lumbar support, seats ....124–125
- M**
- Manual transmission
  - fluid capacities .....255
  - lubricant specifications .....260
- Message center .....17
  - english/metric button .....17
  - reset button .....19
  - system check button .....19
- Mirrors
  - automatic dimming rearview
  - mirror .....102
  - cleaning .....254
  - fold away .....105
  - heated .....105
  - side view mirrors (power) ....104
- Moon roof .....93
- Motorcraft parts .....238, 255
- O**
- Octane rating .....236
- Odometer .....15
- Off-Road Driving .....173
- Oil (see Engine oil) .....210
- P**
- Panic alarm feature, remote entry system .....110
- Parking brake .....158
- Parts (see Motorcraft parts) ...255
- Power distribution box (see Fuses) .....192
- Power door locks .....103
- Power steering .....159
  - fluid, checking and adding ...220
  - fluid, refill capacity .....255
  - fluid, specifications .....258, 260
- Preparing to drive your vehicle .....161
- R**
- Radio .....36
- Relays .....187
- Remote entry system .....109–110
  - illuminated entry .....113
  - locking/unlocking doors .....110
  - panic alarm .....110



replacement/additional  
transmitters .....112  
replacing the batteries .....112  
Reverse sensing system .....34  
Roof rack .....184

## S

Safety belts (see Safety restraints) .....13, 127–132  
Safety defects, reporting .....275  
Safety restraints .....127–132  
  belt minder .....133  
  cleaning the safety  
  belts .....136, 253  
  extension assembly .....132  
  for adults .....128–131  
  for children .....144–145  
  warning light and  
  chime .....10, 13, 132–133  
Safety seats for children ..145–146  
Seat belts (see Safety restraints) .....127  
Seats .....121  
  child safety seats .....145–146  
  cleaning .....252–253  
  memory seat .....111, 124  
SecuriLock passive anti-theft system .....117–119  
Servicing your vehicle .....207  
Snowplowing .....3  
Spark plugs,  
specifications .....255, 260  
Special notice .....3  
  ambulance conversions .....3  
  utility-type vehicles .....3  
Specification chart,  
lubricants .....258, 260  
Speed control .....84  
Speedometer .....14  
Starting your vehicle .....152, 154  
  jump starting .....199  
Steering wheel  
  controls .....90  
  tilting .....89

## T

Tachometer .....15  
Tires .....195, 228–230  
  changing .....195–196  
  checking the pressure .....230  
  replacing .....232  
  rotating .....230  
  snow tires and chains .....233  
  tire grades .....230  
  treadwear .....229  
Towing .....178, 230  
  recreational towing .....183  
  trailer towing .....178  
  wrecker .....206  
Traction-lok rear axle .....175  
Transfer case  
  fluid checking .....224  
Transmission .....161  
  fluid, checking and adding  
  (automatic) .....222  
  fluid, refill capacities .....255  
  lubricant specifications ..258, 260  
Trip odometer .....15  
Turn signal .....11, 83

## Index

<b>V</b>	
Vehicle dimensions .....	260
Vehicle Identification Number (VIN) .....	262
Vehicle loading .....	176
Ventilating your vehicle .....	155
<b>W</b>	
Warning chimes .....	13
Warning lights (see Lights) .....	8
Washer fluid .....	215
Water, Driving through .....	178
Windows	
power .....	102
rear wiper/washer .....	90
Windshield washer fluid and wipers .....	90
checking and adding fluid ....	215
checking and cleaning .....	228
liftgate reservoir .....	216
operation .....	89
replacing wiper blades .....	228
Wrecker towing .....	206









## Filling station information

Item	Information
Required fuel	Unleaded fuel only - 87 octane
Fuel tank capacity (4 door)	75.5L (22.5 gallons)
4.0L Engine oil capacity (includes filter change)	4.7L (5.0 quarts). Use Motorcraft SAE 5W-30 Super Premium Motor Oil, Ford specification WSS-M2C153-G.
5.0L Engine oil capacity (includes filter change)	4.7L (5.0 quarts). Use Motorcraft SAE 5W-20 Super Premium Motor Oil, Ford specification WSS-M2C153-H.
Tire size and pressure	Refer to the Certification Label on inside of driver's door.
Hood release	Pull handle under the instrument panel.
Coolant capacity-(4.0L SOHC V6 engine) <sup>1</sup>	13.2L (14.0 quarts)
Coolant capacity (5.0L V8 engine) <sup>1</sup>	14.9L (15.7 quarts)
Power steering fluid capacity	Fill to line on reservoir or dipstick. Use Motorcraft MERCON® ATF.
Automatic transmission fluid capacity (4x2 <sup>2</sup> vehicles with 4.0L V6 engines) <sup>2</sup>	9.5L (10.0 quarts). Use Motorcraft MERCON® V ATF. <sup>3</sup>
Automatic transmission fluid capacity (4x4 vehicles with 5R55E and 4.0L V6 engines) <sup>2</sup>	9.8L (13.9 quarts). Use Motorcraft MERCON® V ATF. <sup>3</sup>
Automatic transmission fluid capacity (4R70W with 5.0L V8 engine) <sup>2</sup>	13.1L (10.0 quarts). Use Motorcraft MERCON® V ATF. <sup>3</sup>

<sup>1</sup> Use Ford Premium Engine Coolant (green in color). DO NOT USE Ford Extended Life Engine Coolant (orange in color). Refer to *Adding engine coolant, in the Maintenance and Care chapter*.

<sup>2</sup> Ensure the correct automatic transmission fluid is used. Transmission fluid requirements are indicated on the dipstick or on the dipstick handle. MERCON® and MERCON® V are not interchangeable. DO NOT mix MERCON® and MERCON® V. Refer to your scheduled maintenance guide to determine the correct service interval.

## Filling station information

<sup>3</sup> Indicates only approximate dry-fill capacity. Some applications may vary based on cooler size and if equipped with in-tank cooler. The amount of transmission fluid and fluid level should be set by the indication on the dipstick's normal operating range.