



Nozzles Catalogue

2013_{/12}



Automotive and marine nozzles

MADE IN ITALY



Index: *automotive and marine nozzles*

- American Bosch
- Baudouin
- Belarus-Kamaz
- Bendix
- Bosch
- Caterpillar
- Continental (Siemens)
- Cummins
- Delphi
- Denso
- Detroit Diesel
- Doowon
- F&M
- Fiat - Iveco
- Ford-Navistar
- Gardner
- GMT
- Hanshin
- IFA
- Leyland
- L'Orange
- Lucas-Bryce
- Lucas-Simms
- MaK
- MAN
- Motorpal
- OMAP
- Perkins
- Ruston
- Seven Diesel
- Sigma
- SKL
- Stanadyne
- Sulzer
- Titan
- Yanmar
- Zexel

CP = flow tested nozzle

DLC (Diamond-Like Carbon) = needle with special black coating

D/A = two diameter needle

Important notice. All the parts herein are manufactured by Seven Diesel S.p.A.. Other manufacturer's names, symbols, code numbers are quoted for reference purposes only and do not imply that any part listed in this catalogue is the product of these manufacturers.

Our Ref.	Stamping	Part Number	CP	DLC	D/A	Technical Data	Description
----------	----------	-------------	----	-----	-----	----------------	-------------

American Bosch

77963	ADB150S 103					4x0,33x150°	Nozzle
77970	ADB35S 124-7					1x0.45+1x0.40	Nozzle
77971	ADB135S 126-7					8x0,28x135°	Nozzle
77976	ADB155S 153-6					5x0,33x155°	Nozzle
77977	ADB155S 153-7					5x0,32x155°	Nozzle
77978	ADB150S 155-6					5x0,27x150°	Nozzle
77981	ADB30S 156-7					1x0.69x30°	Nozzle
77987	ADB135S 194-12					8x0,29x135°	Nozzle
NAB10421	ADL157TM 821-6					9x0,35x157°	Nozzle
NAB10422	ADL157TM 822-6					9x0,375x157°	Nozzle
NAB10427	ADL145TM 827-6	123x1053				9x0,375x145°	Nozzle
NAB10429	ADL145TM 829-6	22310227-2				9x0,35x145°	Nozzle
NAB10432	ADL145TM 830-6					9x0,40x145°	Nozzle
NAB10436	ADL145TM 836-6	H145T32K648				9x0,325x145°	Nozzle
NAB10440	ADL160TM 840-6	H160T37K904AP7				9x0,375x160°	Nozzle
NAB10442	ADL160TM 842-6	22310234				9x0,325x160°	Nozzle

Baudouin

NBN13246	1505 086 0F	DLLA145S 1018				8x0,25x145°	Nozzle
NBN13247	1505 085 0V	DLLA145S 1019				8x0,28x145°	Nozzle

Belarus-Kamaz

78000	11-1112110-A	BR 80				4x0,29x128°	Nozzle
78001	BR 90					3x0,32x140°	Nozzle
78002	H3TA	16-1112110-A				3x0,35x130°	Nozzle
78003	08-070					4x0,36x154°	Nozzle
78004	01-86-236					4x0,34x160°	Nozzle
78005	B3TA 5x0,32	B3TA				5x0,32x121°	Nozzle
78006	816633-8					4x0,35x154°	Nozzle
78007	07-79-236					4x0,39x146°	Nozzle
78008	04-93-26					4x0,35x152°	Nozzle
780086	06-90-26					4x0,35x152°	Nozzle
780088	174-02	02.10				5x0,34x123°	Nozzle
78009	271-01					4x0,35x146°	Nozzle
780093	273-20					5x0,31x151°	Nozzle
78010	19243					4x0,33x144°	Nozzle
78011C	BR171-02	05.07.A3NN				5x0,39x124°	Nozzle
78012	39-1112110-03					4x0,39x142°	Nozzle

Bendix

NBX60032	10-328310	123x1052				1x2,30	Nozzle
NBX60101	10-83547-2	123x1009				1x2.0	Nozzle

Bosch

40001	DN4S 1	0434 200 001					Pintle nozzle
40002	DN8S 1	0434 200 011					Pintle nozzle
400024	DN4S 2	0434 200 002					Pintle nozzle
400026	DN6S 2	0434 200 010					Pintle nozzle
400028	DN8S 2	0434 200 012					Pintle nozzle
40003	DN8S 3	0434 200 013					Pintle nozzle
40012	DN12SD 12	0434 250 027					Pintle nozzle
40021	DN0SD 21	0434 250 001					Pintle nozzle
40024	DN4SD 24	0434 250 014					Pintle nozzle
40126	DN0SD 126	0434 250 002					Pintle nozzle

<i>Our Ref.</i>	<i>Stamping</i>	<i>Part Number</i>	<i>CP</i>	<i>DLC</i>	<i>D/A</i>	<i>Technical Data</i>	<i>Description</i>
40130	DN0SD 130	0434 250 004					Pintle nozzle
40137	DN0SD 137	0434 250 005					Pintle nozzle
40138	DN8S 138	0434 200 998					Pintle nozzle
40149	DN0SD 149	0434 290 005					Pintle nozzle
40155	DN0SD 155	0434 290 006					Pintle nozzle
40156	DN15S 156	0434 200 021					Pintle nozzle
40162	DN4S 162	0434 200 028					Pintle nozzle
40165	DN0SD 165	0434 250 037					Pintle nozzle
40169	DN4SD 169	0434 250 041					Pintle nozzle
40174	DN0SD 174	0434 250 046					Pintle nozzle
40188	DN0SD 189	0434 250 060					Pintle nozzle
401891	DN0SD 189/	0434 250 122					Pintle nozzle
40193	DN0SD 193	0434 250 063					Pintle nozzle
40195	DN0SD 195	0434 250 065					Pintle nozzle
40197	DN6S 197	0434 200 034					Pintle nozzle
40203	DN0SD 203	0434 250 067					Pintle nozzle
40211	DN0SD 211	0434 250 009					Pintle nozzle
40216	DN0SD 216	0434 250 071					Pintle nozzle
40220	DN0SD 220	0434 250 072					Pintle nozzle
40221	DN12SD 221	0434 250 090					Pintle nozzle
40230	DN0SD 230	0434 250 077					Pintle nozzle
40240	DN0SD 240	0434 250 110					Pintle nozzle
40241	DN6S 241	0434 200 052					Pintle nozzle
40242	DN10S 242	0434 200 053					Pintle nozzle
40248	DN0SD 248	0434 250 105					Pintle nozzle
40252	DN0SD 252	0434 250 109					Pintle nozzle
402521	DN0SD 252+	0434 250 134					Pintle nozzle
402522	DN0SD 252+/ /	0434 250 164					Pintle nozzle
40253	DN0SD 253	0434 250 111					Pintle nozzle
40256	DN0SD 256	0434 250 114					Pintle nozzle
402561	DN0SD 256/ /	0434 250 135					Pintle nozzle
40259	DN0SD 259	0434 250 117					Pintle nozzle
40261	DN0SD 261	0434 250 120					Pintle nozzle
402621	DN0SD 262/ /	0434 250 121					Pintle nozzle
40263	DN0SD 263	0434 250 125					Pintle nozzle
40264	DN0SD 264	0434 250 127					Pintle nozzle
40265	DN0SD 265	0434 250 128					Pintle nozzle
40267	DN0SD 267	0434 250 130					Pintle nozzle
40269	DN0SD 269	0434 250 132					Pintle nozzle
40272	DN0SD 272	0434 250 137					Pintle nozzle
40273	DN0SD 273	0434 250 138					Pintle nozzle
40274	DN0SD 274	0434 250 139					Pintle nozzle
40282	DN0SD 282	0434 250 144					Pintle nozzle
40283	DN12SD 283	0434 250 145					Pintle nozzle
40286	DN0SD 286	0434 250 148					Pintle nozzle
40287	DN0SD 287	0434 250 149					Pintle nozzle
402871	DN0SD 287+	0434 250 157					Pintle nozzle
40288	DN0SD 288	0434 250 150					Pintle nozzle
40289	DN0SD 289	0434 250 156					Pintle nozzle
40290	DN12SD 290	0434 250 153					Pintle nozzle
40292	DN0SD 292	0434 250 154					Pintle nozzle
40293	DN0SD 293	0434 250 103					Pintle nozzle
40294	DN0SD 294	0434 250 155					Pintle nozzle
40296	DN12SD 296	0434 250 158					Pintle nozzle

<i>Our Ref.</i>	<i>Stamping</i>	<i>Part Number</i>	<i>CP</i>	<i>DLC</i>	<i>D/A</i>	<i>Technical Data</i>	<i>Description</i>
Bosch							
40297	DN0SD 297	0434 250 159					Pintle nozzle
40299	DN0SD 299	0434 250 160					Pintle nozzle
402991	DN0SD 299A	0434 250 171					Pintle nozzle
402992	DN0SD 299C	0434 250 193					Pintle nozzle
40300	DN0SD 300	0434 250 161					Pintle nozzle
40301	DN0SD 301	0434 250 162					Pintle nozzle
40302	DN0SD 302	0434 250 163					Pintle nozzle
403021	DN0SD 302A	0434 250 175					Pintle nozzle
40304	DN0SD 304	0434 250 898					Pintle nozzle
40305	DN0SD 305	0434 250 165					Pintle nozzle
40306	DN0SD 306	0434 250 167					Pintle nozzle
40308	DN0SD 308	0434 250 169					Nozzle 2 springs
40309	DN0SD 309	0434 250 170					Pintle nozzle
40310	DN0SD 310	0434 250 897					Pintle nozzle
40314	DN0SD 314	0434 250 176					Pintle nozzle
40315	DN0SD 315	0434 250 177					Pintle nozzle
40320	DN0SD 320	0434 250 224					Pintle nozzle
40321	DN0SD 321	0434 250 225					Pintle nozzle
40322	DN0SD 322	0434 250 226					Pintle nozzle
40510	DN0SD 1510	0434 250 011					Pintle nozzle
40550	DN0SD 1550	0434 290 014					Pintle nozzle
40750	DN12SD 1750	0434 250 119					Pintle nozzle
40930	DN0SD 1930	0434 250 092					Pintle nozzle
40940	DN0SD 2110	0434 250 012					Pintle nozzle
71000	DLL132S 1	0433 220 013				4x0,25x132°	Nozzle
71001	DLL150S 53	0433 270 020				4x0,24x150°	Nozzle
71002	DLL150S 60	0433 220 033				8x0,23x150°	Nozzle
71004	DLL110S 103	0433 270 004				3x0,28x110°	Nozzle
71005	DLL160S 136	0433 270 039				4x0,31x160°	Nozzle
710054L	DLL160S 154	0433 270 041				4x0,31x160°	Nozzle
71006	DLL140S 162	0433 220 020				5x0,30x140°	Nozzle
710075L	DLL150S 184	0433 220 058				6x0,31x150°	Nozzle
710076L	DLL150S 188	0433 220 060				7x0,26x150°	Nozzle
71008	DLL160S 202	0433 220 067				7x0,32x160°	Nozzle
71009	DLL150S 211	0433 220 063				4x0,29x150°	Nozzle
71010	DLL140S 217	0433 220 065				4x0,31x140°	Nozzle
71011	DLL150S 219	0433 220 064				5x0,35x150°	Nozzle
71012	DLL50S 226	0433 220 066				3x0,36+2x0,25	Nozzle
71013	DLL140S 248	0433 220 073				4x0,20x140°	Nozzle
71014	DLL145S 258	0433 270 071				4x0,35x145°	Nozzle
71015	DLL150S 267	0433 270 076				4x0,28x150°	Nozzle
710155	DLL50S 278	0433 220 078				3x0,44+2x0,32	Nozzle
71016	DLL120S 285	0433 220 079				6x0,42x120°	Nozzle
71017	DLL145S 317	0433 270 086				4x0,36x145°	Nozzle
71018L	DLL160S 336	0433 220 087				4x0,34x160°	Nozzle
710197	DLL160S 343	0433 220 091				6x0,41x160°	Nozzle
710198	DLL150S 344	0433 220 092				8x0,37x150°	Nozzle
71020	DLL160S 346	0433 220 093				9x0,42x160°	Nozzle
710202C	DLL150S 348	0433 220 095				4x0,39x150°	Nozzle
710217	DLL120S 352	0433 220 097				6x0,36x120°	Nozzle
71022	DLL18S 353	0433 270 102				1x0,57x18°	Nozzle
71025	DLL35S 364	0433 270 106				1x0,72x35°	Nozzle
71027	DLL150S 393	0433 270 114				4x0,30x150°	Nozzle
71028	DLL150S 405	0433 270 116				4x0,40x150°	Nozzle

<i>Our Ref.</i>	<i>Stamping</i>	<i>Part Number</i>	<i>CP</i>	<i>DLC</i>	<i>D/A</i>	<i>Technical Data</i>	<i>Description</i>
71029	DLL150S 406	0433 270 117				4x0,30x150°	Nozzle
71030	DLL18S 418	0433 270 121				1x0,61x18°	Nozzle
71032	DLL140S 446	0433 220 109				4x0,39x140°	Nozzle
71033	DLL150S 450	0433 220 110				4x0,30x150°	Nozzle
710334C	DLL150S 464	0433 220 113				4x0,43x150°	Nozzle
710343	DLL150S 508	0433 270 142				4x0,31x150°	Nozzle
71035	DLL140S 522	0433 270 146				4x0,37x140	Nozzle
710359	DLL153S 529	0433 220 123				8x0,28x153°	Nozzle
71036C	DLL150S 530	0433 220 124				5x0,33x150°	Nozzle
710371L	DLL150S 535	0433 220 126				7x0,29x150°	Nozzle
710372L	DLL180S 540	0433 270 148				4x0,29x180°	Nozzle
710375	DLL150S 545	0433 220 128				8x0,25x150°	Nozzle
71038	DLL23S 553	0433 220 129				1x0,61x23°	Nozzle
71039	DLL35S 559	0433 220 130				1x0,67x35°	Nozzle
71040	DLL38S 560	0433 220 131				1x0,72x38°	Nozzle
710401	DLL35S 561	0433 220 132				1x0,61x35°	Nozzle
710402	DLL35S 562	0433 220 133				1x0,66x35°	Nozzle
710406	DLL18S 572	0433 270 150				1x0,60x18°	Nozzle
71041	DLL140S 586	0433 220 140				4x0,42x140°	Nozzle
71042	DLL16S 592	0433 220 141				1x0,61x16°	Nozzle
710421	DLL150S 606	0433 220 143				4x0,42x150°	Nozzle
710423	DLL140S 610	0433 270 157				4x0,29x140°	Nozzle
710424	DLL150S 612	0433 270 159				4x0,25x150°	Nozzle
710427	DLL18S 629	0433 270 162				1x0,62x18°	Nozzle
710429	DLL150S 631	0433 220 147				8x0,31x150°	Nozzle
71043	DLL140S 632	0433 220 148				4x0,45x140°	Nozzle
710431	DLL25S 680	0433 270 168				1x0,38+1x0,43	Nozzle
71044L	DLL160S 705	0433 270 170				4x0,30x160°	Nozzle
710450	DLL160S 721	0433 220 155				4x0,37x160°	Nozzle
710451	DLL120S 736	0433 220 157				2x0,36+3x0,50	Nozzle
710452	DLL152S 756	0433 220 160				5x0,52x152°	Nozzle
710453	DLL152S 780	0433 220 163				5x0,55x152°	Nozzle
710456	DLL25S 834	0433 270 176				1x0,65x25°	Nozzle
71046	DLL28S 932	0433 270 182				1x0,71x28°	Nozzle
710462	DLL155S 942	0433 220 173				4x0,38x155°	Nozzle
710464	DLL110S 1030	9430 034 205				3x0,28x110°	Nozzle
710467	DLL155S 1057	0433 220 190				7x0,41x155°	Nozzle
710468L	DLL150S 1093	0433 220 195				8x0,32x150°	Nozzle
710469	DLL155S 1271	0433 270 191				8x0,31x155°	Nozzle
71047	DLL150S 2641	0433 270 120				4x0,29x150°	Nozzle
71048	DLL155S 4820	0433 270 161				5x0,33x155°	Nozzle
71056	DLLA154S 016	F019 122 016				4x0,315x154°	Nozzle
71060	DLLA27S 50	0433 271 013				2x0,41x27°	Nozzle
71070	DLLA27S 88	0433 271 016				2x0,42x27°	Nozzle
71071	DLLA20S 102	0433 271 005				2x0,36x20°	Nozzle
71072	DLLA150S 111	0433 271 027				4x0,31x150°	Nozzle
71075	DLLA38S 133	0433 271 022				2x0,52x38°	Nozzle
71076	DLLA10S 134	0433 271 001				2x0,42x10°	Nozzle
71077	DLLA150S 138	0433 271 030				4x0,36x150°	Nozzle
71078	DLLA150S 140	0433 271 032				4x0,31x150°	Nozzle
71079	DLLA23S 155	0433 271 008				1x0,53x23°	Nozzle
71080	DLLA35S 161	0433 271 021				1x0,60x35°	Nozzle
710805	DLLA35S 175	0433 271 041				1x0,66x35°	Nozzle
71081	DLLA150S 178	0433 271 043				4x0,35x150°	Nozzle

<i>Our Ref.</i>	<i>Stamping</i>	<i>Part Number</i>	<i>CP</i>	<i>DLC</i>	<i>D/A</i>	<i>Technical Data</i>	<i>Description</i>
71082	DLLA150S 186	0433 271 045				4x0,39x150°	Nozzle
71083	DLLA150S 187	0433 271 046				4x0,32x150°	Nozzle
71084	DLLA150S 190	0433 271 048				4x0,29x150°	Nozzle
71085	DLLA23S 191	0433 271 049				1x0,61x23°	Nozzle
71086	DLLA145S 199	0433 271 055				4x0,26x145°	Nozzle
71087	DLLA150S 204	0433 271 058				4x0,34x150°	Nozzle
710875	DLLA38S 208	0433 271 060				1x0,75x38°	Nozzle
71089	DLLA150S 223	0433 271 067				4x0,29x150°	Nozzle
71091	DLLA150S 236	0433 271 071				4x0,24x150°	Nozzle
71094	DLLA140S 254	0433 271 172				4x0,33x140°	Nozzle
71095L	DLLA160S 255	0433 271 079				4x0,29x160°	Nozzle
710961	DLLA150S 269	0433 271 086				4x0,35x150°	Nozzle
710964	DLLA150S 274	0433 271 092				3x0,45x150°	Nozzle
710967	DLLA10S 286	0433 271 099				2x0,42x10°	Nozzle
710968	DLLA150S 288	0433 271 100				4x0,24x150°	Nozzle
71097	DLLA150S 292	0433 271 103				5x0,33x150°	Nozzle
71098	DLLA38S 293	0433 271 104				1x0,70x38°	Nozzle
71099	DLLA28S 297	0433 271 106				1x0,43x28°	Nozzle
710995	DLLA140S 305	0433 271 112				4x0,28x140°	Nozzle
71100	DLLA153S 308	0433 271 114				4x0,29x153°	Nozzle
71101	DLLA28S 310	0433 271 117				1x0,61x28°	Nozzle
71102	DLLA28S 312	0433 271 118				1x0,56x28°	Nozzle
71110	DLLA35S 376	0433 271 150				1x0,70x35°	Nozzle
71111	DLLA35S 377	0433 271 151				1x0,71x35°	Nozzle
71112	DLLA160S 378	0433 271 152				4x0,26x160°	Nozzle
711124	DLLA23S 383	0433 271 155				1x0,61x23°	Nozzle
71113L	DLLA150S 386	0433 271 157				4x0,36x150°	Nozzle
71114	DLLA79S 390	0433 271 160				4x0,37x79°	Nozzle
71115L	DLLA150S 392	0433 271 161				3x0,36x150°	Nozzle
71116	DLLA149S 394	0433 271 162				4x0,29x149°	Nozzle
71117	DLLA150S 396	0433 271 164				3x0,29x150°	Nozzle
71118	DLLA150S 402	0433 271 169				4x0,42x150°	Nozzle
71119	DLLA28S 414	0433 271 177				2x0,48x28°	Nozzle
71120	DLLA150S 417	0433 271 180				4x0,31x150°	Nozzle
711209	DLLA150S 421	0433 271 183				4x0,37x150°	Nozzle
71121	DLLA150S 422	0433 271 184				3x0,33x150°	Nozzle
71123	DLLA28S 441	0433 271 201				2x0,44x28°	Nozzle
711231	DLLA150S 442	0433 271 195				4x0,32x150°	Nozzle
71125	DLLA150S 456	0433 271 205				4x0,32x150°	Nozzle
71126	DLLA150S 467	0433 271 212				4x0,31x150°	Nozzle
71127	DLLA150S 469	0433 271 214				4x0,29x150°	Nozzle
711275	DLLA150S 475	0433 271 217				4x0,31x150°	Nozzle
71128	DLLA144S 485	0433 271 221				4x0,38x144°	Nozzle
711288	DLLA144S 488	0433 271 222				4x0,40x144°	Nozzle
71129	DLLA149S 490	0433 271 223				4x0,30x149°	Nozzle
71130	DLLA150S 494	0433 271 224				5x0,25x150°	Nozzle
711305	DLLA150S 501	0433 271 229				4x0,29x150°	Nozzle
71131L	DLLA150S 506	0433 271 230				4x0,31x150°	Nozzle
711321	DLLA145S 507	0433 271 231				4x0,28x145°	Nozzle
71133	DLLA160S 509	0433 271 232				4x0,29x160°	Nozzle
71134	DLLA27S 512	0433 271 233				2x0,46x27°	Nozzle
711352L	DLLA150S 515	0433 271 236				3x0,39x150°	Nozzle
71136	DLLA27S 517	0433 271 238				1x0,65x27°	Nozzle
71138L	DLLA150S 523	0433 271 241				4x0,37x150°	Nozzle

<i>Our Ref.</i>	<i>Stamping</i>	<i>Part Number</i>	<i>CP</i>	<i>DLC</i>	<i>D/A</i>	<i>Technical Data</i>	<i>Description</i>
71139	DLLA160S 526	0433 271 244				5x0,31x160°	Nozzle
711391	DLLA150S 527	0433 271 245				4x0,30x150°	Nozzle
71140	DLLA152S 533	0433 271 246				4x0,27x152°	Nozzle
71141	DLLA38S 541	0433 271 252				1x0,75x38°	Nozzle
71142	DLLA150S 548	0433 271 258				5x0,32x150°	Nozzle
71143	DLLA150S 549	0433 271 259				5x0,27x150°	Nozzle
711435	DLLA150S 550	0433 271 260				4x0,32x150°	Nozzle
71144	DLLA155S 551	0433 271 261				4x0,23x155°	Nozzle
71145	DLLA160S 555	0433 271 263				4x0,29x160°	Nozzle
71147	DLLA160S 557	0433 271 265				5x0,25x160°	Nozzle
711473L	DLLA140S 563	0433 271 266				3x0,45x140°	Nozzle
71148	DLLA140S 567	0433 271 269				4x0,28x140°	Nozzle
711481	DLLA155S 568	0433 271 270				3x0,44x155°	Nozzle
71149	DLLA155S 574	0433 271 274				4x0,33x155°	Nozzle
711491L	DLLA160S 575	0433 271 275				4x0,40x160°	Nozzle
71150	DLLA150S 582	0433 271 280				4x0,41x150°	Nozzle
71151	DLLA150S 583	0433 271 281				4x0,27x150°	Nozzle
711519	DLLA150S 588	0433 271 284				4x0,30x150°	Nozzle
71152	DLLA28S 589	0433 271 285				1x0,58x28°	Nozzle
711521	DLLA155S 593	0433 271 287				3x0,41x155°	Nozzle
711529	DLLA28S 600	0433 271 292				2x0,46x28°	Nozzle
71153	DLLA25S 601	0433 271 293				1x0,64x25°	Nozzle
711531	DLLA150S 602	9430 084 202				5x0,47x150°	Nozzle
71154	DLLA150S 607	0433 271 294				4x0,30x150°	Nozzle
711541L	DLLA160S 608	0433 271 295				4x0,28x160°	Nozzle
71155	DLLA27S 613	0433 271 296				1x0,67x27°	Nozzle
71156	DLLA25S 614	0433 271 297				1x0,60x25°	Nozzle
71157	DLLA150S 615	0433 271 298				5x0,31x150°	Nozzle
71158	DLLA150S 616	0433 271 299				5x0,35x150°	Nozzle
71159	DLLA150S 618	0433 271 300				4x0,38x150°	Nozzle
71160	DLLA140S 619	0433 271 301				4x0,40x140°	Nozzle
711602C	DLLA150S 620					5x0,26x150°	Nozzle
711609	DLLA160S 626	0433 271 305				4x0,35x160°	Nozzle
71161	DLLA25S 627	0433 271 306				1x0,66x25°	Nozzle
711615	DLLA150S 628	0433 271 307				4x0,36x150°	Nozzle
71162	DLLA160S 630	0433 271 308				4x0,39x160°	Nozzle
711629	DLLA150S 633	0433 271 309				4x0,33x150°	Nozzle
71163	DLLA150S 634	0433 271 310				4x0,41x150°	Nozzle
71164	DLLA140S 637	0433 271 313				4x0,41x140°	Nozzle
711645L	DLLA160S 641	0433 271 315				4x0,36x160°	Nozzle
71166	DLLA155S 651	0433 271 318				5x0,32x155°	Nozzle
711663	DLLA150S 653	0433 271 319				4x0,36x150°	Nozzle
711669	DLLA142S 655	0433 271 321				4x0,39x142°	Nozzle
71167	DLLA28S 656	0433 271 322				2x0,45x28°	Nozzle
711681C	DLLA155S 658	0433 271 898				4x0,35x155°	Nozzle
711682L	DLLA141S 662	0433 271 325				3x0,35x141°	Nozzle
711684	DLLA150S 666	0433 271 327				4x0,39x150°	Nozzle
711686	DLLA150S 671	0433 271 329				4x0,29x150°	Nozzle
71169	DLLA140S 677	0433 271 333				5x0,28x140°	Nozzle
71170	DLLA30S 678	0433 271 334				1x0,75x30°	Nozzle
711701	DLLA150S 679	0433 271 335				4x0,43x150°	Nozzle
711703C	DLLA155S 681	0433 271 895				4x0,37x155°	Nozzle
711705L	DLLA160S 684	0433 271 338				4x0,36x160°	Nozzle
71171C	DLLA151S 686	0433 271 894				4x0,26x151°	Nozzle

<i>Our Ref.</i>	<i>Stamping</i>	<i>Part Number</i>	<i>CP</i>	<i>DLC</i>	<i>D/A</i>	<i>Technical Data</i>	<i>Description</i>
711721C	DLLA150S 690	0433 271 891				4x0,29x150°	Nozzle
711725C	DLLA155S 695	0433 271 890				4x0,41x155°	Nozzle
711725L	DLLA160S 699	0433 271 343				4x0,38x160°	Nozzle
711726C	DLLA152S 703	0433 271 886				4x0,28x152°	Nozzle
711731C	DLLA150S 704	0433 271 885				5x0,30x150°	Nozzle
711737L	DLLA160S 707	0433 271 344				4x0,29x160°	Nozzle
711742	DLLA150S 709	0433 271 354				4x0,32x150°	Nozzle
711743	DLLA155S 710	0433 271 884				4x0,31x155°	Nozzle
711747C	DLLA155S 713	0433 271 883				4x0,33x155°	Nozzle
711751	DLLA150S 714	0433 271 348				4x0,34x150°	Nozzle
711752L	DLLA149S 715	0433 271 349				3x0,41x149°	Nozzle
711753C	DLLA150S 716	0433 271 882				4x0,27x150°	Nozzle
711754	DLLA150S 718	0433 271 353				4x0,41x150°	Nozzle
71176	DLLA150S 720	0433 271 036				4x0,29x150°	Nozzle
71177	DLLA25S 722	0433 271 355				1x0,66x25°	Nozzle
711771	DLLA155S 723	0433 271 352				4x0,30x155°	Nozzle
711772	DLLA150S 724	0433 271 356				4x0,37x150°	Nozzle
711775C	DLLA150S 728	0433 271 879				4x0,30x150°	Nozzle
711776C	DLLA155S 729	0433 271 878				5x0,26x155°	Nozzle
71179	DLLA155S 733	0433 271 359				4x0,36x155°	Nozzle
711798C	DLLA150S 739	0433 271 874				5x0,31x150°	Nozzle
711801C	DLLA150S 741	0433 271 873				4x0,31x150°	Nozzle
71181	DLLA24S 745	0433 271 363				1x0,53x24°	Nozzle
71182	DLLA144S 747	0433 271 366				4x0,38x144°	Nozzle
71183	DLLA34S 749	0433 271 365				1x0,70x34°	Nozzle
71184C	DLLA150S 753	0433 271 868				5x0,35x150°	Nozzle
71185C	DLLA150S 754	0433 271 867				5x0,27x150°	Nozzle
711861C	DLLA160S 760	0433 271 866				4x0,31x160°	Nozzle
711862C	DLLA150S 762	0433 271 865				4x0,41x150°	Nozzle
711872C	DLLA158S 766	0433 271 864				4x0,28x158°	Nozzle
711881C	DLLA150S 767	0433 271 863				6x0,32x150°	Nozzle
711884	DLLA145S 770	0433 271 375				4x0,32x145°	Nozzle
71190	DLLA150S 773	0433 271 204				4x0,31x150°	Nozzle
71191	DLLA149S 774	0433 271 376				4x0,30x149°	Nozzle
71192	DLLA149S 775	0433 271 377				4x0,32x149°	Nozzle
711922	DLLA150S 777	0433 271 379				4x0,41x150°	Nozzle
71193	DLLA150S 781	0433 271 394				4x0,41x150°	Nozzle
711932C	DLLA152S 783	0433 271 861				6x0,275x152°	Nozzle
71194	DLLA140S 786	0433 271 395				4x0,39x140°	Nozzle
711942	DLLA160S 787	0433 271 396				4x0,27x160°	Nozzle
71195C	DLLA150S 789	0433 271 859				4x0,37x150°	Nozzle
71196	DLLA142S 791	0433 271 403				4x0,31x142°	Nozzle
71197	DLLA142S 792	0433 271 404				4x0,33x142°	Nozzle
711971	DLLA150S 793	0433 271 398				4x0,43x150°	Nozzle
711975C	DLLA150S 798	0433 271 857				3x0,30x150°	Nozzle
711981C	DLLA150S 804	0433 271 856				4x0,31x150°	Nozzle
711982CL	DLLA150S 806	0433 271 855				4x0,30x150°	Nozzle
71199	DLLA144S 808	0433 271 410				4x0,33x144°	Nozzle
711991	DLLA35S 812	0433 271 413				1x0,51x35°	Nozzle
71200C	DLLA151S 813	0433 271 850				4x0,29x151°	Nozzle
71201C	DLLA150S 815	0433 271 849				4x0,30x150°	Nozzle
712026C	DLLA150S 816	0433 271 848				4x0,35x150°	Nozzle
71202C	DLLA160S 817	0433 271 847				4x0,32x160°	Nozzle
71204C	DLLA156S 822	0433 271 845				4x0,27x156°	Nozzle

<i>Our Ref.</i>	<i>Stamping</i>	<i>Part Number</i>	<i>CP</i>	<i>DLC</i>	<i>D/A</i>	<i>Technical Data</i>	<i>Description</i>
71205C	DLLA140S 827	0433 271 843				4x0,31x140°	Nozzle
71206C	DLLA150S 828	0433 271 842				2x0,23+2x0,25	Nozzle
71207	DLLA144S 829	0433 271 423				4x0,41x144°	Nozzle
712071C	DLLA150S 830	0433 271 841				3x0,37x150°	Nozzle
712073	DLLA155S 833	9430 034 227				4x0,25x155°	Nozzle
712079C	DLLA155S 835	0433 271 839				4x0,36x155°	Nozzle
71208C	DLLA150S 836	0433 271 838				4x0,29x150°	Nozzle
71209	DLLA34S 837	0433 271 421				1x0,60x34°	Nozzle
71209C	DLLA150S 838	0433 271 837				5x0,37x150°	Nozzle
71210C	DLLA144S 842	0433 271 835				4x0,37x144°	Nozzle
71211C	DLLA150S 843	0433 271 834				4x0,32x150°	Nozzle
71212	DLLA145S 847	0433 271 424				4x0,34x145°	Nozzle
71212C	DLLA150S 851/	0433 271 730				5x0,32x150°	Nozzle
71213	DLLA150S 852	0433 271 425				4x0,32x150°	Nozzle
712131C	DLLA150S 853	0433 271 829				5x0,37x150°	Nozzle
712132C	DLLA155S 858	0433 271 825				4x0,39x155°	Nozzle
712134	DLLA148S 862	0433 271 428				4x0,30x148°	Nozzle
712135C	DLLA150S 870	0433 271 823				4x0,34x150°	Nozzle
712142	DLLA150S 873	0433 271 434				4x0,32x150°	Nozzle
712145	DLLA34S 876	0433 271 435				1x0,71x34°	Nozzle
712146C	DLLA150S 881	0433 271 821				4x0,36x150°	Nozzle
712147C	DLLA150S 883	0433 271 820				5x0,39x150°	Nozzle
712152CL	DLLA148S 885	0433 271 819				4x0,36x148°	Nozzle
712153CL	DLLA145S 886	0433 271 818				4x0,34x145°	Nozzle
712154C	DLLA144S 889	0433 271 817				4x0,30x144°	Nozzle
712161C	DLLA146S 890	0433 271 816				4x0,34x146°	Nozzle
71217	DLLA150S 891	0433 271 440				3x0,31x150°	Nozzle
712171	DLLA28S 892	0433 271 442				1x0,60x28°	Nozzle
712171C	DLLA155S 895	0433 271 815				6x0,29x155°	Nozzle
71219C	DLLA150S 896	0433 271 814				5x0,32x150°	Nozzle
71300C	DLLA142S 897	0433 271 813				4x0,30x142°	Nozzle
71301C	DLLA150S 898	9430 084 212				4x0,31x150°	Nozzle
713021	DLLA32S 900	0433 271 445				1x0,54x32°	Nozzle
713023	DLLA150S 902	0433 271 446				4x0,36x150°	Nozzle
71303C	DLLA150S 903	0433 271 811				4x0,30x150°	Nozzle
713041C	DLLA150S 904	0433 271 810				4x0,44x150°	Nozzle
71305C	DLLA160S 908	0433 271 809				4x0,30x160°	Nozzle
713062	DLLA148S 909	0433 271 448				4x0,32x148°	Nozzle
713071	DLLA31S 915	0433 271 452				1x0,68x31°	Nozzle
713071C	DLLA150S 916	0433 271 807				5x0,34x150°	Nozzle
713072C	DLLA158S 920	0433 271 806				4x0,28x158°	Nozzle
713073	DLLA31S 921	0433 271 454				1x0,56x31°	Nozzle
713074C	DLLA142S 924	0433 271 805				4x0,43x142°	Nozzle
713075C	DLLA150S 925	0433 271 804				4x0,28x150°	Nozzle
713076	DLLA142S 926	0433 271 466				4x0,35x142°	Nozzle
713079	DLLA30S 931	0433 271 461				1x0,62x30°	Nozzle
713080	DLLA150S 935	0433 271 462				4x0,39x150°	Nozzle
713081C	DLLA136S 943	0433 271 740				4x0,41x136°	Nozzle
713082C	DLLA142S 947	0433 271 800				4x0,37x142°	Nozzle
713083	DLLA142S 953	9430 084 222				4x0,35x142°	Nozzle
713083C	DLLA154S 970	0433 271 791				4x0,38x154°	Nozzle
713084C	DLLA151S 972	0433 271 790				4x0,33x151°	Nozzle
713085C	DLLA150S 974	0433 271 789				4x0,285x150°	Nozzle
71309	DLLA150S 975	0433 271 465				4x0,42x150°	Nozzle

<i>Our Ref.</i>	<i>Stamping</i>	<i>Part Number</i>	<i>CP</i>	<i>DLC</i>	<i>D/A</i>	<i>Technical Data</i>	<i>Description</i>
71310C	DLLA140S 976	0433 271 788				4x0,46x140°	Nozzle
713112C	DLLA150S 977	0433 271 787				4x0,28x150°	Nozzle
713117C	DLLA142S 980	0433 271 785				4x0,32x142°	Nozzle
713118C	DLLA132S 981	0433 271 784				4x0,34x132°	Nozzle
713119	DLLA144S 982	0433 271 467				4x0,30x144°	Nozzle
71312C	DLLA138S 983	0433 271 783				4x0,35x138°	Nozzle
71313C	DLLA151S 985	0433 271 782				4x0,30x151°	Nozzle
713151	DLLA151S 991	9430 084 226				4x0,27x151°	Nozzle
71316C	DLLA144S 992	0433 271 781				5x0,35x144°	Nozzle
71317C	DLLA150S 993	0433 271 780				4x0,24x150°	Nozzle
71317CL	DLLA160S 995	0433 271 778				4x0,29x160°	Nozzle
71318	DLLA134S 999	0433 271 471				4x0,38x134°	Nozzle
71318C	DLLA134S999 D5	0433 271 471				4x0,38x134°	Nozzle
71319	DLLA134S 999+/-	0433 271 589				4x0,38x134°	Nozzle
71320C	DLLA136S 1000	0433 271 775				3x0,36x136°	Nozzle
71321C	DLLA124S 1001	0433 271 774				4x0,31x124°	Nozzle
71323	DLLA140S 1003	0433 271 478				4x0,35x140°	Nozzle
713242C	DLLA160S 1012	0433 271 770				4x0,27x160°	Nozzle
713243	DLLA142S 1013	9430 084 227				4x0,33x142°	Nozzle
713245L	DLLA140S 1017	0433 271 480				3x0,45x140°	Nozzle
713246	DLLA145S 1018	0433 271 481				8x0,25x145°	Nozzle
713247	DLLA145S 1019	0433 271 482				8x0,28x145°	Nozzle
71325C	DLLA136S 1020	0433 271 768				3x0,39x136°	Nozzle
71327CL	DLLA145S 1023	0433 271 765				4x0,33x145°	Nozzle
71329C	DLLA150S 1029	0433 271 764				5x0,27x150°	Nozzle
71330C	DLLA160S 1030	0433 271 763				4x0,26x160°	Nozzle
71331C	DLLA155S 1032	0433 271 761				5x0,23x155°	Nozzle
71332	DLLA136S 1034	0433 271 487				4x0,36x136°	Nozzle
71333	DLLA144S 1037	0433 271 489				4x0,37x144°	Nozzle
713341C	DLLA140S 1039	0433 271 759				4x0,32x140°	Nozzle
713343	DLLA136S 1043	0433 271 495				4x0,38x136°	Nozzle
713344C	DLLA150S 1044	0433 271 758				5x0,35x150°	Nozzle
71335	DLLA150S 1052	0433 271 494				4x0,28x150°	Nozzle
713351C	DLLA140S 1054	0433 271 756				5x0,41x140°	Nozzle
713353C	DLLA150S 1055	0433 271 755				4x0,32x150°	Nozzle
713356C	DLLA148S 1058	0433 271 754				4x0,37x148°	Nozzle
713357C	DLLA145S 1059	0433 271 753				5x0,36x145°	Nozzle
71336C	DLLA150S 1066	0433 271 746				3x0,34x150°	Nozzle
71337C	DLLA150S 1067	0433 271 745				4x0,28x150°	Nozzle
713380C	DLLA140S 1075	0433 271 741				4x0,47x140°	Nozzle
713382C	DLLA159S 1082	0433 271 738				4x0,25x159°	Nozzle
713384C	DLLA160S 1084	0433 271 736				4x0,27x160°	Nozzle
713386C	DLLA154S 1086	0433 271 735				5x0,35x154°	Nozzle
7133872C	DLLA150S 1087	0433 271 734				4x0,32x150°	Nozzle
7133874C	DLLA148S 1089	0433 271 732				5x0,30x148°	Nozzle
713387C	DLLA150S 1091	0433 271 731				5x0,27x150°	Nozzle
71339	DLLA136S 1094	0433 271 499				4x0,37x136°	Nozzle
71340	DLLA142S 1096	0433 271 502				4x0,31x142°	Nozzle
71341C	DLLA145S 1097	0433 271 729				5x0,34x145°	Nozzle
71342C	DLLA148S 1098	0433 271 728				4x0,30x148°	Nozzle
71343C	DLLA140S 1109	0433 271 722				4x0,33x140°	Nozzle
713442C	DLLA138S 1112	0433 271 720				3x0,34x138°	Nozzle
713443C	DLLA134S 1113	0433 271 719				4x0,30x134°	Nozzle
71345C	DLLA140S 1116	0433 271 718				5x0,36x140°	Nozzle

<i>Our Ref.</i>	<i>Stamping</i>	<i>Part Number</i>	<i>CP</i>	<i>DLC</i>	<i>D/A</i>	<i>Technical Data</i>	<i>Description</i>
Bosch							
713461C	DLLA140S 1117	0433 271 717				5x0,36x140°	Nozzle
713462	DLLA134S 1119	0433 271 503				4x0,37x134°	Nozzle
713463C	DLLA140S 1121	0433 271 716				4x0,31x140°	Nozzle
713467	DLLA131S 1131	0433 271 507				4x0,41x131°	Nozzle
71347C	DLLA150S 1137	0433 271 714				8x0,33x150°	Nozzle
713482	DLLA142S 1142	9430 034 284				4x0,28x142°	Nozzle
71350	DLLA137S 1157	0433 271 515				5x0,30x137°	Nozzle
71350C	DLLA150S 1158	0433 271 704				4x0,30x150°	Nozzle
713522C	DLLA145S 1160	0433 271 703				5x0,39x145°	Nozzle
713523C	DLLA145S 1161	0433 271 702				5x0,36x145°	Nozzle
713524C	DLLA144S 1162	9430 084 241				4x0,30x144°	Nozzle
71353C	DLLA145S 1169	0433 271 698				6x0,32x145°	Nozzle
713543	DLLA142S 1173	0433 271 518				5x0,29x142°	Nozzle
713544C	DLLA137S 1174	0433 271 695				5x0,26x137°	Nozzle
713545C	DLLA146S 1175	0433 271 694				4x0,33x146°	Nozzle
713549C	DLLA152S 1180	0433 271 691				5x0,28x152°	Nozzle
713550C	DLLA160S 1181	0433 271 690				4x0,24x160°	Nozzle
713552C	DLLA152S 1184	0433 271 688				5x0,26x152°	Nozzle
713553C	DLLA142S 1189	0433 271 684				4x0,34x142°	Nozzle
713554	DLLA35S 1190	0433 271 520				1x0,50x35°	Nozzle
713555	DLLA138S 1191	0433 271 521				5x0,32x138°	Nozzle
713556	DLLA138S 1191+/ 713557	0433 271 587				5x0,31x138°	Nozzle
713557	DLLA134S 1199	0433 271 524				5x0,33x134°	Nozzle
7135572	DLLA134S 1199+/ 71356	0433 271 588				5x0,33x134°	Nozzle
71356	DLLA151S 1200	9430 084 243				4x0,28x151°	Nozzle
713561C	DLLA134S 1201	0433 271 680				4x0,30x134°	Nozzle
713563C	DLLA148S 1204	0433 271 678				7x0,30x148°	Nozzle
7135640C	DLLA145S 1206	0433 271 676				5x0,35x145°	Nozzle
7135641C	DLLA149S 1207	0433 271 675				5x0,32x149°	Nozzle
713564C	DLLA137S 1208	0433 271 674				5x0,28x137°	Nozzle
7135651C	DLLA149S 1209	0433 271 673				5x0,36x149°	Nozzle
7135654C	DLLA155S 1215	0433 271 670				5x0,34x155°	Nozzle
713565C	DLLA140S 1217	0433 271 668				6x0,27x140°	Nozzle
7135661C	DLLA150S 1220	0433 271 666				6x0,31x150°	Nozzle
713566C	DLLA155S 1221	0433 271 665				6x0,30x155°	Nozzle
713567	DLLA142S 1224	0433 271 527				6x0,29x142°	Nozzle
7135672C	DLLA149S 1225	0433 271 664				5x0,31x149°	Nozzle
7135675L	DLLA139S 1235	0433 271 529				4x0,43x139°	Nozzle
713568C	DLLA150S 1237	0433 271 656				6x0,32x150°	Nozzle
713569C	DLLA150S 1238	0433 271 655				6x0,32x150°	Nozzle
71357C	DLLA146S 1245	0433 271 652				6x0,32x146°	Nozzle
71358C	DLLA140S 1252	0433 271 646				6x0,33x140°	Nozzle
71359C	DLLA130S 1253	9430 084 244				5x0,36x130°	Nozzle
713602	DLLA142S 1257	0433 271 534				5x0,30x142°	Nozzle
71360C	DLLA144S 1262	0433 271 645				4x0,32x144°	Nozzle
71361C	DLLA148S 1263	0433 271 644				7x0,29x148°	Nozzle
71362	DLLA142S 1264	9430 084 245				4x0,32x142°	Nozzle
71364	DLLA142S 1266	9430 084 247				4x0,34x142°	Nozzle
713642C	DLLA148S 1272	0433 271 638				7x0,29x148°	Nozzle
7136433C	DLLA137S 1273					5x0,28x137°	Nozzle
7136439C	DLLA152S 1277	0433 271 635				8x0,25x152°	Nozzle
713644C	DLLA125S 1278	0433 271 634				6x0,28x125°	Nozzle
713645C	DLLA152S 1280	0433 271 632				8x0,26x152°	Nozzle
713646	DLLA134S 1284+/ 10	0433 271 590				5x0,34x134°	Nozzle

<i>Our Ref.</i>	<i>Stamping</i>	<i>Part Number</i>	<i>CP</i>	<i>DLC</i>	<i>D/A</i>	<i>Technical Data</i>	<i>Description</i>
713646C	DLLA143S 1292	0433 271 626				6x0,33x143°	Nozzle
713648C	DLLA150S 1295	0433 271 625				6x0,31x150°	Nozzle
713650C	DLLA148S 1298	0433 271 624				7x0,34x148°	Nozzle
713654C	DLLA143S 1302	0433 271 616				6x0,31x143°	Nozzle
7136559C	DLLA135S 1309	0433 271 602				6x0,26x135°	Nozzle
713655C	DLLA160S 1305	0433 271 614				5x0,33x160°	Nozzle
7136560C	DLLA146S 1310	0433 271 601				7x0,29x146°	Nozzle
7136561C	DLLA132S 1320	0433 272 997				5x0,23x132°	Nozzle
7136562C	DLLA150S 1322	0433 272 995				4x0,33x150°	Nozzle
713656C	DLLA155S 1323	0433 272 994				4x0,30x155°	Nozzle
713657C	DLLA132S 1335	0433 272 987				5x0,20x132°	Nozzle
713658C	DLLA132S 1384	0433 272 963				6x0,19x132°	Nozzle
71366	DLLA150S 1600	0433 271 040				5x0,25x150°	Nozzle
71367	DLLA150S 2120	0433 271 268				4x0,35x150°	Nozzle
71368	DLLA35S 2180	0433 271 078				1x0.70x35°	Nozzle
71369	DLLA144S 8200	0433 271 447				4x0,35x144°	Nozzle
71404L	DLLB160S 544	0433 271 255				4x0,28x160°	Nozzle
714053	DLLB155S 580	0433 271 278				5x0,31x155°	Nozzle
714058	DLLB155S 598	0433 271 291				4x0,41x155°	Nozzle
714075	DLLB155S 675	0433 271 332				4x0,38x155°	Nozzle
714078	DLLB150S 688	0433 271 340				4x0,36x150°	Nozzle
71412	DLLB150S 711	0433 271 346				4x0,38x150°	Nozzle
71415	DLLB150S 765	0433 271 347				4x0,37x150°	Nozzle
714166	DLLB150S 794	0433 271 400				4x0,29x150°	Nozzle
714171C	DLLB150S 821	0433 271 846				4x0,30x150°	Nozzle
714178C	DLLB151S 854	0433 271 828				4x0,34x151°	Nozzle
71420C	DLLB151S 907	9430 084 214				4x0,30x151°	Nozzle
71430	DLLB150S 1049	9430 084 230				4x0,33x150°	Nozzle
71454	DLLC150S 624	0433 271 999				4x0,44x150°	Nozzle
71457	DLLC150S 646	0433 271 316				8x0,24x150°	Nozzle
71460	DLLC150S 660	0433 271 323				8x0,25x150°	Nozzle
71470	DLLZ156S 948	0433 271 460				4x0,28+5x0.30	Nozzle
71473	DLLZ156S 1048	0433 271 492				4x0,23+5x0.27	Nozzle
71474C	DLLZ155S 1133	0433 271 715				7x0,39x155°	Nozzle
71475C	DLLZ152S 1229	0433 271 660				5x0,55x152°	Nozzle
71479C	DLLZ152S 1247	0433 271 650				5x0,58x152°	Nozzle
71501	DLLA150P 1	0433 171 001				4x0,24x150°	Nozzle
71503	DLLA150P 3	0433 171 003				3x0,30x150°	Nozzle
71505	DLLA155P 5	0433 171 006				5x0,34x155°	Nozzle
71509	DLLA160P 9	0433 171 010				5x0,33x160°	Nozzle
71511	DLLA150P 11	0433 171 012	CP			4x0,21x150°	Nozzle
71520	DLLA150P 20	0433 171 021				4x0,36x150°	Nozzle
71522	DLLA150P 22	0433 171 023				4x0,33x150°	Nozzle
71524	DLLA150P 24	0433 171 025				4x0,31x150°	Nozzle
71529	DLLA150P 29	0433 171 030				5x0,30x150°	Nozzle
71530	DLLA150P 30	0433 171 031				4x0,29x150°	Nozzle
71531	DLLA150P 31	0433 171 032				5x0,37x150°	Nozzle
71535	DLLA160P 35	0433 171 036				5x0,32x160°	Nozzle
71536	DLLA150P 36	0433 171 037				4x0,39x150°	Nozzle
71538	DLLA148P 38	0433 171 039				4x0,30x148°	Nozzle
71539	DLLA150P 39	0433 171 040				4x0,37x150°	Nozzle
71540	DLLA143P 40	0433 171 041				4x0,36x143°	Nozzle
71542	DLLA150P 42	0433 171 042				4x0,30x150°	Nozzle
71543	DLLA150P 43	0433 171 043				4x0,42x150°	Nozzle

<i>Our Ref.</i>	<i>Stamping</i>	<i>Part Number</i>	<i>CP</i>	<i>DLC</i>	<i>D/A</i>	<i>Technical Data</i>	<i>Description</i>
71544	DLLA140P 44	0433 171 044				4x0,30x140°	Nozzle
71548	DLLA150P 48	0433 171 997				5x0,28x150°	Nozzle
71549	DLLA150P 49	0433 171 049				5x0,32x150°	Nozzle
71552	DLLA150P 52	0433 171 052				4x0,39x150°	Nozzle
71553	DLLA150P 53	0433 171 053				4x0,30x150°	Nozzle
71559	DLLA150P 59	0433 171 059				4x0,38x150°	Nozzle
71561	DLLA150P 61	0433 171 061				4x0,28x150°	Nozzle
71563	DLLA160P 63	0433 171 063				5x0,34x160°	Nozzle
71564	DLLA150P 64	0433 171 064				4x0,38x150°	Nozzle
71566	DLLA155P 66	0433 171 066				4x0,30x155°	Nozzle
71567	DLLA155P 67	0433 171 067				4x0,28x155°	Nozzle
71569	DLLA136P 69	0433 171 069				3x0,38x136°	Nozzle
71571	DLLA150P 71	0433 171 071				4x0,24x150°	Nozzle
71574	DLLA155P 74	0433 171 074				4x0,29x155°	Nozzle
71576	DLLA150P 76	0433 171 076				4x0,42x150°	Nozzle
71585	DLLA160P 85	0433 171 082				4x0,29x160°	Nozzle
71587	DLLA142P 87	0433 171 084				5x0,32x142°	Nozzle
715908	DLLA150P 91/	0433 171 117				5x0,38x150°	Nozzle
71591	DLLA150P 91/+	0433 171 164				5x0,37x150°	Nozzle
71593	DLLA143P 93	0433 171 089				5x0,30x143°	Nozzle
71596	DLLA143P 96	0433 171 092				4x0,33x143°	Nozzle
71597	DLLA148P 97	0433 171 093				4x0,32x148°	Nozzle
71599	DLLA150P 99	0433 171 095				5x0,34x150°	Nozzle
71600	DLLA150P 100	9430 084 702				5x0,28x150°	Nozzle
71606	DLLA150P 106	9430 084 703				5x0,29x150°	Nozzle
71610	DLLA150P 110	0433 171 100				4x0,37x150°	Nozzle
71612	DLLA150P 112	9430 084 708				4x0,36x150°	Nozzle
71613	DLLA150P 113	0433 171 102				4x0,30x150°	Nozzle
71614	DLLA155P 114	0433 171 103				4x0,32x155°	Nozzle
71615	DLLA150P 115	0433 171 104				4x0,32x150°	Nozzle
71618	DLLA144P 118	0433 171 107				4x0,32x144°	Nozzle
71619	DLLA150P 119	0433 171 108				5x0,40x150°	Nozzle
71622	DLLA143P 122	0433 171 111				4x0,34x143°	Nozzle
71623	DLLA143P 123	0433 171 112				4x0,38x143°	Nozzle
71625	DLLA155P 125	0433 171 113				4x0,29x155°	Nozzle
716291	DLLA150P 129/	9430 084 711				5x0,33x150°	Nozzle
71630	DLLA150P 130	0433 171 118				4x0,34x150°	Nozzle
71631	DLLA150P 131	0433 171 119				4x0,30x150°	Nozzle
71633	DLLA150P 133	0433 171 121				4x0,34x150°	Nozzle
71635	DLLA155P 135	0433 171 123				4x0,35x155°	Nozzle
71639	DLLA146P 139	0433 171 127				4x0,39x146°	Nozzle
71640	DLLA146P 140	0433 171 128				4x0,44x146°	Nozzle
71644	DLLA144P 144	0433 171 130				5x0,36x144°	Nozzle
71645	DLLA150P 145	0433 171 131				4x0,33x150°	Nozzle
71649	DLLA148P 149	0433 171 134				5x0,33x148°	Nozzle
71653	DLLA155P 153	9430 084 714				4x0,29x155°	Nozzle
716542	DLLA146P 154-	0433 171 165				5x0,38x146°	Nozzle
71655	DLLA150P 155	9430 084 715				4x0,36x150°	Nozzle
71657	DLLA155P 157	0433 171 140				4x0,31x155°	Nozzle
71660	DLLA143P 160	0433 171 143				4x0,34x143°	Nozzle
71661	DLLA158P 161	0433 171 144				7x0,24x158°	Nozzle
71663	DLLA148P 163	0433 171 146				4x0,32x148°	Nozzle
71664	DLLA148P 164	0433 171 147				4x0,31x148°	Nozzle
71666	DLLA146P 166	0433 171 149				4x0,41x146°	Nozzle

<i>Our Ref.</i>	<i>Stamping</i>	<i>Part Number</i>	<i>CP</i>	<i>DLC</i>	<i>D/A</i>	<i>Technical Data</i>	<i>Description</i>
716662	DLLA146P 166/	0433 171 214				4x0,40x146°	Nozzle
71667	DLLA150P 167	0433 171 150				5x0,295x150°	Nozzle
71668	DLLA158P 168	0433 171 151				7x0,26x158°	Nozzle
71671	DLLA160P 171	0433 171 153				5x0,29x160°	Nozzle
716741	DLLA150P 174/	9430 084 717				5x0,28x150°	Nozzle
71675	DLLA140P 175	0433 171 154				4x0,29x140°	Nozzle
71677	DLLA150P 177	0433 171 156				5x0,36x150°	Nozzle
71678	DLLA150P 178	0433 171 157				5x0,32x150°	Nozzle
71679	DLLA155P 179	0433 171 158				6x0,24x155°	Nozzle
716791	DLLA155P 179	F019 121 179				7x0,235x155°	Nozzle
71680	DLLA134P 180	0433 171 159				4x0,29x134°	Nozzle
716801	DLLA155P 180	F019 121 180				7x0,245x155°	Nozzle
71683	DLLA150P 183	9430 084 718				5x0,30x150°	Nozzle
71684	DLLA144P 184	0433 171 161				4x0,39x144°	Nozzle
716842	DLLA144P 184/	0433 171 174				4x0,40x144°	Nozzle
71686	DLLA134P 186	0433 171 162				5x0,37x134°	Nozzle
71699	DLLA150P 199	0433 171 168				5x0,35x150°	Nozzle
71703	DLLA146P 203	0433 171 169				5x0,40x146°	Nozzle
71705	DLLA150P 205	0433 171 171				4x0,30x150°	Nozzle
71706	DLLA154P 206	0433 171 172				4x0,25x154°	Nozzle
71709	DLLA160P 209	0433 171 173				3+3x0,27x160°	Nozzle
71712	DLLA150P 212					4x0,24x150°	Nozzle
71717	DLLA155P 217	F019 121 217				7x0,245x155°	Nozzle
71721	DLLA142P 221	0433 171 180				5x0,32x142°	Nozzle
71724	DLLA146P 224	0433 171 182				5x0,32x146°	Nozzle
71728	DLLA150P 228	0433 171 186				4x0,28x150°	Nozzle
71729	DLLA148P 229	0433 171 187				6x0,24x148°	Nozzle
71730	DLLA155P 230	0433 171 188	CP			8x0,26x155°	Nozzle
71732	DLLA150P 232	0433 171 190				4x0,30x150°	Nozzle
71735	DLLA150P 235	0433 171 193				5x0,28x150°	Nozzle
71741	DLLA148P 241	0433 171 195				5x0,32x148°	Nozzle
71750	DLLA135P 250	0433 171 200				5x0,30x135°	Nozzle
71770	DLLA155P 270	0433 171 204				5x0,29x155°	Nozzle
71771	DLLA140P 271	9430 084 731				6x0,21x140°	Nozzle
71773	DLLA155P 273	0433 171 205				4x0,28x155°	Nozzle
71774	DLLA155P 274	0433 171 206				4x0,31x155°	Nozzle
71777	DLLA155P 277	0433 171 208				4x0,34x155°	Nozzle
71782	DLLA155P 282	9430 084 734				5x0,33x155°	Nozzle
71785	DLLA152P 285	0433 171 210				6x0,28x152°	Nozzle
71786	DLLA145P 286	0433 171 211				6x0,23x145°	Nozzle
71796	DLLA134P 296	0433 171 215				6x0,26x134°	Nozzle
71799	DLLA150P 299	0433 171 216				4x0,29x150°	Nozzle
71805	DLLA140P 305	0433 171 220				4x0,35x140°	Nozzle
71806	DLLA155P 306	0433 171 221	CP			8x0,24x155°	Nozzle
71807	DLLA155P 307	0433 171 222				8x0,26x155°	Nozzle
71809	DLLA145P 309	9430 084 732				5x0,27x145°	Nozzle
71810	DLLA145P 310	9430 084 733				5x0,27x145°	Nozzle
71812	DLLA142P 312	0433 171 223				5x0,35x142°	Nozzle
71813	DLLA152P 313	0433 171 224				6x0,26x152°	Nozzle
71815	DLLA150P 315	0433 171 225				5x0,26x150°	Nozzle
71816	DLLA154P 316	0433 171 226				4x0,25x154°	Nozzle
71826	DLLA150P 326	0433 171 231				5x0,27x150°	Nozzle
71828	DLLA145P 328	0433 171 232	CP			6x0,23x145°	Nozzle
71829	DLLA148P 329	0433 171 233				7x0,25x148°	Nozzle

Our Ref.	Stamping	Part Number	CP	DLC	D/A	Technical Data	Description
71832	DLLA154P 332	9430 084 742				5x0,28x154°	Nozzle
71835	DLLA152P 335	0433 171 237				6x0,27x152°	Nozzle
71839	DLLA152P 339	0433 171 241				6x0,295x152°	Nozzle
71845	DLLA150P 345	0433 171 246				4x0,28x150°	Nozzle
71853	DLLA144P 353	0433 171 252				5x0,23x144°	Nozzle
71854	DLLA144P 354	0433 171 251				5x0,23x144°	Nozzle
71855	DLLA153P 355	0433 171 253				5x0,33x153°	Nozzle
71860	DLLA147P 360	0433 171 257				5x0,22x147°	Nozzle
71869	DLLA149P 369	0433 171 262				5x0,32x149°	Nozzle
71870	DLLA147P 370	0433 171 263				5x0,22x147°	Nozzle
71871	DLLA134P 371	0433 171 264				6x0,28x134°	Nozzle
71872	DLLA134P 372	0433 171 265				6x0,25x134°	Nozzle
71873	DLLA135P 373	0433 171 266				5x0,27x135°	Nozzle
71874	DLLA152P 378	0433 171 268				5x0,27x152°	Nozzle
71875	DLLA145P 392	0433 171 280				5x0,33x145°	Nozzle
718754	DLLA145P 394	0433 171 281				5x0,26x145°	Nozzle
718758	DLLA138P 401	0433 171 285				5x0,28x138°	Nozzle
71876	DLLA138P 403	0433 171 287				5x0,33x138°	Nozzle
718761	DLLA142P 406	0433 171 289				6x0,26x142°	Nozzle 2 springs
718762	DLLA148P 408	0433 171 291				7x0,24x148°	Nozzle
718763	DLLA142P 418	0433 171 298				6x0,25x142°	Nozzle
7187631	DLLA142P 419	0433 171 299				6x0,24X142°	Nozzle
718764	DLLA134P 422	0433 171 303				5x0,28x134°	Nozzle
718766	DLLA134P 423	0433 171 304	CP			6x0,19x134°	Nozzle
71877	DLLA134P 424	0433 171 305	CP			6x0,185x134°	Nozzle
718773	DLLA168P 426	0433 171 306				8x0,24x168°	Nozzle
71878	DLLA134P 430	0433 171 309				5x0,28x134°	Nozzle
718782	DLLA134P 431	0433 171 310				5x0,255x134°	Nozzle
718786	DLLA145P 438	0433 171 316				6x0,215x145°	Nozzle
71879	DLLA144P 449	0433 171 323				4x0,33x144°	Nozzle
71880	DLLA144P 450	0433 171 324				4x0,36x144°	Nozzle
71882	DLLA152P 452	0433 171 326				8x0,28x152°	Nozzle
718821	DLLA145P 466	0433 171 335				6x0,21x145°	Nozzle
718822	DLLA160P 469	0433 171 338				4x0,21x160°	Nozzle
7188224	DLLA150P 476+	0433 171 343				6x0,23x150°	Nozzle
7188226	DLLA152P 486/	0433 171 350				6x0,34x152°	Nozzle
718823	DLLA143P 495	0433 171 357				4x0,36x143°	Nozzle
718824	DLLA146P 499	0433 171 360				5x0,34x146°	Nozzle
718825	DLLA145P 504	0433 171 363				6x0,22x145°	Nozzle
7188250	DLLA144P 510	0433 171 366				5x0,27X144	Nozzle
71882502	DLLA148P 513	0433 171 369				6x0,26x148°	Nozzle
71882503	DLLA149P 514	0433 171 370	CP			6x0,225x149°	Nozzle
71882505	DLLA148P 522	0433 171 386				7x0,24x148°	Nozzle
71882506	DLLA144P 521	0433 171 385				5x0,23x144°	Nozzle
71882507	DLLA150P 524	0433 171 387				5x0,23x144°	Nozzle
7188251	DLLA144P 527	0433 171 390	CP			5x0,21x144°	Nozzle
718826	DLLA149P 528	0433 171 391				6x0,24x149°	Nozzle
718828	DLLA152P 531	0433 171 394				7x0,27x152°	Nozzle
71883	DLLA147P 538	0433 171 398	CP			8x0,22x147°	Nozzle
718835	DLLA150P 545/	0433 171 403				8x0,31x150°	Nozzle
71885	DLLA137P 553	9430 084 749				5x0,26x137°	Nozzle
718853	DLLA155P 556	0433 171 408				7x0,235x155°	Nozzle
71886	DLLA155P 564	0433 171 413				5x0,30x155°	Nozzle
718866	DLLA155P 570	0433 171 431				5x0,31x155°	Nozzle

Our Ref.	Stamping	Part Number	CP	DLC	D/A	Technical Data	Description
718868	DLLA152P 571	0433 171 432				6x0,245x152°	Nozzle
71887	DLLA155P 572/	0433 171 433	CP			8x0,20x155°	Nozzle UIS
718872	DLLA155P 572/+		CP			8x0,19x155°	Nozzle UIS
718873	DLLA150P 573	0433 171 434	CP			8x0,22x150°	Nozzle
718874	DLLA145P 574	0433 171 435				5x0,26x145°	Nozzle
71888	DLLA160P 577	0433 171 436	CP			8x0,20x160°	Nozzle
718881	DLLA155P 579+	0433 171 438	CP			8x0,25x155°	Nozzle
718882	DLLA145P 580/	0433 171 439				6x0,24x145°	Nozzle UIS
718883	DLLA146P 581	0433 171 440				6x0,30x146°	Nozzle
718885	DLLA150P 585	0433 171 444				5x0,28x150°	Nozzle
718888	DLLA145P 593	0433 171 448	CP			8x0,21x145°	Nozzle 2 springs
718891	DLLA154P 596+	0433 171 450	CP			8x0,20x154°	Nozzle
718892	DLLA154P 596++	0433 171 450	CP			8x0,20x154°	Nozzle
71890	DLLA146P 600	9430 084 757				6x0,32x146°	Nozzle
718901	DLLA149P 601	0433 171 451	CP			8x0,23x149°	Nozzle 2 springs
7189023	DLLA145P 605	0433 171 453				5x0,24x145°	Nozzle
7189024	DLLA145P 606	0433 171 454				5x0,27x145°	Nozzle
7189027	DLLA145P 609	0433 171 456	CP			8x0,19x145°	Nozzle 2 springs
718903	DLLA148P 610	0433 171 457				7x0,25x148°	Nozzle
7189031	DLLA148P 611	0433 171 458				7x0,225x148°	Nozzle
718904	DLLA145P 618	9430 084 759				5x0,26x145°	Nozzle
718905	DLLA145P 627	0433 171 466	CP			8x0,185x145°	Nozzle 2 springs
718906	DLLA140P 629	0433 171 467				5x0,28x140°	Nozzle
7189062	DLLA145P 632	0433 171 468				6x0,245x145°	Nozzle
718907	DLLA160P 634	0433 171 469	CP			4x0,165x160°	Nozzle
71891	DLLA150P 635	0433 171 470	CP			8x0,20x150°	Nozzle UIS
718914	DLLA159P 638	0433 171 473	CP			8x0,16x159°	Nozzle 2 springs
71892	DLLA155P 657	0433 171 465	CP			8x0,24x155°	Nozzle
718922	DLLA147P 658	0433 171 478	CP			5x0,25x147°	Nozzle
718924	DLLA152P 660	0433 171 480				5x0,30x152°	Nozzle
718928	DLLA158P 678	0433 171 493	CP			8x0,22x156°	Nozzle
71893	DLLA147P 680	0433 171 495				5x0,28x147°	Nozzle
71894	DLLA148P 694	0433 171 509				5x0,30x148°	Nozzle
718942	DLLA146P 708	0433 171 519				5x0,38x146°	Nozzle
718943	DLLA154P 709+	0433 171 520	CP			8x0,20x154°	Nozzle
718945	DLLA150P 711	0433 171 521				6x0,31x150°	Nozzle
718946	DLLA142P 731	F000 430 300				5x0,35x142°	Nozzle
718948	DLLA145P 748	0433 171 536	CP			6x0,16x145°	Nozzle 2 springs
718955	DLLA155P 765	0433 171 545	CP			6x0,21x155°	Nozzle UIS
718957	DLLA145P 785/	0433 171 550				6x0,29x145°	Nozzle
718958	DLLA147P 799	0433 171 555				8x0,25x147°	Nozzle
718959	DLLA153P 810	0433 171 557	CP			8x0,13x153°	Nozzle
718961	DLLA156P 819	0433 171 561	CP			8x0,16x156°	Nozzle
718962	DLLA155P 822	0433 171 562	CP	DLC		8x0,205x155°	Nozzle CR
718963	DLLA140P 826	0433 171 564	CP			8x0,22x140°	Nozzle UIS
718965	DLLA148P 836	0433 171 570	CP			6x0,18x148°	Nozzle
718967	DLLA150P 847	0433 171 575	CP			8x0,21x150°	Nozzle UIS
718968	DLLA150P 848	0433 171 576	CP			8x0,20x150°	Nozzle UIS
7189682	DLLA156P 850	0433 171 578	CP			8x0,16x156°	Nozzle
7189686	DLLA147P 854	0433 171 579				5x0,27x147°	Nozzle
7189688	DLLA154P 866	0433 171 583	CP			7x0,25x154°	Nozzle
718969	DLLA155P 872	0433 171 584	CP			6x0,23x155°	Nozzle UIS
7189691	DLLA155P 872+		CP			6x0,265x155°	Nozzle UIS
7189693	DLLA147P 875	0433 171 585				5x0,245x147°	Nozzle

Our Ref.	Stamping	Part Number	CP	DLC	D/A	Technical Data	Description
718970	DLLA156P 889/	0433 171 594	CP	DLC		6x0,17x156°	Nozzle CR
718971	DLLA143P 894/	0433 171 596	CP			8x0,195x143°	Nozzle UIS
718972	DLLA152P 903	0433 171 600	CP			5x0,24x152°	Nozzle UIS
718973	DLLA150P 913	0433 171 607				6x0,227x150°	Nozzle
718974	DLLA145P 926	0433 171 616	CP	DLC		5x0,175x145°	Nozzle CR
718975	DLLA145P 926+		CP			5x0,175x145°	Nozzle CR
718986	DLLA151P 941	0433 171 624				6x0,235x151°	Nozzle
718987	DLLA150P 943+	0433 171 628	CP			6x0,235x150°	Nozzle
718988	DLLA140P 947	0433 171 631	CP			8x0,225x140°	Nozzle UIS
71900	DLLA150P 957	0433 171 634	CP			8x0,195x150°	Nozzle
719003	DLLA156P 963+	0433 171 637	CP			8x0,17x156°	Nozzle
7190035	DLLA152P 967	0433 171 640	CP			7x0,225x152°	Nozzle
7190037	DLLA148P 1010	0433 171 653	CP			6x0,20x148°	Nozzle
7190038	DLLA150P 1011/	0433 171 654	CP			5x0,165x150°	Nozzle CR
719005	DLLA160P 1032+	0433 171 676	CP			8x0,20x160°	Nozzle
7190069	DLLA144P 1050	0433 171 681	CP	DLC		6x0,18x144°	Nozzle CR
719007	DLLA140P 1051	0433 171 682	CP	DLC		6x0,16x140°	Nozzle CR
719008	DLLA150P 1053	0433 171 684	CP			7x0,19x150°	Nozzle
719009	DLLA150P 1054	0433 171 685	CP			7x0,19x150°	Nozzle
7190093	DLLA156P 1059	0433 171 688	CP			8x0,155x156°	Nozzle
7190098	DLLA160P 1063+	0433 171 690	CP			6x0,16x160°	Nozzle CR
719010	DLLA148P 1067	0433 171 693	CP			6x0,18x148°	Nozzle CR
719011	DLLA150P 1076	0433 171 699	CP	DLC		8x0,205x150°	Nozzle CR
719014	DLLA156P 1107	0433 171 712	CP			6x0,165x156°	Nozzle CR
719016	DLLA156P 1114	0433 171 719	CP			6x0,19x156°	Nozzle CR
7190165	DLLA147P 1121+	0433 171 362				7x0,265x147°	Nozzle
719017	DLLA150P 1151	0433 171 736	CP			8x0,22x150°	Nozzle
7190171	DLLA150P 1151		CP	DLC			Nozzle
7190177	DLLA150P 1163+	0433 171 740	CP			6x0,24x150°	Nozzle
7190178	DLLA150P 1164+	0433 171 741	CP			6x0,235x150°	Nozzle
719018	DLLA151P 1169	0433 171 743	CP			6x0,21x151°	Nozzle
719019	DLLA144P 1170	0433 171 744	CP			7x0,19x144°	Nozzle
719021	DLLA150P 1197/	0433 171 755	CP	DLC		6x0,16x150°	Nozzle CR
719023	DLLA166P 1217	0433 171 767	CP			8x0,24x166°	Nozzle
719024	DLLA148P 1221	0433 171 771	CP			6x0,15x148°	Nozzle CR
7190253	DLLA147P 1229	0433 171 779				6x0,24x147°	Nozzle
7190254	DLLA147P 1230	0433 171 780	CP	DLC		7x0,205x147°	Nozzle
719026	DLLA153P 1246++	0433 171 788	CP			7x0,14x153°	Nozzle CR
71903	DLLA152P 1286	0433 171 809	CP			8x0,19x152°	Nozzle
719033	DLLA146P 1297	0433 171 812	CP			5x0,245x146°	Nozzle
719038	DLLA146P 1339++	0433 171 831	CP	DLC		6x0,25x146°	Nozzle CR
7190389	DLLA150P 1351	0433 171 841	CP			5x0,19x150°	Nozzle
719039	DLLA150P 1352	0433 171 842	CP			5x0,20x150°	Nozzle
71904	DLLA156P 1368	0433 171 848	CP			6x0,19x156°	Nozzle CR
719041	DLLA156P 1368/		CP	DLC		6x0,175x156°	Nozzle CR
719044	DLLA158P 1385	0433 171 860	CP	DLC		7x0,155x158°	Nozzle CR
71905	DLLA143P 1404	0433 171 870	CP	DLC		6x0,19x143°	Nozzle CR
719050	DLLA146P 1405/	0433 171 871	CP	DLC		9x0,16x146°	Nozzle CR
719051	DLLA144P 1417	0433 171 878	CP	DLC		7x0,245x144°	Nozzle CR
7190512	DLLA140P 1420	0433 171 881	CP			8x,019x140°	Nozzle
719052	DLLA146P 1453	0433 171 900				6x0,31x146°	Nozzle
7190521	DLLA152P 1454	0433 171 901	CP			8x0,19x152°	Nozzle
719053	DLLA148P 1460	0433 171 904				6x0,275x148°	Nozzle
719054	DLLA148P 1461	0433 171 905				6x0,265x148°	Nozzle

<i>Our Ref.</i>	<i>Stamping</i>	<i>Part Number</i>	<i>CP</i>	<i>DLC</i>	<i>D/A</i>	<i>Technical Data</i>	<i>Description</i>
719055	DLLA148P 1462	0433 171 906				6x0,24x148°	Nozzle
7190551	DLLA155P 1493	0433 171 921	CP	DLC		6x0,15x155°	Nozzle CR
71905514	DLLA145P 1534	0433 171 946	CP			8x0,205x145°	Nozzle UIS
71905518	DLLA154P 1538	0433 171 948	CP			7x0,22x154°	Nozzle
7190552	DLLA145P 1540	0433 171 950	CP			8x0,16x145°	Nozzle UIS
71905523	DLLA144P 1565	0433 171 964	CP	DLC		8x0,20x144°	Nozzle CR
71905526	DLLA146P 1581	0433 171 968	CP	DLC		7x0,195x146°	Nozzle CR
7190553	DLLA122P 1602	0433 171 978	CP			7x0,22x122°	Nozzle
71905535	DLLA146P 1610	0433 171 984	CP	DLC		8x0,145x146°	Nozzle CR
7190554	DLLA150P 1622	0433 171 991	CP	DLC		8x0,185x150°	Nozzle CR
7190556	DLLA145P 1647	0433 172 010	CP	DLC		6x0,155x145°	Nozzle CR
7190558	DLLA142P 1654	0433 172 015	CP	DLC		8x0,175x142°	Nozzle CR
7190559	DLLA145P 1655	0433 172 016	CP	DLC		8x0,20x145°	Nozzle CR
719056	DLLA151P 1656	0433 172 017	CP	DLC		7x0,16x151°	Nozzle CR
7190566	DLLA150P 1666	0433 172 022	CP	DLC		6x0,16x150°	Nozzle CR
7190568	DLLA82P 1668	0433 172 024	CP	DLC		6x0,15x82°	Nozzle CR
719057	DLLA155P 1674	0433 172 026	CP	DLC		6x0,16x155°	Nozzle CR
7190578	DLLA145P 1686	0433 172 033	CP	DLC		7x0,165x145°	Nozzle CR
719058	DLLA148P 1688	0433 172 034	CP	DLC		7x0,17x148°	Nozzle CR
7190582	DLLA152P 1690	0433 172 036	CP	DLC		8x0,18x152°	Nozzle CR
7190583	DLLA118P 1691	0433 172 037	CP	DLC		5x0,20x118°	Nozzle CR
71905836	DLLA143P 1696	0433 172 039	CP	DLC		8x0,22x143°	Nozzle CR
71905837	DLLA118P 1697	0433 172 040	CP	DLC		5x0,22x118°	Nozzle CR
7190584	DLLA142P 1709	0433 172 047	CP	DLC		7x0,205x142°	Nozzle CR
7190585	DLLA150P 1712	0433 172 049	CP	DLC		8x0,225x150°	Nozzle CR
7190586	DLLA144P 1707	0433 172 045	CP	DLC		7x0,21x144°	Nozzle CR
7190588	DLLA153P 1721	0433 172 056	CP	DLC		8x0,195x153°	Nozzle CR
719059	DLLA146P 1724	0433 172 058	CP	DLC		7x0,205x146°	Nozzle CR
7190591	DLLA146P 1725	0433 172 059	CP	DLC		7x0,19x146°	Nozzle CR
719060	DLLA152P 1768	0433 172 078	CP	DLC		7x0,195x152°	Nozzle CR
719061	DLLA160P 1780	0433 172 087	CP	DLC		7x0,22x160°	Nozzle
7190611	DLLA150P 1781	0433 172 088	CP	DLC		7x0,155x150°	Nozzle CR
7190615	DLLA154P 1795	0433 172 094	CP	DLC		7x0,19x154°	Nozzle CR
719063	DLLA148P 1815	0433 172 108	CP	DLC		7x0,195x148°	Nozzle CR
7190634	DLLA152P 1819	0433 172 111	CP	DLC		7x0,21x152°	Nozzle CR
7190637	DLLA150P 1827	0433 172 115	CP	DLC		8x0,17x150°	Nozzle CR
7190638	DLLA150P 1828	0433 172 116	CP	DLC		8x0,17x150°	Nozzle CR
7190643	DLLA150P 2123	0433 172 123	CP	DLC		8x0,145x150°	Nozzle CR
7190645	DLLA146P 2145	0433 172 145	CP	DLC		Ø3.5 - 8x0,17x146°	Nozzle CR
71906456	DLLA141P 2146	0433 172 146	CP	DLC		8x0,15x141°	Nozzle CR
7190646	DLLA143P 2155	0433 172 155	CP	DLC		Ø3.5 - 8x0,17x143°	Nozzle CR
719065	DLLA149P 2166	0433 172 166	CP	DLC		8x0,215x149°	Nozzle CR
7190652	DLLA145P 2168	0433 172 168	CP	DLC		7x0,155x145°	Nozzle CR
719066	DLLA148P 2221	0433 172 221	CP	DLC		8x0,195x148°	Nozzle CR
7190662	DLLA150P 2259	0433 172 259	CP	DLC		8x0,16x150°	Nozzle CR
7190663	DLLA142P 2262	0433 172 262	CP	DLC		8x0,155x142°	Nozzle CR
7190665	DLLA144P 2273	0433 172 146	CP	DLC		7x0,21x144°	Nozzle CR
719067	DLLZ155P 4	0433 171 004				5x0,32x155°	Nozzle
719068	DLLZ157P 964	0433 171 638	CP	DLC		6x0,215x157°	Nozzle CR
71910	DSLA145P 006	F019 123 006				6x0,235x145°	Nozzle
71911	DSLA155P 84	0433 175 004				4x0,31x155°	Nozzle
71912	DSLA155P 104	0433 175 005				4x0,35x155°	Nozzle
71914	DSLA150P 143	0433 175 006				4x0,245x150°	Nozzle
71915	DSLA155P 170	0433 175 007				5x0,31x155°	Nozzle

Our Ref.	Stamping	Part Number	CP	DLC	D/A	Technical Data	Description
71916	DSLA150P 191+/-	0433 175 013	CP			5x0,21x150°	Nozzle 2 springs
71917	DSLA145P 208	0433 175 017				5x0,24x145°	Nozzle 2 springs
719171	DSLA160P 192	0433 175 014				5x0,31x160°	Nozzle
719176	DSLA124P 198	0433 175 016				4x0,28x124°	Nozzle
71918	DSLA150P 211	0433 175 018				5x0,26x150°	Nozzle
71919	DSLA148P 219	0433 175 020				6x0,30x148°	Nozzle
71931	DSLA150P 261	0433 175 029				5x0,24x150°	Nozzle 2 springs
719327	DSLA145P 263	0433 175 031				5x0,245x145°	Nozzle
71933	DSLA145P 265	0433 175 033				6x0,25x145°	Nozzle
71934	DSLA145P 268	0433 175 036				8x0,22x145°	Nozzle
719341	DSLA145P 269	0433 175 037				8x0,24x145°	Nozzle
719345	DSLA155P 276	0433 175 039				4x0,34x155°	Nozzle
719347	DSLA155P 278	0433 175 040				5x0,31x155°	Nozzle
71935	DSLA150P 280-	0433 175 042	CP			5x0,18x150°	Nozzle 2 springs
71936	DSLA140P 292	0433 175 044				5x0,27x140°	Nozzle
71937	DSLA150P 294	0433 175 046	CP			5x0,19x150°	Nozzle
71940	DSLA145P 300	0433 175 048				5x0,29x145°	Nozzle
71941	DSLA145P 311M					6x0,25x145°	Nozzle
71942	DSLA130P 320	0433 175 051				5x0,30x130°	Nozzle
71943	DSLA130P 321	0433 175 052				5x0,32x130°	Nozzle
71944	DSLA 78P 322	0433 175 053				1x0,52x78°	Nozzle
71950	DSLA145P 330	0433 175 054				5x0,23x145°	Nozzle
71957	DSLA150P 357	0433 175 058	CP			5x0,19x150°	Nozzle 2 springs
71962	DSLA150P 362	0433 175 059	CP			5x0,21x150°	Nozzle 2 springs
71964	DSLA145P 366	0433 175 061	CP			5x0,26x145°	Nozzle 2 springs
719665	DSLA145P 379	0433 175 062	CP			8x0,23x145°	Nozzle
719666	DSLA145P 380	0433 175 063				8x0,23x145°	Nozzle
719667	DSLA140P 381	0433 175 064				7x0,22x140°	Nozzle
719668	DSLA145P 396	0433 175 066				5x0,23x145°	Nozzle
719669	DSLA140P 400	0433 175 067				5x0,27x140°	Nozzle
71967	DSLA141P 405	0433 175 068				5x0,26x141°	Nozzle
719677	DSLA150P 442	0433 175 072	CP			5x0,185x150°	Nozzle 2 springs
71968	DSLA145P 446	0433 175 073				5x0,22x145°	Nozzle 2 springs
71969	DSLA150P 448	0433 175 074				5x0,23x150°	Nozzle
719691	DSLA145P 462	0433 175 076				5x0,23x145°	Nozzle
7196912	DSLA145P 463	0433 175 077				5x0,245x145°	Nozzle
7196914	DSLA145P 464	0433 175 078				5x0,23x145°	Nozzle
7196916	DSLA135P 468	0433 175 079				5x0,28x135°	Nozzle
719692	DSLA 88P 480	0433 175 082				4x0,31x88°	Nozzle
719693	DSLA148P 482	0433 175 083				5x0,225x148°	Nozzle
719694	DSLA154P 492/-	0433 175 085	CP			7x0,23x154°	Nozzle
719695	DSLA150P 502	0433 175 087	CP			5x0,21x150°	Nozzle 2 springs
719704	DSLA150P 520	0433 175 093	CP			5x0,205x150°	Nozzle 2 springs
719705	DSLA128P 523	0433 175 094				5x0,265x128°	Nozzle
719706	DSLA147P 535	0433 175 095	CP			5x0,19x147°	Nozzle 2 springs
71971	DSLA134P 546	0433 175 099				6x0,28x134°	Nozzle
719715	DSLA148P 575	0433 175 107	CP			5x0,22x148°	Nozzle 2 springs
719719	DSLA148P 591	0433 175 110	CP			5x0,22x148°	Nozzle 2 springs
71974	DSLA134P 604	0433 175 114				5x0,26x134°	Nozzle
71975	DSLA154P 620	0433 175 118				5x0,235x154°	Nozzle
71976	DSLA145P 626	0433 175 125				5x0,22x145°	Nozzle
71977	DSLA145P 631	0433 175 121	CP			5x0,21x145°	Nozzle 2 springs
719771	DSLA145P 631+	0433 175 121	CP			5x0,215x145°	Nozzle 2 springs
71978	DSLA135P 633	0433 175 122				5x0,265x135°	Nozzle

Our Ref.	Stamping	Part Number	CP	DLC	D/A	Technical Data	Description
71979	DSLA140P 640	0433 175 124				5x0,225x140°	Nozzle 2 springs
71980	DSLA150P 645	0433 175 130				5x0,25x150°	Nozzle
719803	DSLA150P 661	0433 175 136	CP			5x0,17x150°	Nozzle 2 springs
719805	DSLA150P 672	0433 175 139	CP			5x0,16x150°	Nozzle 2 springs
719806	DSLA150P 672-	0433 175 360	CP			5x0,16x150°	Nozzle 2 springs
719808	DSLA142P 683	0433 175 142	CP			5x0,18x142°	Nozzle 2 springs
71981	DSLA150P 706	0433 175 150	CP			5x0,175x150°	Nozzle 2 springs
71982	DSLA139P 710	0433 175 152	CP			5x0,215x139°	Nozzle 2 springs
719824	DSLA147P 716	0433 175 156	CP			5x0,19x147°	Nozzle 2 springs
719832	DSLA156P 736	0433 175 163	CP	DLC	D/A	6x0,175x156°	Nozzle CR
719833	DSLA156P 737	0433 175 164	CP	DLC	D/A	6x0,145x156°	Nozzle CR
719834	DSLA140P 741	0433 175 167	CP			8x0,19x140°	Nozzle
719835	DSLA145P 763	0433 175 175	CP	DLC		5x0,185x145°	Nozzle CR
719836	DSLA145P 763+		CP	DLC		5x0,185x145°	Nozzle CR
7198364	DSLA150P 764	0433 175 176	CP			5x0,21x150°	Nozzle 2 springs
719837	DSLA134P 772	0433 175 179				5x0,25x134°	Nozzle 2 springs
719838	DSLA150P 773	0433 175 180	CP			7x0,19x150°	Nozzle 2 springs
71984	DSLA134P 781	0433 175 188				6x0,28x134°	Nozzle 2 springs
719843	DSLA150P 783	0433 175 189	CP		D/A	5x0,19x150°	Nozzle UIS
71985	DSLA155P 789	0433 175 192	CP			5x0,145x155°	Nozzle CR
719851	DSLA142P 792	0433 175 194	CP			5x0,18x142°	Nozzle
719852	DSLA142P 795	0433 175 196	CP	DLC		5x0,18x142°	Nozzle CR
7198527	DSLA153P 797	0433 175 197	CP			7x0,195x153°	Nozzle
7198528	DSLA153P 798	0433 175 198	CP			7x0,195x153°	Nozzle
719853	DSLA150P 800/		CP		D/A	5x0,15x150°	Nozzle UIS
7198531	DSLA153P 801	0433 175 200	CP			7x0,185x153°	Nozzle
719854	DSLA153P 802	0433 175 201	CP			7x0,17x153°	Nozzle
7198543	DSLA153P 803	0433 175 202	CP	DLC		7x0,18x153°	Nozzle
7198544	DSLA136P 804		CP	DLC	D/A	5x0,205x136°	Nozzle CR
719855	DSLA136P 804/	0433 175 203	CP	DLC	D/A	5x0,205x136°	Nozzle CR
71986	DSLA134P 816	0433 175 208				6x0,28x134°	Nozzle
719861	DSLA153P 820	0433 175 210	CP			7x0,205x153°	Nozzle
719863	DSLA150P 838	0433 175 219	CP			5x0,205x150°	Nozzle 2 springs
719866	DSLA140P 862+	0433 175 230	CP	DLC		5x0,185x140°	Nozzle CR
719872	DSLA145P 882	0433 175 246	CP			6x0,205x145°	Nozzle 2 springs
719874	DSLA154P 960	0433 175 269				7x0,22x154°	Nozzle
719875	DSLA143P 970	0433 175 271	CP	DLC	D/A	8x0,16x143°	Nozzle CR
719876	DSLA144P 971+	0433 175 272	CP	DLC		6x0,15x144°	Nozzle CR
719878	DSLA144P 973+	0433 175 274	CP	DLC		6x0,155x144°	Nozzle CR
719879	DSLA158P 974+	0433 175 275	CP	DLC	D/A	7x0,165x158°	Nozzle CR
71988	DSLA145P 975	0433 175 276	CP			5x0,225x145°	Nozzle 2 springs
719887	DSLA128P 997					5x0,265x128°	Nozzle
719891	DSLA150P 1019	0433 175 291				5x0,21x150°	Nozzle 2 springs
719892	DSLA144P 1021	0433 175 288	CP	DLC		6x0,165x144°	Nozzle CR
719893	DSLA142P 1025	0433 175 294	CP		D/A	6x0,15x142°	Nozzle 2 springs
7198939	DSLA140P 1033/	0433 175 297	CP	DLC	D/A	6x0,18x140°	Nozzle CR
719894	DSLA154P 1034	0433 175 298	CP	DLC	D/A	6x0,175x154°	Nozzle CR
719895	DSLA144P 1037/	0433 175 300				5x0,24x144°	Nozzle
719897	DSLA150P 1042	0433 175 303	CP		D/A	5x0,19x150°	Nozzle UIS
719898	DSLA150P 1043	0433 175 304	CP		D/A	5x0,195x150°	Nozzle UIS
71990	DSLA143P 1058	0433 175 309	CP	DLC	D/A	8x0,16x143°	Nozzle CR
719914	DSLA145P 1091	0433 175 318	CP		D/A	5x0,20x145°	Nozzle CR
719917	DSLA145P 1097	0433 175 319	CP			7x0,19x145°	Nozzle
719923	DSLA150P 1103	0433 175 323	CP		D/A	6x0,21x150°	Nozzle 2 springs

Our Ref.	Stamping	Part Number	CP	DLC	D/A	Technical Data	Description
719925	DSLA140P 1112	0433 175 325	CP			5x0,215x140°	Nozzle 2 springs
719930	DSLA154P 1129/	0433 175 333	CP		D/A	6x0,13x154°	Nozzle CR
719931	DSLA140P 1131	0433 175 334	CP			5x0,125x140°	Nozzle CR
719935	DSLA150P 1156	0433 175 343	CP		D/A	5x0,185x150°	Nozzle UIS
719938	DSLA140P 1173	0433 175 347				5x0,23x140°	Nozzle
719941	DSLA144P 1213	0433 175 363	CP			6x0,16x144°	Nozzle CR
719947	DSLA150P 1247	0433 175 367	CP		D/A	5x0,17x150°	Nozzle UIS
7199471	DSLA150P 1248	0433 175 368	CP		D/A	5x0,19x150°	Nozzle UIS
719948	DSLA150P 1250	0433 175 369	CP			6x0,16x150°	Nozzle 2 springs
719950	DSLA152P 1287++	0433 175 379	CP			6x0,165x152°	Nozzle UIS
719951	DSLA144P 1295	0433 175 386	CP			6x0,165x144°	Nozzle CR
719953	DSLA151P 1302	0433 175 387	CP			6x0,215x151°	Nozzle
719954	DSLA124P 1309	0433 175 390	CP	DLC	D/A	5x0,21x124°	Nozzle CR
719956	DSLA154P 1320	0433 175 395	CP	DLC	D/A	6x0,17x154°	Nozzle CR
719959	DSLA146P 1409+	0433 175 414	CP		D/A	6x0,225x146°	Nozzle UIS
719961	DSLA156P 1411	0433 175 416	CP			8x0,16x156°	Nozzle
719963	DSLA146P 1440	F002 C40 586				6x0,24x146°	Nozzle UIS
719980	DSLA142P 1474	0433 175 431	CP			5x0,175x142°	Nozzle CR
719982	DSLA128P 1510	0433 175 449	CP	DLC		5x0,205x128°	Nozzle CR
719989	DSLA124P 1659	0433 175 470	CP	DLC	D/A	5x0,21x124°	Nozzle CR
719993	DSLA140P 1723	0433 175 481	CP	DLC	D/A	8x0,16x140°	Nozzle CR
719994	DSLA150P 1729	0433 175 484	CP			5x0,195x150°	Nozzle
719997	DSLA124P 5516	0433 175 516	CP	DLC	D/A	5x0,205x124°	Nozzle CR
719998	DSLA143P 5519	0433 175 519	CP	DLC	D/A	8x0,155x143°	Nozzle CR
NBD10092	DL140T 92	0433 300 132				7x0,30x140°	Nozzle
NBD10093	DL155T 92	0433 300 184				7x0.30x155°	Nozzle
NBD10126	DL140T 226	0433 300 136				8x0,35x140°	Nozzle
NBD10132	DL140T 232	0433 300 137				8x0,40x140°	Nozzle
NBD10160	DL140T 260	0433 300 138				8x0.30x140°	Nozzle
NBD10218	DL150T 418	0433 300 172				8x0.20x150°	Nozzle
NBD10455	DL110T 957	0433 300 056				8x0,25x110°	Nozzle
NBD10456	DL125T 957	0433 300 091				8x0.25x125°	Nozzle
NBD10457	DL150T 957	0433 300 180				8x0.25x150°	Nozzle
NBD10458	DL110T 958	0433 300 057				6x0,25x110°	Nozzle
NBD10459	DL150T 958	0433 300 181				6x0.25x150°	Nozzle
NBD10465	DL140T 965	0433 300 149				7x0.50x140°	Nozzle
NBD10515	DL160T 1015	0433 300 206				6x0,33x160°	Nozzle
NBD10523	DL150T 1023	0433 300 210				8x0.31x150°	Nozzle
NBD10571	DL125T 1071	0433 300 237				8x0,23x125°	Nozzle
NBD10619	DL140T 1119	0433 300 259				7x0.45x140°	Nozzle
NBD10621	DL145T 1121	0433 300 260				9x0,30x145°	Nozzle
NBD10625	DL110T 1125	0433 300 264				5x0.40x110°	Nozzle
NBD10629	DL140T 1129	0433 300 266				8x0.40x140°	Nozzle
NBD10639	DL150T 1139	0433 300 270				8x0.40x150°	Nozzle
NBD10652	DL130T 1152	0433 300 281				6x0.40x130°	Nozzle
NBD10655	DL140T 1155	0433 300 286				8x0,35x140°	Nozzle
NBD10667	DL110T 1167	0433 300 294				5x0,38x110°	Nozzle
NBD10669	DL145T 1169	0433 300 296				9x0,35x145°	Nozzle
NBD10672	DL140T 1172	0433 300 300				10x0,36x140°	Nozzle
NBD10686	DL155T 1186	0433 300 307				8x0,35x155°	Nozzle
NBD10687	DL145T 1187	0433 300 308				8x0,34x145°	Nozzle
NBD10690	DL110T 1190	0433 300 311				4x0.50x110°	Nozzle
NBD10691	DL135T 1191	0433 300 312				1+8x0.30x135°	Nozzle
NBD10697	DL150T 1197	0433 300 320				8x0.40x150°	Nozzle

Our Ref.	Stamping	Part Number	CP	DLC	D/A	Technical Data	Description
----------	----------	-------------	----	-----	-----	----------------	-------------

Bosch

NBD10698	DL145T 1198	0433 300 319				8x0.30x145°	Nozzle
NBD10701	DL145T 1201	0433 300 322				9x0.325x145°	Nozzle
NBD107011	DL145T 1201	0433 300 986				9x0.325x145°	Nozzle
NBD10703	DL145T 1203	0433 300 323				9x0.325x145°	Nozzle
NBD10705	DL145T 1205	0433 300 325				9x0.35x145°	Nozzle
NBD107051	DL145T 1205	0433 300 983				9x0.35x145°	Nozzle
NBD10706	DL155T 1206	0433 300 326				8x0.40x155°	Nozzle
NBD10715	DL130T 1215	0433 300 334				7x0.47x130°	Nozzle
NBD10729	DL155T 1229	0433 300 342				5x0.43x155°	Nozzle
NBD10743	DL155T 1243	0433 300 346				5x0.45x155°	Nozzle
NBD10748	DL155T 1248	0433 300 347				5x0.47x155°	Nozzle
NBD20007	DLLB145T 7	0433 371 007				8x0.375x145°	Nozzle
NBD24021	DLF145T 21	0433 351 024				8x0.34x145°	Nozzle
NBD24030	DLF160T 30	0433 351 033				7x0.34x160°	Nozzle
NBD24037	DLF145T 37	0433 351 040				8x0.30x145°	Nozzle
NBD25002	DLLF155T 2	0433 351 054				8x0.40x155°	Nozzle
NBD25003	DLLF155T 3	0433 351 055				8x0.35x155°	Nozzle
NBD25008	DLLF145T 8	0433 351 040				8x0.30x145°	Nozzle
NBD25009	DLLF145T 9	0433 351 051				8x0.38x145°	Nozzle
NBD27013	DLLZ150T 13	0433 371 013				10x0.38x150°	Nozzle
NBD27086	B433 120 086 C						Nozzle
NBD30132	DL130U 232	0433 400 044				8x0.40x130°	Nozzle
NBD30146	DL130U 246	0433 400 046				8x0.45x130°	Nozzle
NBD30156	DL150U 256	0433 400 076				9x0.45x150°	Nozzle
NBD30599	DL135U 1099	0433 400 110				8x0.53x135°	Nozzle
NBD30620	DL115U 1120	0433 400 116				6x0.45°x115°	Nozzle
NBD35006	DLF150U 6	0433 451 041				8x0.45x150°	Nozzle
NBD35044	DLF150U 44	0433 451 051				8x0.45x150°	Nozzle
NBD35045	DLF145U 45	0433 451 052				10x0.49x145°	Nozzle
NBD35561	DLF145VV-C3440061					9x0.69x145°	Nozzle
NBD36001	DLLA152U 1	0433 421 002				8x0.35x152°	Nozzle

Caterpillar

442006	Nozzle Assy. OR9348	HI300					Nozzle HEUI
442016	Nozzle Assy. OR9349	HI300					Nozzle HEUI
442026	Nozzle Assy. OR9350	HI300					Nozzle HEUI
59005	100 7556						Pencil nozzle
59006	100 7558						Pencil nozzle
59007	100 7559						Pencil nozzle
59009	130 5187						Pencil nozzle
59010	170 5181						Pencil nozzle
59011	170 5187						Pencil nozzle
59014	3S 6638	Group (Nozzle 8N5986)					Nozzle
59024	4W 7015						Pencil nozzle
59025	4W 7016						Pencil nozzle
59026	4W 7017						Pencil nozzle
59027	4W 7018						Pencil nozzle
59028	4W 7019						Pencil nozzle
59029	4W 7022						Pencil nozzle
59031	5F 2805						Nozzle
59034	5H 7936	Group (Nozzle 8N3173)					Nozzle
59040	6H 3364	Group (Nozzle 9H4113)					Nozzle
59046	7M 4601						Nozzle
59048	7M 7431	Group (Nozzle 7M4601)					Nozzle

Our Ref.	Stamping	Part Number	CP	DLC	D/A	Technical Data	Description
----------	----------	-------------	----	-----	-----	----------------	-------------

Caterpillar

59052	7N 9843						Nozzle
59059	7W 7026						Pencil nozzle
59060	7W 7032						Pencil nozzle
59061	7W 7037						Pencil nozzle
59064	8M 1584	Group (Nozzle 8N4697)					Nozzle
59066	8N 1831						Nozzle
59067	8N 3173						Nozzle
59068	8N 3175						Nozzle
59070	8N 3176						Nozzle
59072	8N 3177						Nozzle
59074	8N 4694						Nozzle
59076	8N 4697						Nozzle
590763	8N 5986						Nozzle
590768	8N 7003						Pencil nozzle
59077	8N 7005						Pencil nozzle
59078	8N 8796	Group (Nozzle 8N4694)					Nozzle
59080	9F 2393	Group (Nozzle 5F2805)					Nozzle
59082	9F 4113						Nozzle
59084	9L 6884						Nozzle
59086	9N 3246						Nozzle
59088	9N 6173						Nozzle
76440	106-7056		CP			6x0,18x152°	Nozzle HEUI
7941006	41006/32	OR 9348 - HI300	CP			6x0,17	Nozzle HEUI
7941016	41016/32	OR 9349 - HI300	CP			6x0,185	Nozzle HEUI
7941026	41026/32	OR 9350 - HI300	CP			6x0,17	Nozzle HEUI
7941036	41036/32	10R0781 - HI300	CP			6x0,19	Nozzle HEUI
7941046	41046/32	10R0782/10R1262 - HI300	CP			6x0,18	Nozzle HEUI

Continental

76503	M0003P153		CP	DLC		6x0,16x153°	Nozzle CR
76504	M0006P154	CP0628468185	CP	DLC		6x0,195x154°	Nozzle CR
76505	M0011P162		CP	DLC		7x0,125	Nozzle CR
765053	M0019P140	CP1200946415	CP	DLC		8x0,125x140°	Nozzle CR
76506	M0502P147.6		CP	DLC		6x0,125x147°	Nozzle CR
76510	M0604P142		CP	DLC		6x0,15	Nozzle CR
76511	M1001P152		CP	DLC		7x0,13x152°	Nozzle CR
76512	M1003P152		CP	DLC		7x0,11x152°	Nozzle CR
76515	M1600P150	CP0520564718	CP	DLC		6x0,19x150°	Nozzle CR
76520	V0600P142	CP0427353596	CP	DLC		5x0,165x140°	Nozzle CR
76530	V0605P144	CP0412591548	CP	DLC		6x0,12	Nozzle CR
76550	V0802P150	CP0307950949 6L	CP			6x0,27x150°	Nozzle CR
765503	V0802P150	CP0425746441 6L	CP			6x0,235x150°	Nozzle CR
765506	V0802P150	CP0734984167 6L	CP			6x0,195x150°	Nozzle CR
76553	V0203P152		CP		D/A	6x0,165x152°	Nozzle CR

Cummins

58014	3001314	PTK				10x.0085x10°	Nozzle cap
58024	3005963	PTK				10x.0075x10°	Nozzle cap
58036	3012536	PTD				8x.008x18°	Nozzle cap
58037	3012537	PTD				8x.0065x18°	Nozzle cap
58038	3012538	PTD				9x.008x18°	Nozzle cap
58045	3020793	PTD SV				8x.0055x4°	Nozzle cap
58051	3023556	PTD				9x.0085x18°	Nozzle cap
58068	3028068	PTD L-10				9x.007x10°	Nozzle cap

Our Ref.	Stamping	Part Number	CP	DLC	D/A	Technical Data	Description
----------	----------	-------------	----	-----	-----	----------------	-------------

Cummins

58085	3059423	PTD				8x.007x14°	Nozzle cap
58098	3069764	PTD SC				8x.007x14°	Nozzle cap
58116	3071046	PTD SC				7x.0073x14°	Nozzle cap
58175	3073575	PTD N				8x.0076x17°	Nozzle cap
58265	3275265	PTD SV				7x.0055x4°	Nozzle cap
58266	3275266	PTD SV				7x.006x4°	Nozzle cap

Delphi

42209	BDN0SPC 6209	5650091					Pintle nozzle
42236	BDN12SD 6236	5643085					Pintle nozzle
42290	BDN12SPC 6290	5651241					Pintle nozzle
42299	BDN4SD 6299	5643095					Pintle nozzle
42346	BDN4SD 6346	5643105					Pintle nozzle
42389	BDN0SPC 6389	5650300					Pintle nozzle
42453	BDN4SD 6453	5643320					Pintle nozzle
42459	BDN12SD 6459	5643330					Pintle nozzle
42517	BDN12SD 6517	5643450					Pintle nozzle
42577	BDN0SD 6577	5643410					Pintle nozzle
425771	BDN0SD 6577A	5643412					Pintle nozzle
425772	BDN0SD 6577B	5643413					Pintle nozzle
425773	BDN0SDC 6577C	5643414					Pintle nozzle
42596	BDN0SD 6596	5641870					Pintle nozzle
42651	BDN0SPC 6651	5650350					Pintle nozzle
42751	BDN0SD 6751	5641891					Pintle nozzle
427513	BDN0SD 6751C	5641906					Pintle nozzle
427515	BDN0SDC 6751E	5641915					Pintle nozzle
42769	BDN4SD 6769	5643069					Pintle nozzle
42843	BDN0SD 6843	5641901					Pintle nozzle
428433	BDN0SDC 6843C	5641905					Pintle nozzle
42849	BDN12SD 6849	5643073					Pintle nozzle
428493	BDN12SD 6849C	5643075					Pintle nozzle
428494	BDN12SDC 6849D	5643076					Pintle nozzle
42850	BDN0SD 6850	5641902					Pintle nozzle
428502	BDN0SD 6850B	5641903					Pintle nozzle
428503	BDN0SD 6850C	5641904					Pintle nozzle
428504	BDN0SDC 6850D	5641919					Pintle nozzle
42861	BDN12SD 6861	5643470					Pintle nozzle
428624	BDN12SD 6862D	5643091					Pintle nozzle
428633	BDN0SD 6863C	5641909					Pintle nozzle
428683	BDN4SDC 6868C	5643321					Pintle nozzle
428684	BDN4SDC 6868D	5643324					Pintle nozzle
428725	BDN12SD 6872E	5643482					Pintle nozzle
428743	BDN12SDC 6874C	5643100					Pintle nozzle
428783	BDN4SDC 6878C	5643322					Pintle nozzle
428784	BDN4SDC 6878D	5643325					Pintle nozzle
428864	BDN4SDC 6886D	5643326					Pintle nozzle
428874	BDN0SDC 6887D	5641921					Pintle nozzle
42897	BDN0SDC 6897	5641930					Pintle nozzle
42902	BDN0SDC 6902	5641934					Pintle nozzle
42903	BDN0SDC 6903	5641935					Pintle nozzle
49046	BDL30S 46	5611065					Nozzle
49054	BDL30S 54	5611070					Nozzle
49103	BDL130S 6003	5611475				3x0.25x130°	Nozzle
49133	BDL110S 6133	5611650				2x0.35x110°	Nozzle

<i>Our Ref.</i>	<i>Stamping</i>	<i>Part Number</i>	<i>CP</i>	<i>DLC</i>	<i>D/A</i>	<i>Technical Data</i>	<i>Description</i>
49167	BDL110S 6267	5611735				2x0,35x110°	Nozzle
49709	BDL110S 6709	5612162				2x0,34x110°	Nozzle
70000	BDLL150S 559	5620405				4x0,25x150°	Nozzle
70001	BDLL150S 609	5620465				4x0,30x150°	Nozzle
70002	BDLL150S 685S	5620621				4x0,28x150°	Nozzle
70003	BDLL120S 694	5620645				2x0,40x120°	Nozzle
70004	BDLL140S 6001	5620655				4x0,25x140°	Nozzle
70006	BDLL150S 6028	5620680				4x0,28x150°	Nozzle
70007	BDLL150S 6054	5620695				4x0,30x150°	Nozzle
70008	BDLL150S 6064	5620705				4x0,35x150°	Nozzle
70010	BDLL150S 6072B	5620722				4x0,30x150°	Nozzle
70011	BDLL150S 6078	5620725				4x0,28x150°	Nozzle
70012	BDLL135S 6092	5620741				3x0,35x135°	Nozzle
70013	BDLL150S 6097S	5620755				4x0,25x150°	Nozzle
70014	BDLL150S 6123	5620780				4x0,27x150°	Nozzle
70015	BDLL150S 6130A	5620790				4x0,35x150°	Nozzle
70016	BDLL150S 6138	5620805				4x0,30x150°	Nozzle
70017	BDLL150S 6144	5620810				4x0,26x150°	Nozzle
70018	BDLL150S 6156	5620835				4x0,40x150°	Nozzle
70019	BDLL150S 6159	5620840				4x0,25x150°	Nozzle
70020	BDLL160S 6173	5620855				4x0,25x160°	Nozzle
70021	BDLL150S 6176	5620860				4x0,27x150°	Nozzle
70022	BDLL140S 6183	5620865				3x0,27x140°	Nozzle
70023	BDLL140S 6192	5620890				4x0,20x140°	Nozzle
70024	BDLL140S 6193	5620895				4x0,25x140°	Nozzle
70025	BDLL150S 6194	5620900				4x0,28x150°	Nozzle
70026	BDLL140S 6205	5620915				4x0,29x140°	Nozzle
70027	BDLL140S 6205A	5620916				4x0,29x140°	Nozzle
700275	BDLL140S 6221	5620945				3x0,27x140°	Nozzle
70028	BDLL150S 6222	5620950				4x0,27x150°	Nozzle
70029	BDLL150S 6225	5620960				4x0,27x150°	Nozzle
70030	BDLL160S 6246	5620997				4x0,25x160°	Nozzle
70031	BDLL150S 6253	5620998				3x0,33x150°	Nozzle
70032	BDLL140S 6254	5621000				4x0,35x140°	Nozzle
70033	BDLL140S 6258	5621002				4x0,35x140°	Nozzle
70034	BDLL140S 6268	5621010				3x0,33x140°	Nozzle
70035	BDLL 80S 6273	5621018				2x0,27+2x0,32	Nozzle
70036	BDLL150S 6275	5621023				4x0,34x150°	Nozzle
70037	BDLL140S 6276	5621025				4x0,22x140°	Nozzle
70038	BDLL140S 6281	5621029				4x0,30x140°	Nozzle
70039	BDLL160S 6283	5621033				4x0,25x160°	Nozzle
70040	BDLL150S 6288A	5621036				4x0,27x150°	Nozzle
70041	BDLL176S 6297					4x0,25x140°	Nozzle
70042	BDLL140S 6298	5621046				3x0,28x140°	Nozzle
70043	BDLL150S 6302	5621047				3x0,42x150°	Nozzle
70044	BDLL135S 6303	5621050				3x0,43x135°	Nozzle
70045	BDLL140S 6306	5621057				4x0,35x140°	Nozzle
70047	BDLL150S 6310	5621065				4x0,27x150°	Nozzle
70048	BDLL150S 6317	5621072				3x0,30x150°	Nozzle
70049	BDLL150S 6318	5621074				4x0,40x150°	Nozzle
70050	BDLL120S 6325	5621080				4x0,27x120°	Nozzle
70051	BDLL150S 6329CF	5621085				4x0,25x150°	Nozzle
700519	BDLL150S 6347					4x0,41x150°	Nozzle
70052	BDLL150S 6348	5621098				4x0,43x150°	Nozzle

<i>Our Ref.</i>	<i>Stamping</i>	<i>Part Number</i>	<i>CP</i>	<i>DLC</i>	<i>D/A</i>	<i>Technical Data</i>	<i>Description</i>
70053	BDLL140S 6350	5621103				3x0,35x140°	Nozzle
70054	BDLL150S 6355	5621110				4x0,26x150°	Nozzle
70055	BDLL150S 6372	5621120				4x0,26x150°	Nozzle
70056	BDLL150S 6382	5621125				4x0,25x150°	Nozzle
70057	BDLL150S 6385A	5621181				4x0,32x150°	Nozzle
70058	BDLL160S 6394	5621206				4x0,27x160°	Nozzle
70059	BDLL150S 6395	5621208				4x0,35x150°	Nozzle
70060	BDLL150S 6397	5621212				4x0,36x150°	Nozzle
70061	BDLL160S 6402	5621225				4x0,25x160°	Nozzle
70062	BDLL150S 6403	5621227				4x0,29x150°	Nozzle
70063	BDLL150S 6407	5621229				4x0,30x150°	Nozzle
70064	BDLL150S 6408	5621231				4x0,27x150°	Nozzle
70065	BDLL 10S 6410A	5621236				1x0,58x10°	Nozzle
70066	BDLL176S 6414	5621243				4x0,28x140°	Nozzle
70067	BDLL140S 6417	5621245				4x0,28x140°	Nozzle
70068	BDLL140S 6422	5621251				4x0,30x140°	Nozzle
70069	BDLL140S 6423	5621253				4x0,28x140°	Nozzle
70070	BDLL150S 6429	5621260				4x0,27x150°	Nozzle
70071	BDLL140S 6433	5621280				4x0,27x140°	Nozzle
70072	BDLL150S 6435	5621285				4x0,28x150°	Nozzle
70073	BDLL150S 6438	5621290				4x0,30x150°	Nozzle
70074	BDLL140S 6439	5621295				3x0,25x140°	Nozzle
70075	BDLL150S 6443	5621330				4x0,29x150°	Nozzle
70076	BDLL140S 6445	5621335				4x0,26x140°	Nozzle
70077	BDLL150S 6448	5621345				4x0,30x150°	Nozzle
70078	BDLL140S 6455	5621405				4x0,23x140°	Nozzle
70079	BDLL150S 6457	5621407				4x0,34x150°	Nozzle
70081	BDLL150S 6469	5621510				4x0,27x150°	Nozzle
70082	BDLL140S 6471	5621512				4x0,31x140°	Nozzle
70083	BDLL150S 6471	5621511				4x0,33x150°	Nozzle
70084	BDLL150S 6472	5621513				4x0,29x150°	Nozzle
70085	BDLL150S 6476	5621517				4x0,31x150°	Nozzle
70086	BDLL160S 6492	5621535				4x0,30x160°	Nozzle
70087	BDLL150S 6495	5621538				4x0,38x150°	Nozzle
700871	BDLL150S 6501	5621544				4x0,29x150°	Nozzle
70088	BDLL150S 6502	5621545				4x0,32x150°	Nozzle
70089	BDLL150S 6506	5621549				4x0,29x150°	Nozzle
70090	BDLL150S 6507	5621550				4x0,28x150°	Nozzle
70091	BDLL150S 6508	5621551				4x0,35x150°	Nozzle
70092	BDLL 10S 6509	5621552				1x0,60x10°	Nozzle
70093	BDLL150S 6511	5621554				4x0,30x150°	Nozzle
70094	BDLL150S 6513	5621556				4x0,28x150°	Nozzle
70095	BDLL160S 6519	5621562				4x0,34x160°	Nozzle
70096	BDLL 18S 6522	5621565				1x0,57x18°	Nozzle
70097	BDLL150S 6542	5621585				4x0,33x150°	Nozzle
70098	BDLL150S 6545	5621588				4x0,30x150°	Nozzle
70099	BDLL160S 6550	5621593				5x0,29x160°	Nozzle
70100	BDLL160S 6551	5621594				4x0,30x160°	Nozzle
70101	BDLL150S 6552	5621595				4x0,35x150°	Nozzle
70102	BDLL150S 6554	5621597				4x0,25x150°	Nozzle
70103	BDLL150S 6555	5621598				4x0,27x150°	Nozzle
70104	BDLL150S 6556	5621599				4x0,28x150°	Nozzle
70105	BDLL150S 6557	5621600				4x0,28x150°	Nozzle
70106	BDLL150S 6561	5621604				4x0,25x150°	Nozzle

<i>Our Ref.</i>	<i>Stamping</i>	<i>Part Number</i>	<i>CP</i>	<i>DLC</i>	<i>D/A</i>	<i>Technical Data</i>	<i>Description</i>
70107	BDLL150S 6563	5621606				4x0,32x150°	Nozzle
70108	BDLL160S 6569	5621612				5x0,29x160°	Nozzle
70109	BDLL150S 6571	5621614				4x0,27x150°	Nozzle
70110	BDLL150S 6573	5621616				4x0,29x150°	Nozzle
70112	BDLL150S 6576C	5621620				4x0,28x150°	Nozzle
70114	BDLL140S 6581	5621626				4x0,30x140°	Nozzle
70115	BDLL150S 6582	5621625				4x0,26x150°	Nozzle
70116	BDLL160S 6584	5621628				4x0,26x160°	Nozzle
70117	BDLL150S 6589	5621634				4x0,35x150°	Nozzle
70118	BDLL150S 6591	5621636				4x0,31x150°	Nozzle
70119	BDLL140S 6592	5621637				4x0,28x140°	Nozzle
70120	BDLL150S 6594	5621639				4x0,40x150°	Nozzle
70121	BDLL150S 6599	5621646				4x0,30x150°	Nozzle
70122	BDLL150S 6600	5621647				4x0,30x150°	Nozzle
70123	BDLL150S 6601	5621648				4x0,46x150°	Nozzle
70124	BDLL150S 6602	5621649				4x0,28x150°	Nozzle
70125	BDLL 22S 6604	5621651				1x0,59x22°	Nozzle
70126	BDLL140S 6606	5621653				4x0,38x140°	Nozzle
70127	BDLL150S 6607	5621654				4x0,41x150°	Nozzle
70128	BDLL140S 6608A	5621670				4x0,33x140°	Nozzle
70129	BDLL140S 6609	5621656				4x0,35x140°	Nozzle
70130	BDLL140S 6611	5621657				4x0,32x140°	Nozzle
70131	BDLL150S 6613	5621659				4x0,40x150°	Nozzle
70132	BDLL150S 6617	5621663				4x0,30x150°	Nozzle
70133	BDLL150S 6618	5621664				4x0,32x150°	Nozzle
70135	BDLL140S 6622	5621669				4x0,30x140°	Nozzle
70137	BDLL140S 6630	5621678				4x0,31x140°	Nozzle
70138	BDLL150S 6634	5621682				4x0,35x150°	Nozzle
70139	BDLL150S 6639	5621685				4x0,30x150°	Nozzle
70140	BDLL150S 6641	5621687				5x0,36x150°	Nozzle
70141	BDLL140S 6644	5621691				4x0,34x140°	Nozzle
70142	BDLL150S 6649CF	5621696				4x0,31x150°	Nozzle
70143	BDLL150S 6654	5621701				4x0,35x150°	Nozzle
70144L	BDLL140S 6655	5621702				3x0,36x140°	Nozzle
70148	BDLL150S 6662	5621709				4x0,29x150°	Nozzle
70149	BDLL150S 6665	5621712				4x0,27x150°	Nozzle
70150	BDLL150S 6666	5621713				4x0,29x150°	Nozzle
70151	BDLL150S 6667CF	5621714				4x0,33x150°	Nozzle
70152	BDLL150S 6673	5621720				4x0,32x150°	Nozzle
70153	BDLL150S 6676	5621723				4x0,31x150°	Nozzle
70154	BDLL150S 6690	5621737				4x0,35x150°	Nozzle
70155	BDLL150S 6691	5621738				5x0,36x150°	Nozzle
70160	BDLL150S 6698	5621745				4x0,26x150°	Nozzle
70161	BDLL160S 6701	5621749				4x0,34x160°	Nozzle
70162	BDLL160S 6702	5621750				4x0,33x160°	Nozzle
70163	BDLL160S 6703	5621756				4x0,30x160°	Nozzle
70164	BDLL150S 6705CF	5621751				4x0,27x150°	Nozzle
70165	BDLL140S 6707	5621753				4x0,29x140°	Nozzle
70166	BDLL150S 6708C					4x0,32x150°	Nozzle
70167	BDLL150S 6712	5621759				4x0,39x150°	Nozzle
70168	BDLL150S 6713	5621764				4x0,29x150°	Nozzle
70169	BDLL150S 6718CF	5621765				4x0,34x150°	Nozzle
70171	BDLL150S 6730CF	5621777				4x0,31x150°	Nozzle
70172	BDLL150S 6734	5621780				4x0,35x150°	Nozzle

<i>Our Ref.</i>	<i>Stamping</i>	<i>Part Number</i>	<i>CP</i>	<i>DLC</i>	<i>D/A</i>	<i>Technical Data</i>	<i>Description</i>
70173	BDLL150S 6737CF	5621784				4x0,30x150°	Nozzle
70174	BDLL150S 6738	5621785				4x0,29x150°	Nozzle
70175	BDLL150S 6740	5621787				4x0,22x150°	Nozzle
701751	BDLL150S 6741CF	5621789				4x0,31x150°	Nozzle
70176	BDLL150S 6743	5621791				4x0,26x150°	Nozzle
701762	BDLL150S 6745	5621792				4x0,27x150°	Nozzle
70178	BDLL150S 6764	5621807				4x0,32x150°	Nozzle
701783	BDLL140S 6768	5621812				4x0,35x140°	Nozzle
70179	BDLL150S 6771	5621814				4x0,27x150°	Nozzle
70180	BDLL150S 6774CF	5621821				4x0,30x150°	Nozzle
70181	BDLL150S 6780CF	5621827				4x0,27x150°	Nozzle
70182	BDLL150S 6781CF	5621828				4x0,35x150°	Nozzle
701823	BDLL150S 6786	5621829				4x0,31x150°	Nozzle
70183	BDLL150S 6789	5621836				6x0,33x150°	Nozzle
70184	BDLL150S 6790CF	5621837				4x0,32x150°	Nozzle
70185	BDLL150S 6792	5621840				4x0,31x150°	Nozzle
701851	BDLL150S 6802	5621849				4x0,31x150°	Nozzle
70186	BDLL150S 6803	5621850				4x0,31x150°	Nozzle
70187	BDLL155S 6807CF	5621854				4x0,28x155°	Nozzle
701872	BDLL150S 6808	5621855				5x0,43x150°	Nozzle
70188	BDLL150S 6812	5621858				4x0,33x150°	Nozzle
70189	BDLL150S 6815	5621861				4x0,31x150°	Nozzle
70190	BDLL150S 6817	5621862				4x0,28x150°	Nozzle
701901	BDLL150S 6826	5621868				5x0,32x150°	Nozzle
701902	BDLL150S 6828CF	5621869				4x0,29x150°	Nozzle
70191	BDLL150S 6829	5621870				4x0,26x150°	Nozzle
701918	BDLL150S 6833CF	5621873				4x0,50x150°	Nozzle
70192	BDLL140S 6835	5621876				4x0,39x140°	Nozzle
701921	BDLL150S 6837	5621877				4x0,30x150°	Nozzle
70193	BDLL150S 6839	5621889				4x0,29x150°	Nozzle
701931	BDLL150S 6840	5621890				4x0,32x150°	Nozzle
70194	BDLL150S 6841	5621891				4x0,31x150°	Nozzle
70196	BDLL150S 6846	5621897				6x0,33x150°	Nozzle
70197C	BDLL124S 6857					4x0,30x124°	Nozzle
70198C	BDLL136S 6858	6801063				3x0,36x136°	Nozzle
70274	BDLL150S 7574	5621707				4x0,29x150°	Nozzle
70299	BDLL150S 7919	5621874				4x0,30x150°	Nozzle
70300C	DPN 5225					5x0,29x148°	Nozzle
70314	L058 PBA	L058 PBA				5x0,25x143°	Nozzle
70316	L060 PBA	L060 PBA				5x0,29x140°	Nozzle
70317	L061 PBA	L061 PBA				5x0,29x143°	Nozzle
70318	L062 PBA	L062 PBA				5x0,24x145°	Nozzle
70319	L063 PBA	L063 PBA				5x0,28x138°	Nozzle
70320	L064 PBA	L064 PBA				5x0,24x144°	Nozzle
70321	L065 PBA	L065 PBA				5x0,30x144°	Nozzle
70322	L066 PBA	L066 PBA				5x0,28x129°	Nozzle
70323	L067 PBA	L067 PBA				5x0,265x143°	Nozzle
70324	L068 PBA	L068 PBA				5x0,26x139°	Nozzle
70326	L069 PBA	L069 PBA				5x0,29x139°	Nozzle
70327	L070 PBA	L070 PBA				5x0,30x141°	Nozzle
70328	L072 PBA	L072 PBA				5x0,25x140°	Nozzle
70329	L074 PBA	L074 PBA				6x0,205x154°	Nozzle
70340	L104 PBA	L104 PBA				5x0,24x145°	Nozzle
70342	L130 PBA	L130 PBA				5x0,24x136°	Nozzle

Our Ref.	Stamping	Part Number	CP	DLC	D/A	Technical Data	Description
70343	L131 PBA	L131 PBA				5x0,26x140°	Nozzle
70344	L155 PBA	L155 PBA				6x0,25x142°	Nozzle
703447	L158 PBA	L158 PBA				6x0,22x140°	Nozzle
70345	L276 PBA	L276 PBA				5x0,25x132°	Nozzle
70350	L010 PBB	L010 PBB	CP			6x0,21x141°	Nozzle EUI
70351	L011 PBB	L011 PBB	CP			6x0,235x141°	Nozzle EUI
70354	L014 PBB	L014 PBB	CP			6x0,23x152°	Nozzle EUI
70357	L017 PBB	L017 PBB	CP			6x0,23x152°	Nozzle EUI
70358	L018 PBB	L018 PBB	CP			6x0,23x153°	Nozzle EUI
70360	L024 PBB	L024 PBB	CP			6x0,195x152°	Nozzle EUI
70361	L029 PBB	L029 PBB	CP			8x0,21x151°	Nozzle EUI
703642	L092 PBB	L092 PBB	CP			8x0,185x140°	Nozzle E-Tech
703648	L098 PBB	L098 PBB	CP			8x0,205x140°	Nozzle E-Tech
703652	L126 PBB	L126 PBB	CP			6x0,245x150°	Nozzle EUI
70370	L025 PBC	L025 PBC	CP			5x0,26x150°	Nozzle EUI
703702	L028 PBC	L028 PBC	CP			5x0,28x145°	Nozzle EUI
7037025	L038 PBC	L038 PBC	CP			5x0,235	Nozzle EUI
703703	L045 PBC	L045 PBC	CP			6x0,25x150°	Nozzle EUI
7037036	L048 PBC	L048 PBC	CP			6x0,24x150°	Nozzle EUI
703704	L051 PBC	L051 PBC	CP			5x0,245x152°	Nozzle EUI
7037041	L053 PBC	L053 PBC	CP			7x0,21x150°	Nozzle EUI
7037042	L071 PBC	L071 PBC	CP			5x0,19x145°	Nozzle EUI
7037044	L193 PBC	L193 PBC	CP			6x0,25x150°	Nozzle EUI
7037045	L194 PBC	L194 PBC	CP			6x0,23x150°	Nozzle EUI
7037046	L195 PBC	L195 PBC	CP			6x0,22x155°	Nozzle EUI
7037049	L209 PBC	L209 PBC	CP			5x0,245x150°	Nozzle EUI
703705	L210 PBC	L210 PBC	CP			5x0,255x152°	Nozzle EUI
7037052	L211 PBC	L211 PBC	CP			5x0,225x152°	Nozzle EUI
7037055	L215 PBC	L215 PBC	CP			5x0,26x152°	Nozzle EUI
703706	L216 PBC	L216 PBC	CP			5x0,27x151°	Nozzle EUI
7037061	L216 PBC		CP	DLC		5x0,27x151°	Nozzle EUI
703708	L221 PBC	L221 PBC	CP			5x0,26x150°	Nozzle EUI
7037082	L222 PBC	L222 PBC	CP			5x0,25x150°	Nozzle EUI
703709	L225 PBC	L225 PBC	CP			6x0,25x124°	Nozzle EUI
703710	L226 PBC	L226 PBC	CP			6x0,265x155°	Nozzle EUI
703711	L234 PBC	L234 PBC	CP			5x0,24x154°	Nozzle EUI
7037114	L322 PBC	L322 PBC	CP			6x0,245x150°	Nozzle EUI
7037115	L325 PBC	L325 PBC	CP			6x0,23x152°	Nozzle EUI
703712	L076 PBD	25780B	CP			6x0,15x154°	Nozzle 2 springs
703714	L079 PBD	5852A	CP			5x0,18x150°	Nozzle 2 springs
703716	L087 PBD	C14238	CP			5x0,145x138°	Nozzle CR
703721	L096 PBD	L096 PBD	CP			6x0,15x155°	Nozzle CR
703722	L097 PBD	D2183	CP			6x0,145x141°	Nozzle CR
703728	L120 PBD	F1595	CP			5x0,11x165°	Nozzle CR
703729	L121 PBD	L121 PBD	CP			6x0,15x155°	Nozzle CR
703733	L133 PBD	22655E	CP			6x0,15x154°	Nozzle CR
703734	L135 PBD	L135 PBD	CP			7x0,13x155°	Nozzle CR
70374	LP004 B	LP004 B	CP			8x0,19x157°	Nozzle EUI
70380	L087 PRD	L087 PRD	CP			5x0,145x145°	Nozzle CR
70385	L281 PRD	L281 PRD	CP			7x0,125x155°	Nozzle CR
70401C	6801001	RB6801001				2x0,36+2x0,40	Nozzle
70403	6801011	JB6801011				4x0,35x149°	Nozzle
70404	6801012	JB6801012				4x0,27x150°	Nozzle
70405	6801014	JB6801014				3x0,34x147°	Nozzle

<i>Our Ref.</i>	<i>Stamping</i>	<i>Part Number</i>	<i>CP</i>	<i>DLC</i>	<i>D/A</i>	<i>Technical Data</i>	<i>Description</i>
Delphi							
70407	6801016	JB6801016				4x0,33x149°	Nozzle
70408	6801017	JB6801017				4x0,34x150°	Nozzle
70409	6801018	JB6801018				4x0,30x150°	Nozzle
70410	6801019	JB6801019				4x0,30x150°	Nozzle
70411	6801022	JB6801022				4x0,30x148°	Nozzle
70413	6801024	JB6801024				4x0,24x154°	Nozzle
70415	6801026	JB6801026				4x0,41x138°	Nozzle
70416	6801027	JB6801027				4x0,29x150°	Nozzle
70419	6801029	JB6801029				4x0,27x147°	Nozzle
70422	6801032	JB6801032				4x0,31x150°	Nozzle
70424	6801034	JB6801034				4x0,37x136°	Nozzle
70425	6801047	JB6801047				4x0,31x150°	Nozzle
704253	6801051	JB6801051				4x0,40x128°	Nozzle
704254	6801052	JB6801052				4x0,30x128°	Nozzle
704254C	6801053	6801053				4x0,25x161°	Nozzle
704255	6801057	JB6801057				4x0,29x140°	Nozzle
704256	6801058	JB6801058				4x0,30x148°	Nozzle
70426	6801060	JB6801060				4x0,34x156°	Nozzle
704261	6801061	JB6801061				4x0,26x157°	Nozzle
70427	6801072	JB6801072				5x0,29x150°	Nozzle
70428	6801075	JB6801075				4x0,38x154°	Nozzle
70430	6801079	JB6801079				4x0,29x156°	Nozzle
70432	6801081	JB6801081				4x0,25x160°	Nozzle
70433	6801082	JB6801082				4x0,34x147°	Nozzle
704334	6801084	JB6801084				4x0,28x143°	Nozzle
704337	6801087	JB6801087				5x0,29x146°	Nozzle
704338	6801088	JB6801088				4x0,30x142°	Nozzle
70434	6801093	JB6801093				4x0,33x147°	Nozzle
704345	6801100	JB6801100				4x0,33x139°	Nozzle
70435	6801104	JB6801104				4x0,32x142°	Nozzle
704356	6801106	JB6801106				4x0,29x149°	Nozzle
704362	6801110	JB6801110				4x0,29x140°	Nozzle
7043621	6801111	JB6801111				4x0,25x145°	Nozzle
7043622	6801112E	JB6801112E				4x0,26x154°	Nozzle
7043628	6801118	JB6801118				4x0,31x154°	Nozzle
704363	6801111	JB6801111				4x0,25x145°	Nozzle
7043631	6801121	JB6801121				4x0,29x159°	Nozzle
7043632	6801122	JB6801122				4x0,28x155°	Nozzle
7043633	6801123	JB6801123				4x0,37x157°	Nozzle
7043639	6801124	JB6801124				4x0,345x157°	Nozzle
7043640	6801127	JB6801127				4x0,39x157°	Nozzle
7043641	6801128	JB6801128				4x0,28x149°	Nozzle
7043644	6801130	JB6801130				4x0,26x153°	Nozzle
7043645	6801131	JB6801131				6x0,28x149°	Nozzle
7043647	6801133	JB6801133				4x0,27x149°	Nozzle
7043648	6801134	JB6801134				5x0,27x154°	Nozzle
704365	6801135	JB6801135				5x0,29x150°	Nozzle
704366	6801148	JB6801148				5x0,29x150°	Nozzle
704367	6801157	JB6801157				4x0,33x145°	Nozzle
704368	6801164	JB6801164				5x0,25x150°	Nozzle
704368C	6801172	6801172				4x0,25x160°	Nozzle
704369	6801173	JB6801173				4x0,28x150°	Nozzle
70437	6801175	JB6801175				4x0,25x146°	Nozzle
70438	6801176	JB6801176				4x0,28x144°	Nozzle

Our Ref.	Stamping	Part Number	CP	DLC	D/A	Technical Data	Description
Delphi							
70439	6809409	JB6809409				3x0,32x136°	Nozzle
70448	6950708	JB6950708				4x0,39x130°	Nozzle
706381C	BDLLA150S 308	5628927				5x0,34x150°	Nozzle
706382C	BDLLA150S 310	5628928				5x0,35x150°	Nozzle
706384C	BDLLA150S 312	5628929				5x0,27x150°	Nozzle
NDL10286	BDL35T 486					3x0,50x35°	Nozzle
NDL10407	BDL160T 6087					6x0,33x160°	Nozzle
NDL10532	BDL140T 6332					6x0,43x140°	Nozzle
NDL20503	BDLL130T 6331					7+1x0,35x130°	Nozzle

Denso							
43080	ND-DN4SD24ND 80	093400-0800					Pintle nozzle
43090	ND-DN4SDND 90	093400-0900					Pintle nozzle
43133	ND-DN4SDND 133	093400-1330					Pintle nozzle
43135	ND-DN4SDND 135	093400-1350					Pintle nozzle
43146	ND-DN4SDND 146	093400-1460					Pintle nozzle
43177	ND-DN0SDN 177	093400-1770					Pintle nozzle
43187	ND-DN0SDN 187	093400-2910					Pintle nozzle
43332	DN20PD 32	093400-5420					Nozzle
43337	DN0PD 37	093400-5370					Nozzle
43358	DN0PD 58	093400-5580					Nozzle
43373	DN0PD 628	093400-6330					Nozzle
43381	DN4PD 681	093400-6810					Nozzle
73603	ND-DLLA150S3840ND 52	093400-0520				2x0,38+2x0,40	Nozzle
73605	ND-DLLA150S384ND 57	093400-0570				4x0,38x150°	Nozzle
73610	ND-DLLA150S3840ND 70	093400-0700				2x0,38+2x0,40	Nozzle
73615	ND-DLLA150S3133ND 73	093400-0730				2x0,31+2x0,32	Nozzle
73619	ND-DLLA150S3739ND82	093400-0820				2x0,37+2x0,39x150°	Nozzle
73625	ND-DLLA160S295ND 96	093400-0960				5x0,29x160°	Nozzle
73630	ND-DLLA150S3133ND 97	093400-0970				2x0,31+2x0,33	Nozzle
73638	ND-DLLA150S325ND 117	093400-1170				5x0,32x150°	Nozzle
73639	ND-DLLA150S414ND 118	093400-1180				2x0,37+2x0,41	Nozzle
73640	ND-DLLA154S324ND 119	093400-1190				4x0,32x154°	Nozzle
73653	ND-DLLA150S315ND 145	093400-1450				5x0,32x150°	Nozzle
736537	ND-DLLA160S295ND 147	093400-1470				5x0,29x160°	Nozzle
736549	ND-DLLA160S295ND 152	093400-1520				5x0,29x160°	Nozzle
73655	ND-DLLA142S344ND 153	093400-1530				4x0,34x142°	Nozzle
73656	ND-DLLA150SND 154	093400-1540				4x0,41x150°	Nozzle
73659	ND-DLLA142S315ND 159	093400-1590				5x0,31x142°	Nozzle
73660	ND-DLLA155SND 160	093400-1600				5x0,34x155°	Nozzle
73670	ND-DLLA160SND 171	093400-1710				5x0,29x160°	Nozzle
73681	ND-DLLA160SND 181	093400-1810				5x0,31x160°	Nozzle
73686	ND-DLLA155SND 199	093400-1991				5x0,30x155°	Nozzle
73687	ND-DLLA150SND 200	093400-2002				6x0,30x150°	Nozzle
73689	ND-DLLA150SND 227	093400-2270				5x0,29x150°	Nozzle
736892	ND-DLLA150SND 228	093400-2282				5x0,29x150°	Nozzle
73691	ND-DLLA150SND 229	093400-2292				5x0,29x150°	Nozzle
73693	ND-DLLA160SND 243	093400-2431				5x0,33x160°	Nozzle
73694	ND-DLLA160SND 249	093400-2490				5x0,31x160°	Nozzle
73695	ND-DLLA157SND 250	093400-2500				5x0,31x157°	Nozzle
73697	ND-DLLA155SND 263	093400-2630				5x0,27x155°	Nozzle
73698	ND-DLLA157SND 297	093400-2970				6x0,25x157°	Nozzle
73703	ND-DLLA160P 3	093400-5030				5x0,29x160°	Nozzle
73709	ND-DLLA150P 9	093400-5090				4x0,31x150°	Nozzle

Our Ref.	Stamping	Part Number	CP	DLC	D/A	Technical Data	Description
73716	ND-DLLA155P 16	093400-5160				5x0,26x155°	Nozzle
73724	ND-DLLA150P 24	093400-5240				5x0,26x150°	Nozzle
73725	ND-DLLA160P 25	093400-5250				5x0,28x160°	Nozzle
73735	ND-DLLA150P 35	093400-5350				5x0,27x150°	Nozzle
73750	ND-DLLA160P 50	093400-5500				5x0,29x160°	Nozzle
73759	ND-DLLA150P 59	093400-5590				4x0,31x150°	Nozzle
73761	ND-DLLA150P 61	093400-5611				4x0,29x150°	Nozzle
73763	ND-DLLA152P 69	093400-5690				5x0,29x152°	Nozzle
73765	ND-DLLA150P 77	093400-5770				5x0,30x150°	Nozzle
737652	ND-DLLA160P 79	093400-5790				5x0,275x160°	Nozzle
73769	ND-DLLA148P 99	093400-5990				7x0,23x148°	Nozzle
73782	ND-DLLA150P 602	093400-6020				5x0,26x150°	Nozzle
73795	ND-DLLA158P 615	093400-6150				7x0,25x158°	Nozzle
737956	ND-DLLA158P 616	093400-6160	CP			7x0,22x158°	Nozzle
73796	ND-DLLA158P 617	093400-6170	CP			7x0,255x158°	Nozzle
737965	ND-DLLA155P 631	093400-6310				4x0,28x155°	Nozzle
737968	ND-DLLA155P 638	093400-6380				5x0,24x155°	Nozzle
73797	ND-DLLA145P 639	093400-6390	CP			6x0,23x145°	Nozzle
73798	ND-DLLA140P 643	093400-6430				5x0,29x140°	Nozzle
73805	ND-DLLA148P 662	093400-6620	CP			7x0,215x148°	Nozzle
73807	ND-DLLA150P 671	093400-6710				5x0,27x150°	Nozzle
73809	ND-DLLA154P 674	093400-6740				5x0,26x154°	Nozzle
73810	ND-DLLA155P 683	093400-6830				6x0,265x155°	Nozzle CR
73811	ND-DLLA155P 706	093400-7060	CP			6x0,22x155°	Nozzle CR
73812	ND-DLLA154P 717	093400-7170	CP			5x0,215x154°	Nozzle CR
738121	ND-DLLA154P 717		CP	DLC		5x0,215x154°	Nozzle CR
73815	ND-DLLA144P 720	093400-7200	CP			7x0,185x144°	Nozzle CR
73818	ND-DLLA145P 748	093400-7480	CP			6x0,22x145°	Nozzle CR
73821	ND-DLLA143P 761	093400-7610				6x0,285x143°	Nozzle CR
73823	ND-DLLA148P 763	093400-7630	CP			7x0,185x148°	Nozzle CR
73824	ND-DLLA148P 764	093400-7640	CP			7x0,20x148°	Nozzle CR
738241	ND-DLLA148P 765	093400-7650	CP			6x0,185x148°	Nozzle CR
73825	ND-DLLA147P 788	093400-7880	CP			6x0,15x147°	Nozzle CR
738251	ND-DLLA147P 788		CP	DLC		6x0,15x147°	Nozzle CR
738253	ND-K03-905		CP			7x0,135x153°	Nozzle CR
73826	ND-K11-766		CP			6x0,145x147°	Nozzle CR
73829	ND-DLLA142P 793	093400-7930	CP			6x0,235x142°	Nozzle CR
73837	ND-DLLA155P 807	093400-8070	CP			7x0,145x155°	Nozzle CR
738371	ND-DLLA155P 807		CP	DLC		7x0,145x155°	Nozzle CR
73840	ND-DLLA148P 817	093400-8170	CP			6x0,13x148°	Nozzle CR
738401	ND-DLLA148P 817		CP	DLC		6x0,13x148°	Nozzle CR
738409	ND-DLLA158P 834	093400-8340	CP	DLC		8x0,22x158°	Nozzle CR
73841	ND-DLLA150P 835	093400-8350	CP	DLC		6x0,205x150°	Nozzle CR
738417	ND-DLLA155P 840	093400-8400	CP	DLC		6x0,165x155°	Nozzle CR
73842	ND-DLLA155P 842	093400-8420	CP	DLC		6x0,195x155°	Nozzle CR
73843	ND-DLLA158P 844	093400-8440	CP			7x0,12x158°	Nozzle CR
738431	ND-DLLA158P 844		CP	DLC		7x0,12x158°	Nozzle CR
73844	ND-DLLA155P 848	093400-8480	CP	DLC		6x0,175x155°	Nozzle CR
738441	ND-DLLA155P 848	093400-8480	CP			6x0,17x155°	Nozzle CR
73845	ND-DLLA142P 852	093400-8520	CP			6x0,25x142°	Nozzle CR
738451	ND-DLLA142P 852		CP	DLC		6x0,25x142°	Nozzle CR
738454	ND-DLLA158P 854	970950-0547	CP			7x0,16x158°	Nozzle CR
7384541	ND-DLLA158P 854		CP	DLC		7x0,16x158°	Nozzle CR
73846	ND-DLLA157P 855	093400-8550	CP	DLC		6x0,155x157°	Nozzle CR

<i>Our Ref.</i>	<i>Stamping</i>	<i>Part Number</i>	<i>CP</i>	<i>DLC</i>	<i>D/A</i>	<i>Technical Data</i>	<i>Description</i>
73849	ND-DLLA150P 861	093400-8610				5x0,25x150°	Nozzle
738491	ND-DLLA152P 862	093400-8620	CP			6x0,15x152°	Nozzle CR
7384911	ND-DLLA152P 862		CP	DLC		6x0,15x152°	Nozzle CR
738493	ND-DLLA155P 863	093400-8630	CP			8x0,14x155°	Nozzle CR
7384931	ND-DLLA155P 863		CP	DLC		8x0,14x155°	Nozzle CR
738494	ND-DLLA145P 864	093400-8640	CP			6x0,145x145°	Nozzle CR
7384941	ND-DLLA145P 864		CP	DLC		6x0,145x145°	Nozzle CR
738495	ND-DLLA152P 865	093400-8650	CP			8x0,21x152°	Nozzle CR
7384951	ND-DLLA152P 865		CP	DLC		8x0,21x152°	Nozzle CR
738496	ND-DLLA150P 866	093400-8660	CP	DLC		6x0,18x150°	Nozzle CR
738497	ND-DLLA145P 870	093400-8700	CP			6x0,16x145°	Nozzle CR
7384971	ND-DLLA145P 870		CP	DLC		6x0,16x145°	Nozzle CR
738498	ND-DLLA148P 872	093400-8720	CP	DLC		8x0,16x148°	Nozzle CR
738499	ND-DLLA145P 875	093400-8750	CP			6x0,17x145°	Nozzle CR
7384991	ND-DLLA145P 875		CP	DLC		6x0,17x145°	Nozzle CR
73851	ND-DLLA153P 884	093400-8840	CP			7x0,12x153°	Nozzle CR
738510	ND-DLLA153P 884		CP	DLC		7x0,12x153°	Nozzle CR
738511	ND-DLLA153P 885	093400-8850	CP	DLC		7x0,15x153°	Nozzle CR
73852	ND-DLLA139P 887	093400-8870	CP	DLC		6x0,185x139°	Nozzle CR
73855	ND-DLLA156P 905	093400-9050	CP			7x0,175x156°	Nozzle CR
738551	ND-DLLA156P 905		CP	DLC		7x0,175x156°	Nozzle CR
73856	ND-DLLA150P 906	093400-9060	CP			6x0,20x150°	Nozzle CR
73857	ND-DLLA148P 915	093400-9150	CP			6x0,215x148°	Nozzle CR
738571	ND-DLLA148P 915		CP	DLC		6x0,215x148°	Nozzle CR
73858	ND-DLLA150P 927	093400-9270	CP			8x0,175x150°	Nozzle CR
738581	ND-DLLA150P 927		CP	DLC		8x0,175x150°	Nozzle CR
738583	ND-DLLA148P 932	093400-9320	CP			8x0,13x148°	Nozzle CR
7385831	ND-DLLA148P 932		CP	DLC		8x0,13x148°	Nozzle CR
73859	ND-DLLA127P 944	093400-9440	CP			5x0,18x127°	Nozzle CR
738591	ND-DLLA127P 944		CP	DLC		5x0,18x127°	Nozzle CR
738593	ND-DLLA152P 947	093400-9470	CP	DLC		8x0,155x152°	Nozzle CR
738595	ND-DLLA151P 955	093400-9550	CP			7x0,135x151°	Nozzle CR
7385951	ND-DLLA151P 955		CP	DLC		7x0,135x151°	Nozzle CR
738609	ND-DLLA155P 964	093400-9640	CP			7x0,18x155°	Nozzle CR
7386091	ND-DLLA155P 964		CP	DLC		7x0,18x155°	Nozzle CR
73861	ND-DLLA155P 965	093400-9650	CP			8x0,21x155°	Nozzle CR
738611	ND-DLLA155P 965		CP	DLC		8x0,21x155°	Nozzle CR
73862	ND-DLLA150P 966	093400-9660	CP			6x0,135x150°	Nozzle CR
738621	ND-DLLA150P 966		CP	DLC		6x0,135x150°	Nozzle CR
73867	ND-DLLA153P 977	093400-9770	CP			7x0,17x153°	Nozzle CR
738671	ND-DLLA153P 977		CP	DLC		7x0,17x153°	Nozzle CR
73870	ND-DLLA152P 980	093400-9800	CP	DLC		6x0,15x152°	Nozzle CR
73871	ND-DLLA152P 981	093400-9810	CP	DLC		6x0,145x152°	Nozzle CR
73873	ND-DLLA150P 991	093400-9910	CP	DLC		6x0,23x150°	Nozzle CR
73876	ND-DLLA145P 1024	093400-1024	CP	DLC		6x0,145x145°	Nozzle CR
738761	ND-DLLA155P 1025	093400-1025	CP	DLC		8x0,13x155°	Nozzle CR
738768	ND-DLLA155P 1044	093400-1044	CP	DLC		6x0,17x155°	Nozzle CR
73877	ND-DLLA145P 1049	093400-1049	CP	DLC		8x0,215x145°	Nozzle CR
73881	ND-DLLA150P 1052	093400-1052	CP	DLC		8x0,205x150°	Nozzle CR
73882	ND-DLLA155P 1062	093400-1062	CP	DLC		8x0,13x155°	Nozzle CR
73890	ND-DLLA155P 1090	093400-1090	CP	DLC		7x0,185x155°	Nozzle CR
73896	ND-DLLA158P 1096	093400-1096	CP	DLC		7x0,17x158°	Nozzle CR
73961	G3S6		CP	DLC		Ø3.5 - 8x0,13	Nozzle CR
73968	G3S33		CP	DLC		Ø3.5 - 6x0,145	Nozzle CR

Our Ref.	Stamping	Part Number	CP	DLC	D/A	Technical Data	Description
----------	----------	-------------	----	-----	-----	----------------	-------------

Detroit Diesel

59509	522 8436	Tip 35,40,45,6S8					Nozzle
59513	522 8554	Tip HV7,8,9 S70,80,90					Nozzle
59515	522 9026	Tip N55,60,65 C55,60,65					Nozzle
59517	522 9030	Tip N65 B65 5A50,55,60					Nozzle
59519	522 9034	Tip N35,40,45,50 C40,45					Nozzle
59521	522 9184	Tip F70....105					Nozzle
59523	522 9192	Tip N70,75,80 C65 M60					Nozzle
59525	522 9256	Tip M95 N80,90					Nozzle
59529	522 9636	Tip 7A65,70,75 7C70,75					Nozzle
59531	522 9642	Tip 7A50,55,60					Nozzle
59533	522 9806	Tip FB/FC70,75,80,90					Nozzle

Doowon

76256	KP-DLLA155SM 066	105029-1320				5x0,34x155°	Nozzle
76257	KP-DLLA155SM 067	105029-1330				5x0,30x155°	Nozzle
76284	KP-DLLA160SN 644	105029-1190				5x0,29x160°	Nozzle
76301	KP-DLLA150SN 902	105029-1280				5x0,31x150°	Nozzle
763014	KP-DLLA156SN 921	105029-1290				6x0,29x156°	Nozzle
76307	KP-DLLA155PK 107					4x0,34x155°	Nozzle
76308	KP-DLLA160PN 070					5x0,28x160°	Nozzle
76310	KP-DLLA160PN 141	see 73441				5x0,30x160°	Nozzle
76312	KP-DLLA155PN 179	105029-2000				4x0,31x155°	Nozzle
76313	KP-DLLA155PN 200	105029-2020				4x0,28x155°	Nozzle
763132	KP-DLLA155PN 202	105029-2030				5x0,26x155°	Nozzle

F&M

76802	D1LMK 140/2	9431 362 353				4x0,34x140°	Nozzle
76804	D1LMK 140/4	9431 362 350				4x0,42x140°	Nozzle
76812	D1LMK 148/2					4x0,31x148°	Nozzle
76821	D1LMK 150/21	9431 362 378				3x0,29x150°	Nozzle
76824	D1LMK 150/24	9431 362 381				4x0,32x150°	Nozzle
76838	D1LMK 150/38	9431 362 386				4x0,34x150°	Nozzle
76839	D1LMK 150/39	9431 362 390				3x0,31x150°	Nozzle
76841	D1LMK 150/41	9431 362 387				4x0,37x150°	Nozzle
76842	D1LMK 150/42	9431 362 414				4x0,33x150°	Nozzle
76852	D1LMK 150/52	9431 362 412				5x0,28x150°	Nozzle
76854C	D1LMK 150/54					3x0,31x150°	Nozzle
76855C	D1LMK 150/55	9431 271 746				3x0,35x150°	Nozzle

Fiat - Iveco

72000	DLL145S 4F					4x0,27x145°	Nozzle
72005	DLL145S 19F					4x0,22x145°	Nozzle
72006	DLL145S 20F					4x0,28x145°	Nozzle
72007L	DLL145S 24F					4x0,27x145°	Nozzle
72011L	DLL160S 30F					4x0,33x160°	Nozzle
72012L	DLL145S 31F					4x0,29x145°	Nozzle
72013L	DLL140S 33F					4x0,35x140°	Nozzle
72014	DLL145S 34F					4x0,30x145°	Nozzle
72015	DLL145S 35F					4x0,25x145°	Nozzle
72016	DLL145S 36F					4x0,29x145°	Nozzle
72017L	DLL140S 37F					4x0,33x140°	Nozzle
72018L	DLL160S 38F					4x0,33x160°	Nozzle
72019L	DLL140S 39F					4x0,32x140°	Nozzle
72020	DLL160S 40F					4x0,30x160°	Nozzle

Our Ref.	Stamping	Part Number	CP	DLC	D/A	Technical Data	Description
----------	----------	-------------	----	-----	-----	----------------	-------------

Fiat - Iveco

72021L	DLL145S 43F					4x0,30x145°	Nozzle
72023L	DLL145S 50F					4x0,29x145°	Nozzle
72024	DLL150S 51F					4x0,31x150°	Nozzle
72025L	DLL160S 52F					4x0,36x160°	Nozzle
72026	DLL145S 54F					4x0,28x145°	Nozzle
72027	DLL145S 55F					4x0,28x145°	Nozzle
72028L	DLL140S 56F					3x0,44x140°	Nozzle
72029L	DLL145S 60F					4x0,33x145°	Nozzle
72030L	DLL160S 62F					4x0,37x160°	Nozzle
72031L	DLL140S 64F					3x0,36x140°	Nozzle
72032L	DLL160S 65F					4x0,38x160°	Nozzle
72033	DLL150S 67F					4x0,41x150°	Nozzle
72034	DLL150S 68F					4x0,33x150°	Nozzle
72035	DLL145S 69F					4x0,33x145°	Nozzle
72036L	DLL140S 70F					3x0,37x140°	Nozzle
72037	DLL150S 71F					4x0,34x150°	Nozzle
72038	DLL150S 72F					4x0,42x150°	Nozzle
72039	DLL145S 73F					4x0,35x145°	Nozzle
72040	DLL150S 74F					4x0,40x150°	Nozzle
72041L	DLL140S 75F					3x0,36x140°	Nozzle
72042	DLL150S 76F					4x0,36x150°	Nozzle
72043L	DLL140S 77F					3x0,45x140°	Nozzle
72044	DLL150S 78F					4x0,33x150°	Nozzle
72056	DLL145S 73W					4x0,35x145°	Nozzle
72057	DLL150S 79W					4x0,48x150°	Nozzle
72058L	DLL139S 80WS					4x0,42x139°	Nozzle
72059L	DLL139S 81WS					4x0,40x139°	Nozzle
72060C	DLL124S 500W					4x0,31x124°	Nozzle
72061C	DLL136S 501W					3x0,36x136°	Nozzle
72070CL	DLL160A 570W					4x0,29x160°	Nozzle
72080	DLL150S 600W					4x0,36x150°	Nozzle

Ford-Navistar

441005	Nozzle Assy. BC-BE	DT466E/I530E					Nozzle HEUI
441006	Nozzle Assy. BG-BJ	DT466E/I530E					Nozzle HEUI
441007	Nozzle Assy. AA/B/C/D/E/	T444E					Nozzle HEUI
441015	Nozzle Assy. BB	DT466E/I530E					Nozzle HEUI
441016	Nozzle Assy. BI	DT466E/I530E					Nozzle HEUI
441025	Nozzle Assy. BA	DT466E/I530E					Nozzle HEUI
441026	Nozzle Assy. BN	DT466E/I530E					Nozzle HEUI
441035	Nozzle Assy. BD	DT466E/I530E					Nozzle HEUI
441036	Nozzle Assy. BP	DT466E/I530E					Nozzle HEUI
441045	Nozzle Assy. BF	DT466E/I530E					Nozzle HEUI
7641005	BC - BE	Navistar DT466E/I530E	CP			5 holes x0,225	Nozzle HEUI
7641006	BG - BJ	Navistar DT466E/I530E	CP			6 holes x0,19	Nozzle HEUI
7641007	AA-AB-AC-AD-AE-AF	Navistar T444E	CP			7 holes x0,17	Nozzle HEUI
7641015	BB	Navistar DT466E/I530E	CP			5 holes x0,22	Nozzle HEUI
7641016	BI	Navistar DT466E/I530E	CP			6 holes x0,175	Nozzle HEUI
7641025	BA	Navistar DT466E/I530E	CP			5 holes x0,25	Nozzle HEUI
7641026	BN	Navistar DT466E/I530E	CP			6 holes x0,195	Nozzle HEUI
7641035	BD	Navistar DT466E/I530E	CP			5 holes x0,28	Nozzle HEUI
7641036	BP	Navistar DT466E/I530E	CP			6 holes x0,17	Nozzle HEUI
7641045	BF	Navistar DT466E/I530E	CP			5 holes x0,23	Nozzle HEUI

Our Ref.	Stamping	Part Number	CP	DLC	D/A	Technical Data	Description
----------	----------	-------------	----	-----	-----	----------------	-------------

Gardner

51001	LW	L26159				4x0,25x130°	Nozzle
51002	LX	1/3034				3x0,32x130°	Nozzle
51003	LXB	L27239				3x0,34x130°	Nozzle
51005	LXCT					3x0,41x130°	Nozzle
51006	L3					4x0,36x130°	Nozzle
51007	L3B					3x0,44x130°	Nozzle
51050	LW-LK	Std. 6,350					Needle
51051	LW-LK	Oversize 6,355					Needle
510513	LW	Oversize 6,37...over					Needle
510515	LW	Oversize 6,39...over					Needle
51060	LX	Std. 6,350					Needle
51061	LX	Oversize 6,355					Needle
510612	LX	Oversize 6,360					Needle
510613	LX	Oversize 6,365...over					Needle
51070	LXB	Std. 6,350					Needle
51071	LXB	Oversize 6,355...over					Needle
51080	L3	Std. 6,350					Needle
51081	L3	Oversize 6,355...over					Needle
51090	L3B	Std. 6,350					Needle
51091	L3B	Oversize 6,355...over					Needle
70801	LW	1/103				4x0,25x130°	Nozzle
70802	LX	1/3034				3x0,32x130	Nozzle
70803	LXB	1/3512				3x0,34x130°	Nozzle
70805	LXCT					3x0,41x130°	Nozzle
70806	L3					4x0,36x130°	Nozzle
70807	L3B					3x0,44x130°	Nozzle
76800	D800					4x0,27x130°	Nozzle

GMT

NFT22030	SF152CUB830	1Q547302/1Q529552				8x0,30x152°	Nozzle
NFT22035	SF152CUB835	1Q547303/1Q529552				8x0,35x152°	Nozzle
NFT22040	SF152CUB840	1Q529551/1Q529552				8x0,40x152°	Nozzle
NFT22045	SF152CUB845	1Q559083/1Q529552				8x0,45x152°	Nozzle
NFT23000	SF152FGM830	1Q313772/1P249415				8x0,30x152°	Nozzle
NFT23003	SF152FGM835	1Q313771/1P249415				8x0,35x152°	Nozzle
NFT23005	SF152FGM835-3G	1Q507048/1P249415				8x0,35x152°	Nozzle
NFT23057	SF157T11133/740AB					7x0,40x157°	Nozzle
NFT42201	SFF146FC1055FGM	1R219146/1P218150				10x0,55x146°	Nozzle
NFT50600	SF534275-600	1Q534275/1Q523687				1x4,5	Nozzle
NFT55100	SF0 550/11	1R510453/1P507030				1x4,5	Nozzle
NFT55110	SF0 550/13	1R523686/1Q523687				1x4,5	Nozzle

Hanshin

NHS10042	NHS10042					10x0,42x130°	Nozzle
NHS10046	NHS10046					10x0,46x130°	Nozzle
NHS10055	NHS10055					10x0,55x140°	Nozzle
NHS10060	NHS10060					10x0,60x140°	Nozzle

IFA

76701	SE170-66-1					1x0,70x33°	Nozzle
76702	SE170-66-11					1x0,70x33°	Nozzle

Leyland

51020	227563					4x0,25x140°	Nozzle
-------	--------	--	--	--	--	-------------	--------

Our Ref.	Stamping	Part Number	CP	DLC	D/A	Technical Data	Description
----------	----------	-------------	----	-----	-----	----------------	-------------

Leyland

51021	293961					4x0,28x140°	Nozzle
51022	601850					4x0,25x140°	Nozzle
51023	601878					4x0,31x140°	Nozzle
51024	602087					4x0,35x140°	Nozzle
51030	267596	Std. 6,350					Needle
51031	267596	Oversize 6,355 ... over					Needle
51040	601836	Std. 5,080					Needle
51041	601836	Oversize 5,085					Needle
510411	601836	Oversize 5,090					Needle
510412	601836	Oversize 5,095...over					Needle

L'Orange

NLG10ACA	LT-ACA					8x0,34x145°	Nozzle
NLG10ACC	LT-ACC					9x0,35x145°	Nozzle
NLG10ACF	LT-ACF					8x0,35x150°	Nozzle
NLG10ADA	LT-ADA					10x0,33x150°	Nozzle
NLG10LBD	LT-LBD					8x0,20x150°	Nozzle
NLG10LGQ	LT-LGQ					8x0,35x140°	Nozzle
NLG10LJG	LT-LJG					8x0,25x150°	Nozzle
NLG10LXA	LT-LXA					9x0,35+1x0,20	Nozzle
NLG10LXW	LT-LXW					8x0,31x150°	Nozzle
NLG10LYB	LT-LYB					7x0,36x140°	Nozzle
NLG10LZQ	LT-LZQ					8x0,36x140°	Nozzle
NLG12AAH	LLT-AAH					6x0,51x150°	Nozzle
NLG15BBE	LTO-BBE _m					5x0,45x155°	Nozzle
NLG15BBG	LTO-BBG					8x0,37x132°	Nozzle
NLG15BEV	LTO-BEV					6x0,40x130°	Nozzle
NLG15BFH	LTO-BFH					5x0,38x110°	Nozzle
NLG15BFW	LTO-BFW					4x0,50x110°	Nozzle
NLG15BGR	LTO-BGR					4x0,55x110°	Nozzle
NLG15BGZ	LTO-BGZ					8x0,36x150°	Nozzle
NLG15BHE	LTO-BHE					8x0,325x145°	Nozzle
NLG15BJH	LTO-BJH					8x0,36x150°	Nozzle
NLG15BJN	LTO-BJN					10x0,36x140°	Nozzle
NLG15BKV	LTO-BKV					10x0,39x148°	Nozzle
NLG15BKZ	LTO-BKZ					9x0,41x156°	Nozzle
NLG15BLJ	LTO-BLJ					10x0,33x150°	Nozzle
NLG15BLQ	LTO-BLQ					8x0,33x148°	Nozzle
NLG15BMQ	LTO-BMQ					7x0,41x140°	Nozzle
NLG15BMQ1	LTO BMQ					7x0,41x140°	Nozzle
NLG15BMW	LTO-BMW					8x0,33x148°	Nozzle
NLG15BNE	LTO-BNE					10x0,39x148°	Nozzle
NLG15BNG	LTO-BNG	4091878				7x0,41x145°	Nozzle
NLG15BNZ	LTO-BNZ					10x0,36x130°	Nozzle
NLG15BPF	LTO-BPF/E					8x0,325x145°	Nozzle
NLG15BPG/EV	LTO-BPG					10x0,39x148°	Nozzle
NLG15BPJ	LTO-BPJ	(IMO-17.06)				10x0,33x145°	Nozzle
NLG16089	LTO-U9089a/E					8x0,29x145°	Nozzle
NLG16108	LTO-U9108a					8x0,34x159°	Nozzle
NLG30UBQ	LU-UBQ					8x0,45x130°	Nozzle
NLG30UDR	LU-UDR					8x0,40x130°	Nozzle
NLG30UFP	LU-UFP					6x0,45x115°	Nozzle
NLG60012	VUM-T629Y					9x0,28x66°	Nozzle cap
NLG60033	VUM-U933					1x3,0	Nozzle

Our Ref.	Stamping	Part Number	CP	DLC	D/A	Technical Data	Description
L'Orange							
NLG60Y33	VUM-U933y					1x3.0	Nozzle
NLG62BAA	VUO-BAA					6x0,55x130°	Nozzle
NLG62BAC	VUO-BAC					6x0,45x130°	Nozzle
NLG62BAD	VUO-BAD					6x0,52x110°	Nozzle
NLG62BAE	VUO-BAE					6x0,40x110°	Nozzle
NLG62BAF	VUO-BAF					6x0,45x110°	Nozzle
NLG62BAG	VUO-BAG					6x0,40x130°	Nozzle
NLG62BAK	VUO-BAK					6x0,35x130°	Nozzle
NLG62BAL	VUO-BAL					6x0,30x130°	Nozzle
NLG62BAM	VUO-BAM					6x0,45x120°	Nozzle
NLG62BAN	VUO-BAN					6x0,40x120°	Nozzle
NLG62CAA	VUO-CAA					6x0,55x110°	Nozzle
NLG62CAB	VUO-CAB					6x0,55x120°	Nozzle
NLG62CAC	VUO-CAC					6x0,50x110°	Nozzle
NLG62CAD	VUO-CAD					6x0,50x120°	Nozzle
NLG62CAE	VUO-CAE					6x0,60x120°	Nozzle
NLG64136	VUO-T136g					6x0,74x110°	Nozzle cap
NLG64139	VUO-T136r					8x0,60x120°	Nozzle cap
NLG64145	VUO-T136fb					6x0,85x110°	Nozzle cap
NLG64150	VUO-T136ib	233 222 011				6x0,78x110°	Nozzle cap
NLG64268	VUO-T168b	Ex VUO-U051b				10x0,57x150°	Nozzle cap
NLG64270	VUO-T168c/E	Ex VUO-U051c/E				10x0,60x150°	Nozzle cap
NLG65906	VUO-U906					1x2.5	Nozzle
NLG65909	VUO-U909a y/E					8x0,52x130°	Nozzle
NLG65910	VUO-U910a					8x0,52x130°	Nozzle
NLG65934	VUO-U932c					1x4.0	Nozzle
NLG65935	VUO-U932d					1x4.0	Nozzle
NLG65944	VUO-U944a					6x0,60x110°	Nozzle
NLG65945	VUO-U944b					6x0,60x135°	Nozzle
NLG65946	VUO-U944c					6x0,65x110°	Nozzle
NLG66744	VUO-U954acy/E					8x0,60x140°	Nozzle
NLG66746	VUO-U954aey/E					6x0,55x130°	Nozzle
NLG66748	VUO-U954afy/E					8x0,53x140°	Nozzle
NLG66750	VUO-U954by/E					9x0,42x130°	Nozzle
NLG66752	VUO-U954fy/E					6x0,50x110°	Nozzle
NLG66754	VUO-U954gy/E					6x0,55x110°	Nozzle
NLG66954	VUO-U955a/E					5x0,55x120°	Nozzle
NLG66956	VUO-U955b/E					9x0,42x130°	Nozzle
NLG66957	VUO-U955c/E					9x0,40x130°	Nozzle
NLG66958	VUO-U955d/E					9x0,45x130°	Nozzle
NLG66959	VUO-U955e/E					5x0,60x110°	Nozzle
NLG66960	VUO-U955f/E					6x0,55x110°	Nozzle
NLG66961	VUO-U955g/E					6x0,60x110°	Nozzle
NLG66962	VUO-U955h/E					6x0,50x110°	Nozzle
NLG66963	VUO-U955k/E					8x0,60x140°	Nozzle
NLG66964	VUO-U955i/E					6x0,45x110°	Nozzle
NLG66965	VUO-U955l/E					8x0,47x140°	Nozzle
NLG66966	VUO-U955m/E					8x0,53x140°	Nozzle
NLG67050	VUO-U967L					9x0,50x140°	Nozzle
NLG67052	VUO-U967L/Y	Heavy Oil				9x0,50x140°	Nozzle
NLG67169	VUO-U969a					1x4.0	Nozzle
NLG67376	VUO-U976a/E					9x0,48x155°	Nozzle
NLG67383	VUO-U976l/E					10x0,48x160°	Nozzle
NLG67388	VUO-U976p/E					7x0,48x150°	Nozzle

<i>Our Ref.</i>	<i>Stamping</i>	<i>Part Number</i>	<i>CP</i>	<i>DLC</i>	<i>D/A</i>	<i>Technical Data</i>	<i>Description</i>
L'Orange							
NLG67389	VUO-U976q/E					10x0,50x150°	Nozzle
NLG67808	VUO-U988a/E	01267 9421341				9x0,48x155°	Nozzle
NLG68C99	VUO-U999c/E					9x0,51x130°	Nozzle
NLG69A14	VUO-U9014a/E					8x0,54x140°	Nozzle
NLG70034	VUO-U9034b/E					10x0,53x150°	Nozzle
NLG70137	VUO-U9037c/E					12x0,50x150°	Nozzle
NLG70279	VUO-U9179c/EE					12x0,51x150°	Nozzle
NLG72104	VUY-U904a					5x0,55x140°	Nozzle
NLG72106	VUY-U904c					5x0,50x140°	Nozzle
NLG72107	VUY-U904d					8x0,35x130°	Nozzle
NLG72115	VUY-U905a					10x0,46x130°	Nozzle
NLG72116	VUY-U905b					10x0,60x140°	Nozzle
NLG72117	VUY-U905c					10x0,55x140°	Nozzle
NLG72129	VUY-U909					5x0,50x140°	Nozzle
NLG72512	VUY-U912					5x0,50x140°	Nozzle
NLG74213	VVM-T213a					10x0,48x70°	Nozzle cap
NLG74214	VVM-T213b					10x0,43x70°	Nozzle cap
NLG74215	VVM-T213c					10x0,62x72°	Nozzle cap
NLG74216	VVM-T213d					8x0,30x67°	Nozzle cap
NLG74217	VVM-T213e					8x0,35x67°	Nozzle cap
NLG74218	VVM-T213f					10x0,38x70°	Nozzle cap
NLG74219	VVM-T213g					10x0,60x72°	Nozzle cap
NLG74220	VVM-T213h					10x0,40x70°	Nozzle cap
NLG74221	VVM-T213i					10x0,58x70°	Nozzle cap
NLG74222	VVM-T213k					10x0,60x70°	Nozzle cap
NLG74223	VVM-T213l					10x0,45x70°	Nozzle cap
NLG75V01	VVM-U901					1x4.50	Nozzle
NLG76135	VVO-U935K					10x0,71x150°	Nozzle
NLG76153	VVO-U953G/E					11x0,60x155°	Nozzle
NLG77A00	VVP-U900a					10x0,60x140°	Nozzle
NLG77B00	VVP-U900b					10x0,55x140°	Nozzle
NLG77C00	VVP-U900c					10x0,65x140°	Nozzle
NLG77D00	VVP-U900d					10x0,50x140°	Nozzle
NLG77E00	VVP-U900e					10x0,52x140°	Nozzle
NLG77F00	VVP-U900f					9x0,68x140°	Nozzle
NLG77I00	VVP-U900i					10x0,48x140°	Nozzle
NLG77L00	VVP-U900l					10x0,625x140°	Nozzle
NLG77M00	VVP-U900m					10x0,725x140°	Nozzle
NLG78101	VXP-U901a					10x1,00x140°	Nozzle
NLG79105	VXW-U905					1x3.0	Nozzle
NLG79301	VWM-U901	4D14552 & 4D14557				1x4,5	Nozzle
NLG79350	VWM-T950S	D140214				10x0,60x144°	Nozzle cap
NLG79502	VWW-U902a					1x2.0	Nozzle

Lucas-Bryce

41437	P1S4S 437	5643190					Pintle nozzle
70450	HL140J29D 845 P2	5680568				4x0,29x140°	Nozzle
70451	HL150J22D 828 P2	5680567				4x0,22x150°	Nozzle
70460	L001CTA	L001CTA				5x0,25x140°	Nozzle
70500	HL120S20B 249 P3					2x0,20x120°	Nozzle
70501	HL120S27D 541	5621080				4x0,27x120°	Nozzle
705015	HL120S31E940P3	9170-006D				5x0,31x120°	Nozzle
70502	HL127S36D 662 P3	5680420				4x0,36x127°	Nozzle
70503	HL130S25D 182 P2					4x0,25x130°	Nozzle

<i>Our Ref.</i>	<i>Stamping</i>	<i>Part Number</i>	<i>CP</i>	<i>DLC</i>	<i>D/A</i>	<i>Technical Data</i>	<i>Description</i>
Lucas-Bryce							
70504	HL130S26C 175 P3	5680402				3x0,26x130°	Nozzle
70505	HL130S28C 209 P3					3x0,28x130°	Nozzle
70508	HL134S25D 656 P2					4x0,25x134°	Nozzle
70509	HL135S35C 247					3x0,35x135°	Nozzle
70510	HL140S24D 397 P3	5680406				4x0,24x140°	Nozzle
70511	HL140S25C 544	5621295				3x0,25x140°	Nozzle
70512	HL140S25D 693 P2	5680564				4x0,25x140°	Nozzle
70513	HL140S25C 761	5680446				3x0,25x140°	Nozzle
70514	HL140S25D 881 P2	5680572				4x0,25x140°	Nozzle
70515	HL140S28C 545 P3					3x0,28x140°	Nozzle
70516	HL140S28D 693 P2	5680506				4x0,28x140°	Nozzle
70517	HL140S29D 502 P2					4x0,29x140°	Nozzle
70518	HL140S30D P3					4x0,30x140°	Nozzle
70519	HL141S30D 811 P2	5680451				4x0,30x141°	Nozzle
70520	HL142S32D 525 P2	5680455				4x0,32x142°	Nozzle
70521	HL150S25D 450 P2	5621120				4x0,25x150°	Nozzle
70522	HL150S26D 502 P2					4x0,26x150°	Nozzle
70524	HL150S27D 448	5620960				4x0,27x150°	Nozzle
70525	HL150S27D 548 P2	5621510				4x0,27x150°	Nozzle
70526	HL150S27D 553	5620960				4x0,27x150°	Nozzle
70528	HL150S30C 547					3x0,30x150°	Nozzle
70530	HL160S25D 379 A	5620855				4x0,25x160°	Nozzle
70531	HL160S25D 451	5621206				4x0,27x160°	Nozzle
70532	HL160S28D 752					4x0,28x160°	Nozzle
70533	HL176S27D 525 P2	5621243				4x0,27x176°	Nozzle
70534	HL176S30D 525 P2	5680403				4x0,30x140°	Nozzle
NBR10003	H0T60A823P8					1x0,60	Nozzle
NBR10167	H140T43F529					6x0,43x140°	Nozzle
NBR10242	H145T45H532P6					8x0,45x145°	Nozzle
NBR10314	H150T40L814P4	123x1098				10x0,40x150°	Nozzle
NBR10355	H155T34HP5					8x0,34x155°	Nozzle
NBR10402	H160T33FP6					6x0,33x160°	Nozzle
NBR10419	H160T36H696P4					8x0,36x160°	Nozzle
NBR10422	H160T37K904AP7	223 10232				9x0,375x160°	Nozzle
NBR10432	H160T40E464P4					5x0,40x160°	Nozzle
NBR10447	H160T40F576					6x0,40x160°	Nozzle
NBR10477	H160T45F464P4					6x045x160°	Nozzle
NBR20103	HL130T35H418P6					7+1x0,35x130°	Nozzle
NBR20114	HL132T37H200P5					8x0,37x132°	Nozzle
NBR20125	HL140T45F200P3					6x0,45x140°	Nozzle
NBR20128	HL140T48F200P4					6x0,48x140°	Nozzle
NBR20135	HL145T45H775P5					8x0,45x145°	Nozzle
NBR20149	HL150T35K200P6					9x0,35x150°	Nozzle
NBR20154	HL150T35L759P4					5+5x0,35x150°	Nozzle
NBR20158	HL150T38K775P4					9x0,38x150°	Nozzle
NBR20159	HL150T38K785P4					9x0,38x150°	Nozzle
NBR201592	HL150T40K785P4					9x0,40x150°	Nozzle
NBR20160	HL150T38L748P8					10x0,38x150°	Nozzle
NBR20182	HL150T44H718P5					8x0,44x150°	Nozzle
NBR20184	HL150T44H795P5					8x0,44x150°	Nozzle
NBR20188	HL150T50G200P4					7x0,50x150°	Nozzle
NBR20195	HL155T46K880P4					9x0,46x155°	Nozzle
NBR45344	HL150V100L744P12					10x1,00x150°	Nozzle
NBR45400	HL153V90L900P12					10x0,90x153°	Nozzle

Our Ref.	Stamping	Part Number	CP	DLC	D/A	Technical Data	Description
----------	----------	-------------	----	-----	-----	----------------	-------------

Lucas-Simms

70565	NL 123	BDLL150S 6159				4x0,25x150°	Nozzle
70570	NL 141	BDLL150S 6571				4x0,27x150°	Nozzle
70571	NL 159	BDLL150S 6582				4x0,26x150°	Nozzle
70572	NL 179	BDLL140S 6423				4x0,29x140°	Nozzle
705722	NL 222	BDLL160S 6173				4x0,25x160°	Nozzle
705724	NL 283	BDLL140S 6422				4x0,30x140°	Nozzle
70573	NL 341	BDLL140S 6581				4x0,30x140°	Nozzle
70574	NL 382	BDLL140S 6433				4x0,27x140°	Nozzle
70575	NL 395	BDLL140S 6422				4x0,30x140°	Nozzle
70576	NL 413	BDLL150S 6571				4x0,27x150°	Nozzle
70577	NL 424	BDLL140S 6422				4x0,30x140°	Nozzle
70578	NL 433	BDLL150S 6275				4x0,34x150°	Nozzle
70580	NL 461	BDLL150S 6476				4x0,31x150°	Nozzle
70581	NL 525	BDLL150S 6618				4x0,32x150°	Nozzle
70582	NL 547	BDLL140S 6608A				4x0,33x140°	Nozzle
70584	NL 558	BDLL150S 6573				4x0,29x150°	Nozzle
70585	NL 582	BDLL140S 6422				4x0,30x140°	Nozzle
70586	NL 645	BDLL140S 6422				4x0,30x140°	Nozzle

MaK

NMK15112	A1/2	280 220 014				10x0,31x140°	Nozzle
NMK15114	A1/4					12x0,34x150°	Nozzle
NMK17220	A2/2					12x0,30x140°	Nozzle
NMK18035	A3/5					12x0,33x140°	Nozzle
NMK21410	B4/1					10x0,39x140°	Nozzle
NMK30421	C2/1	DLF150VV-C3440100				12x0,40x150°	Nozzle
NMK67420	D4/2	210 220 647				10x0,43x140°	Nozzle

Man

NMA62456	2456 3711	8514910 IMO-2456				9x0,26x141°	Nozzle
----------	-----------	------------------	--	--	--	-------------	--------

Motorpal

74000	DOP 18S 160-4331					1x0,60x18°	Nozzle
74001	DOP 33S 170-4332					1x0,70x33°	Nozzle
74002	DOP150S 335-4359					3x0,35x150°	Nozzle
74003	DOP150S 427-4333					4x0,27x150°	Nozzle
740035	DOP150S 428-1416					4x0,28x150°	Nozzle
74004	DOP150S 428-4357					4x0,28x150°	Nozzle
740045	DOP160S 430-1436					4x0,30x160°	Nozzle
74006	DOP160S 430-4370					4x0,30x160°	Nozzle
74007	DOP140S 435-83					4x0,35x140°	Nozzle
74008	DOP150S 435-4356					4x0,35x150°	Nozzle
740083	DOP140S 435-4369					4x0,35x140°	Nozzle
740086	DOP132S 440-1409					4x0,40x132°	Nozzle
74009	DOP120S 525					5x0,25x120°	Nozzle
74010	DOP150S 525-53					5x0,26x150°	Nozzle
74011	DOP150S 525-1402					5x0,25x150°	Nozzle
740115	DOP150S 525-1440					5x0,25x150°	Nozzle
74012	DOP150S 525-4304					5x0,25x150°	Nozzle
74013	DOP140S 530					5x0,30x140°	Nozzle
74014	DOP140S 530-79					5x0,30x140°	Nozzle
74015	DOP115S 530-1401					5x0,30x115°	Nozzle
740153	DOP115S 530-1427					5x0,30x115°	Nozzle
740155	DOP150S 535-1417					5x0,35x150°	Nozzle

Our Ref.	Stamping	Part Number	CP	DLC	D/A	Technical Data	Description
----------	----------	-------------	----	-----	-----	----------------	-------------

Motorpal

740158C	DOP120S 535-4105					5x0,33x120°	Nozzle
74016	DOP115S 535-4358					5x0,35x115°	Nozzle
740163	DOP115S 535-4375					5x0,35x115°	Nozzle
740165	DOP160S 625-1444					6x0,25x160°	Nozzle
74017	DOP160S 625-4343					6x0,25x160°	Nozzle
74018	DOP160S 825					8x0,25x160°	Nozzle
74050	DOP152P 522-3898		CP			5x0,20x152°	Nozzle
74060	DOP122P 533-3827					5x0,34x122°	Nozzle
NMP27350	DO140T735-4501					7x0,35x140°	Nozzle

OMAP

79030	OLL160S 3273					4x0,29x160°	Nozzle
79031C	OLL160S 3273-5					4x0,29x160°	Nozzle
79035C	OLL124S 3990					4x0,31x124°	Nozzle
79043	OLL150S 7788					4x0,32x150°	Nozzle
79050L	OLL160S 7972N					4x0,32x160°	Nozzle
79057	OLL155S 8164					4x0,24x155°	Nozzle
79060C	OLL150S 8344					3x0,31x150°	Nozzle
79064C	OLL150S 8461					3x0,29x150°	Nozzle
79070	OLL150S 8770					5x0,33x150°	Nozzle
79077	OLL155S 8777					4x0,28x155°	Nozzle
79090	OLL160S 9666					4x0,24x160°	Nozzle
79091C	OLL160S 9666/5					4x0,23x160°	Nozzle
79108	OLL150M 8388					4x0,30x150°	Nozzle
79115	OLL150M 8506					4x0,30x150°	Nozzle
79125	OLL150P 9065					2x0,27+2x0,25	Nozzle
79131	OLL160P 9161					4x0,30x160°	Nozzle
79137	OLL160P 9277					2x0,30+2x0,31x160°	Nozzle
79146	OLL155P 9566					4x0,29x155°	Nozzle
79155	OLL149P 9955		CP			4x0,25x149°	Nozzle
79160	OLL150P 9966					4x0,25x150°	Nozzle
79198	OLL150P 10068		CP			4x0,19x150°	Nozzle
79217	OLL150P 11157		CP			4x0,25x150°	Nozzle
79225	OLL150M 11625		CP			4x0,23x150°	Nozzle

Perkins

76201	2646 864					4x0,35x150°	Nozzle
76205	2645L605					4x0,31x135°	Nozzle
76206	2645L606					4x0,32x151°	Nozzle
76208	2645L608					4x0,30x146°	Nozzle
76209	2645L609					4x0,30x149°	Nozzle
76211	2645L611					4x0,305x148°	Nozzle
76212	2645L612					4x0,33x140°	Nozzle
76213	2645L613					4x0,30x149°	Nozzle
76215	2645L615					4x0,32x152°	Nozzle
76216	2645L616	21-00106				4x0,30x143°	Nozzle
76217	2645L617					5x0,29x139°	Nozzle

Ruston

NRS14003	FAPC/B23060A					8x0,36x150°	Nozzle
NRS140031	FAPC/B23060A					8x0,36x150°	Nozzle
NRS14007	FAR-23000					10x0,355x160°	Nozzle
NRS140071	FAR-23000					10x0,355x160°	Nozzle
NRS20100	FVCB/B-23030					8x0,30x140°	Nozzle

Our Ref.	Stamping	Part Number	CP	DLC	D/A	Technical Data	Description
----------	----------	-------------	----	-----	-----	----------------	-------------

Ruston

NRS20201	FVEB-23030					8x0,41x155°	Nozzle
NRS20212	FVEB/B-23030					8x0,34x140°	Nozzle
NRS20223	FVEBX/B-23030					8x0,43x130°	Nozzle
NRS20244	FVEBX/B-23030A					8x0,405x130°	Nozzle
NRS20265	FVYX					5x0,50x150°	Nozzle
NRS20305	FYH/B-23030					6x0,35x160°	Nozzle
NRS20308	FYHX/B-23030					5x0,43x160°	Nozzle
NRS20327	FYM-23030					5x0,50x150°	Nozzle
NRS20330	FYMC-23030					5x0,55x150°	Nozzle
NRS20345	FYLC					5x0,55x150°	Nozzle
NRS20350	FYLX					5x0,59x150°	Nozzle
NRS30000	F65-00251B					10x0,46x150°	Nozzle
NRS76995	FYC/B 23030					3x0,30x133°	Nozzle
NRS76996	FYW/B 23030					3x0,27x140°	Nozzle

Seven Diesel

76001	71930	VM				4x0,30x160°	Nozzle
76586	1386886	Scania	CP			8x0,23x152°	Nozzle
76644	DLL145S 644	x Kaufmann					Nozzle
NBW40600	4-600-0254	B&W				5x1,3	Nozzle cap
NBW41395	577 32970 95	B&W				3x0,95	Nozzle cap
NBW45278	DL145T 278 IMO1534	MAN 16/24 WGG				8x0,27x145°	Nozzle
NBW45308	DL145T 308	B&W 16/24				8x0,30x145°	Nozzle
NBW50324	5032458R	B&W				10x0,39x148°	Nozzle
NBW6910A	VUM-U910A/E	IMO 1235				13x0,43x82°	Nozzle
NBW6910B	VUM-U910B/E	IMO 1611				13x0,39x82°	Nozzle
NBW6910C	VUM-U910C/E	IMO 1758				13x0,41x82°	Nozzle
NCR10094	CREP 094T	Crepelle				10x0,40x155°	Nozzle
NCR10108	CREP 108T	Crepelle				10x0,37x155°	Nozzle
NHM2533	H25FV1					10x0,38x155°	Nozzle
NHM3241	H32FV1					12x0,52x157°	Nozzle
NHM3242	H32FV2					12x0,53x153°	Nozzle
NNC15BPG	B28FV1	7x5				10x0,39x148°	Nozzle
NNN20161	B433120161					8x0,42x146°	Nozzle
NNN4010	B433 539 159	4010977				10x0,29x165°	Nozzle
NSB61056	NSB61056	Smit&Bolnes				1x4,50	Nozzle
NSB66056	NSB66056	Smit&Bolnes				10x0,55x134°	Nozzle cap
NVA10004	PO150 8 04	Wartsila				8x0,40x150°	Nozzle
NWK09100	NWK09100	Waukesha				6x0,12x150°	Nozzle
NZS67900	9.29.26790.0					1x0,60	Nozzle

Sigma

75000	IBMD 811 CM					6x0,30x150°	Nozzle
75001	IBMD 1043					5x0,34x5x0,35	Nozzle
75002	IBMD 5272	209 956				4x0,27x150°	Nozzle
75003	IBMD 5606 A					8x0,32x160°	Nozzle
75005	IBMD 5767	219 555				4x0,36x160°	Nozzle
75006C	IBMD 5826					4x0,39x150°	Nozzle
75007	IBMDB 1035 C	202 553				2x0,42x10°	Nozzle
75008	IBMDB 1059					3x0,52x52°	Nozzle
75009	IBMDB 5112	205 895				3x0,41x54°	Nozzle
75010	IBMDB 5113					3x0,50x52°	Nozzle
75011	IBMDB 5114	206 952				1x0,54x23°	Nozzle
75012	IBMDB 5221	209 488				1x0,58x23°	Nozzle

Our Ref.	Stamping	Part Number	CP	DLC	D/A	Technical Data	Description
----------	----------	-------------	----	-----	-----	----------------	-------------

Sigma

75014	IBMDB 5301	211 581				1x0.63x23°	Nozzle
75015	IBMDB 5330	211 958				2x0,45x27°	Nozzle
75016	IBMDB 5434	212 159				1x0,70x35°	Nozzle
75017	IBMDB 5777	219 665				2x0.46x27°	Nozzle
75021	IBRD 5659					4x0,37x160°	Nozzle

SKL

NSK10530	TA 535 130 13					5x0,35x130°	Nozzle
NSK10725	TA 725 155					7x0,25x155°	Nozzle
NSK10830	TA 830 130	651-14016				8x0.30x130°	Nozzle
NSK10835	TA 835 155 35	601-14391				8x0,35x155°	Nozzle
NSK11630	T1A 630-130					6x0,30x130°	Nozzle
NSK11730	T1A 730 130					7x0,30x130°	Nozzle
NSK13490	T2A 940 150	242.018/400-1416				9x0,40x150°	Nozzle
NSK14339	T3A 939 150					9x0,39x150°	Nozzle
NSK25730	TAF 730 130					7x0,30x130°	Nozzle
NSK25831	TAF 830 130	651-14690				8x0,30x130°	Nozzle
NSK25835	TAF 835 155 35	243.014/600-2416				8x0,35x155°	Nozzle
NSK28940	T2AF 940 150 70	243 017/301-3416				9x0,40x150°	Nozzle
NSK28960	T3AF 939 150					9x0,39x150°	Nozzle
NSK30365	U1A 365 140 7	242.001/500-2416				3x0.65x140°	Nozzle
NSK30450	U1A 450 140 6	242.001/400-1416				4x0.50x140°	Nozzle
NSK30505	U1A 5-50 140					5x0,55x140°	Nozzle
NSK30550	U1A 550 140 5	242.001/200-8416				5x0,50x140°	Nozzle
NSK30835	U1A 835 130	242.001/300-0416				8x0,35x130°	Nozzle
NSK35102	U1AF 550 140 52	243.012/900-1416				5x0.50x140°	Nozzle
NSK36205	U1AW 550 140 52	242.002/300 2416				5x0.50x140°	Nozzle
NSK36215	U1AW 575 90 17	242.011/800-0416				5x0,75x90°	Nozzle
NSK36225	U1AW 655 90 17	242.008/100-3416				6x0,55x90°	Nozzle
NSK36240	U1AW 835 130 2	242.003/900-1416				8x0.35x130°	Nozzle

Stanadyne

59333	27333						Pencil nozzle
59336	27336						Pencil nozzle
77164	ADB152M 164-7	NBM 770052				4x0,27x152°	Nozzle
77165	ADB152M 165-7	NBM 770053				4x0,31x152°	Nozzle
77168	ADB150M 168-7	NBM 770048				4x0,33x150°	Nozzle
77169	ADB155M 169-7	NBM 770000				5x0,32x155°	Nozzle
77175	ADB150M 175-7	NBM 771233				5x0,30x150°	Nozzle
77178	ADB157M 178-7	NBM 771265				8x0,23x157°	Nozzle
77179	ADB157M 179-7	NBM 771266				8x0.26x157°	Nozzle
77184	ADB140M 184-7	NBM 771234				4x0,33x140°	Nozzle
77185	ADB150M 185-7	NBM 771235				5x0,30x150°	Nozzle
77186	ADB140M 186-7	NBM 771236				5x0,30x140°	Nozzle
77200	ADB140M 200-7	NBM 771209				4x0,27x140°	Nozzle
77202	ADB140M 202-7	NBM 771210				4x0,34x140°	Nozzle
77206	ADB152M 206-7	NBM 770054				4x0,29x152°	Nozzle
77208	ADB150M 208-7	NBM 770049				4x0,36x150°	Nozzle
77213	ADB152M 213-7	NBM 770055				4x0,34x152°	Nozzle
77215	ADB160M 215-7	NBM 770047				6x0,30x160°	Nozzle
77217	ADB160M 217-7	NBM 770010				5x0.31x160°	Nozzle
77218	ADB140M 218-7	NBM 771213				5x0,25x140°	Nozzle
77219	ADB140M 219-7	NBM 771214				5x0,29x140°	Nozzle
77221	ADB140M 221-7	NBM 771225				4x0,38x140°	Nozzle

<i>Our Ref.</i>	<i>Stamping</i>	<i>Part Number</i>	<i>CP</i>	<i>DLC</i>	<i>D/A</i>	<i>Technical Data</i>	<i>Description</i>
77222	ADB140M 222-7	NBM 771226				4x0,32x140°	Nozzle
77223	ADB150M 223-7	NBM 771068				4x0,29x150°	Nozzle
77225	ADB160M 225-7	NBM 770022				4x0,35x160°	Nozzle
77226	ADB160M 226-7	NBM 770023				4x0,30x160°	Nozzle
77228	ADB150M 228-7	NBM 770050				4x0,36x150°	Nozzle
77230	ADB150M 230-7	NBM 771070				4x0,28x150°	Nozzle
77231	ADB140M 231-7	771215				5x0,30x140°	Nozzle
77232	ADB160M 232-7	NBM 770028				4x0,34x160°	Nozzle
77233	ADB140M 233-7	771227				4x0,34x140°	Nozzle
77607	29608	SDLLA155M 29608				4x0,30x155°	Nozzle
77608	29611	SDLLA155M 29611				4x0,30x154°	Nozzle
776086	29648	SDLLA150M 29648				4x0,30x149°	Nozzle
776087	29649	SDLLA145M 29649				4x0,30x146°	Nozzle
77610	29943	SDLLA142M 991				4x0,31x142°	Nozzle
776104	30064	SDLLA150M 30064				4x0,30x149°	Nozzle
776106	30146	SDLL160S 30146				4x0,275x160°	Nozzle
77611	30525	SDLLA143M 30525				5x0,25x180°	Nozzle
776111	30526	SDLLA143M 30526				5x0,24x144°	Nozzle
776113	30528	SDLLA143M 30528				5x0,26x141°	Nozzle
776114	30754	SDLLA160M 30754				4x0,21x160°	Nozzle
7761142	31057	SDLLA150M 31057				4x0,305x148°	Nozzle
7761143	31058	SDLLA150M 31058				4x0,32x152°	Nozzle
7761146	31261	SDLLA150S 6846				6x0,33x150°	Nozzle
776115	31542	SDLLA150M 31542				4x0,21x145°	Nozzle
776118	32078	SDLLA160P 32078				4x0,24x156°	Nozzle
77612	33426	SDLLA152M 33426				5x0,25x145°	Nozzle
776125	33877	NBM 33877				5x0,30x149°	Nozzle
776126	34359	DLLA152M 34359				5x0,24x152°	Nozzle
7761267	34447	ADB145M 34447				5x0,22x145°	Nozzle
77612672	34858	DSLA134M 34858				5x0,30x134°	Nozzle
7761268	34861	DSLA134M 34861				5x0,275x134°	Nozzle
7761269	34862	SDLLA150M 34862				5x0,29x139°	Nozzle
776127	35235	SDLLA145M 35235				5x0,30x141°	Nozzle
776128	35304	SDLLA145M 35304				5x0,26x142°	Nozzle
776129	35926	SDLLA152M 35926				5x0,25x152	Nozzle
7761296	39019	SDSLA143M 39019				5x0,27x143°	Nozzle
7761298	42321	SDLLA150P 42321				5x0,27x150°	Nozzle
77613	770049	NBM 770049				4x0,35x144°	Nozzle
776132	770051	NBM 770051				4x0,34x140°	Nozzle
77614	770069	NBM 770069				4x0,36x144°	Nozzle
77615	770086	NBM 770086				6x0,29x161°	Nozzle
77623	770173	NBM 770173				4x0,29x155°	Nozzle
77676	770316	NBM 770316				6x0,24x160°	Nozzle
77705	770405	NBM 770405				6x0,26x154°	Nozzle
77708C	770620	SDLLA150S 620				5x0,26x150°	Nozzle
77710	770763	NBM 770763				5x0,31x141°	Nozzle
77729	770829	NBM 770829				4x0,34x140°	Nozzle
77739	770939	NBM 770939				5x0,27x143°	Nozzle
77744	770967	NBM 770967				5x0,31x141°	Nozzle
77751	770991	NBM 770991				4x0,30x142°	Nozzle
77773	771573	NBM 771573				6x0,27x150°	Nozzle
77790	771890	NBM 771890				5x0,25x144°	Nozzle
77929	775195	DLL150S 79W				4x0,48x150°	Nozzle
77951	775234	DLL150P 451W				4x0,235x150°	Nozzle

Our Ref.	Stamping	Part Number	CP	DLC	D/A	Technical Data	Description
----------	----------	-------------	----	-----	-----	----------------	-------------

Stanadyne

77952	775702	DLL150P 452W				4x0,26x145°	Nozzle
77958	775925A	DLL145S 73W				4x0,35x145°	Nozzle

Sulzer

NSU22000	3107 092 376 200	6307/08 (BH22)				6x0,275x130°	Nozzle
NSU22001	3107 092 376 201	6307/08 (BH22)				6x0,30x160°	Nozzle
NSU22002	3107 092 376 202	6307/08 (BH22)				6x0,325x130°	Nozzle
NSU22003	3107 092 376 203	6307/08 (BH22)				6x0,375x130°	Nozzle
NSU36000	2107 102 522 200	H27240 (20/24)				7x0,28x159°	Nozzle
NSU36001	2107 102 522 201	H27240 (20/24)				7x0,26x159°	Nozzle
NSU36002	2107 102 522 202	H27240 (20/24)				8x0,22x160°	Nozzle
NSU36003	2107 102 522 203	H27240 (20/24)				8x0,26x160°	Nozzle
NSU36004	2107 102 522 204	H27240 (20/24)				9x0,23x159°	Nozzle
NSU36005	2107 102 522 205	H27240 (20/24)				9x0,25x159°	Nozzle
NSU37200	2107 232 732 200	A20/24H 400 bar				8x0,22x160°	Nozzle
NSU37201	2107 232 732 201	A20/24H 400 bar				8x0,26x160°	Nozzle
NSU37301	3107 032 144 201	H27240 (A20/24H)				7x0,32x159°	Nozzle
NSU37371	3107 070 418 201	(BH29)				8x0,275x135°	Nozzle
NSU37372	3107 070 418 202	(BH29)				7x0,275x135°	Nozzle
NSU37373	3107 070 418 203	(BH29)				8x0,35x135°	Nozzle
NSU37374	3107 070 418 204	(BH29)				8x0,40x135°	Nozzle
NSU37390	2107 232 733 200	(20/24) 400 bar				7x0,28x159°	Nozzle
NSU37391	2107 232 733 201	(20/24) 400 bar				7x0,26x159°	Nozzle
NSU37394	2107 232 733 204	(20/24) 400 bar				9x0,23x159°	Nozzle
NSU37395	2107 232 733 205	(20/24) 400 bar				9x0,25x159°	Nozzle
NSU37400	3107 104 691 200	H27240 (A20/24H)				8x0,22x160°	Nozzle
NSU37401	3107 104 691 201	H27240 (A20/24H)				8x0,26x160°	Nozzle
NSU63000	2107 034 537 200	H27240 (25/30)				9x0,325x150°	Nozzle
NSU630013	H27240	(25/30)				9x0,325x155°	Nozzle
NSU630015	H27240	(25/30)				9x0,35x155°	Nozzle
NSU63003	2107 104 541 200	H27240 (25/30)				10x0,33x158°	Nozzle
NSU63004	2107 104 541 200	H27240 (25/30)				10x0,350x158°	Nozzle
NSU63005	2107 104 541 201	H27240 (25/30)				10x0,30x158°	Nozzle
NSU63010	2107 104 696 200	H27240 (25/30)				8x0,375x158°	Nozzle
NSU630102	H27240	(25/30)				8x0,40x158°	Nozzle
NSU63011	2107 104 696 201	H27240 (25/30)				9x0,32x158°	Nozzle
NSU630114	2107 104 696 201	H27240 (25/30)				9x0,325x158°	Nozzle
NSU63012	2107 104 696 202	H27240 (25/30)				9x0,285x150°	Nozzle
NSU63013	H27240	(25/30)				9x0,30x150°	Nozzle
NSU65240	S20					12x0,24x160°	Nozzle
NSU65255	S20					12x0,255x160°	Nozzle
NSU65275	S20					12x0,275x160°	Nozzle
NSU65285	S20					12x0,285x160°	Nozzle
NSU66240	40S	KS27240 (ZA40S)				10x0,65x144°	Nozzle
NSU66242	40S	KS27240 (ZA40S)				13x0,60x160°	Nozzle
NSU68000	2107 110 718 200	K27240 (40/48)				8x0,525x160°	Nozzle
NSU68001	2107 110 718 201	K27240 (40/48)				9x0,525x160°	Nozzle
NSU68002	2107 110 718 202	K27240 (40/48)				12x0,475x160°	Nozzle
NSU68003	2107 110 718 203	K27240 (40/48)				12x0,50x160°	Nozzle
NSU68004	2107 110 718 204	K27240 (40/48)				12x0,525x160°	Nozzle
NSU68005	2107 110 718 205	K27240 (40/48)				12x0,550x160°	Nozzle
NSU68017	SU8778 1 201	K27240 (40/48)				8x0,550x160°	Nozzle
NSU69072	194.894 - 1.2	2107 194 894 (RT)				1x4	Nozzle
NSU69074	225.172 - 0.9	2107 225 172 (RT)				1x4	Nozzle

Our Ref.	Stamping	Part Number	CP	DLC	D/A	Technical Data	Description
----------	----------	-------------	----	-----	-----	----------------	-------------

Sulzer

NSU69076	252.402 - 1,6	2107 252 402 (RT)				1x4	Nozzle
----------	---------------	-------------------	--	--	--	-----	--------

Titan

NTT10307	TE 1307B					9x0,35x150°	Nozzle
----------	----------	--	--	--	--	-------------	--------

Yanmar

400011	DN4SK 1						Pintle nozzle
45204	Y150P204 BO						Nozzle
45244	Y150P244						Nozzle
76316	N16-5C					4x0,30x100°	Nozzle
76317	N16-5F	103200-53000				4x0,30x100°	Nozzle
76320	NP 35					5x0,31x148°	Nozzle
76325	Y-DLLA150S334 S0					4x0,33x150°	Nozzle
76330	Y-DLL150S 366H					6x0,36x150°	Nozzle
NYM10505	YDL150T258D	137600-53000				8x0,25x150°	Nozzle
NYM10510	YDL150T308S					8x0,30x150°	Nozzle
NYM10515	YDL150T328S					8x0,32x150°	Nozzle
NYM10526	YDL150T366D1	140677-53001				6x0,36x150°	Nozzle
NYM10540	YDL150T408S					8x0,40x150°	Nozzle
NYM15318	YDLL-140T388B					8x0,38x140°	Nozzle
NYM15353	YDLL-153288T90224C					8x0,28+4x0,22	Nozzle
NYM153531	YDLL-153288T90224C					8x0,28+4x0,22	Nozzle
NYM15363	YDLL-153348T90284C					8x0,34+4x0,28	Nozzle
NYM153631	YDLL-153348T90284C					8x0,34+4x0,28	Nozzle
NYM20288	YDLF150T288 DVH					8x0,28x150°	Nozzle
NYM20298	YDLF150T358 DV	141616-53110				8x0,35x150°	Nozzle
NYM30409	YDL135U409	159626-53011				9x0,40x135°	Nozzle
NYM30429	YDL135U459K					9x0,45x135°	Nozzle
NYM30458	YDLF150U408	Yanmar 208				8x0,40x150°	Nozzle
NYM30569	YDLF-135V569B					9x0,56x135°	Nozzle
NYM305691	YDLF-135V569B					9x0,56x135°	Nozzle

Zexel

43508	DN0PDN 108	105007-1080					Nozzle
43512	DN0PDN 112	105007-1120					Nozzle
43513	DN0PDN 113	105007-1130					Nozzle
43521	DN0PDN 121	105007-1210					Nozzle
43522	DN0PDN 122	105007-1222					Nozzle
43524	DN0PDN 124	105007-1240					Nozzle
43529	DN10PDN 129	105007-1290					Nozzle
43530	DN10PDN 130	105007-1300					Nozzle
43535	DN10PDN 135	105007-1350					Nozzle
43561	DN4PD 1	105007-1180					Nozzle
43567	DN4PD 57	105007-1260					Nozzle
73001	NP-DLL140S256NP 1	105015-0550				6x0,25x140°	Nozzle
73002	NP-DLL150S328NP 33	105015-2570				8x0,32x150°	Nozzle
73003	NP-DLL140S256NP 38	105015-2790				6x0,25x140°	Nozzle
73004	NP-DLL150S328NP 52	105015-3280				8x0,32x150°	Nozzle
73005	NP-DLL35S671NP 92	105015-3720				1x0,67x35°	Nozzle
73006	NP-DLL16S561N 389	105015-3890				1x0,56x16°	Nozzle
73008	NP-DLL155S288N 431	105015-4310				8x0,28x155°	Nozzle
73009	NP-DLL160S307N 435	105015-4350				7x0,30x160°	Nozzle
730095	NP-DLL155SN 521	105015-5210				8x0,36x155°	Nozzle
730096	NP-DLL155SN 595	105015-5950				5x0,38x155°	Nozzle

<i>Our Ref.</i>	<i>Stamping</i>	<i>Part Number</i>	<i>CP</i>	<i>DLC</i>	<i>D/A</i>	<i>Technical Data</i>	<i>Description</i>
Zexel							
730099	NP-DLL157SN 829	105015-8290				8x0,28x157°	Nozzle
73011	NP-DLLA150S334NP 3	105015-2670				4x0,33x150°	Nozzle
73012	NP-DLLA169S304NP 5	105015-2770				4x0,30x169°	Nozzle
73013	NP-DLLA166S374NP 6	105015-2780				4x0,37x166°	Nozzle
73014	NP-DLLA150S384NP 13	105015-3090				4x0,38x150°	Nozzle
73015	NP-DLLA150S404NP 13	105015-3210				4x0,40x150°	Nozzle
73016	NP-DLLA14.5S701NP 15	105015-3150				1x0,70x14,5°	Nozzle
73017	NP-DLLA150S3840NP 16	105015-3160				2x0,38+2x0,40	Nozzle
73018	NP-DLLA166S414NP 46	105015-3100				2x0,37+2x0,40	Nozzle
73019	NP-DLLA152S324NP 48	105015-3240				4x0,32x152°	Nozzle
730191	NP-DLLA152S344NP 48	105015-3220				4x0,34x152°	Nozzle
73020	NP-DLLA160S354NP 49	105015-3690				4x0,35x160°	Nozzle
73021	NP-DLLA154S344NP 54	105015-3310				4x0,34x154°	Nozzle
73022	NP-DLLA156S344NP 55	105015-3330				4x0,34x156°	Nozzle
73023	NP-DLLA171S374NP 58	105015-3360				2x0,33+2x0,36	Nozzle
73024	NP-DLLA168S304NP 59	105015-3370				4x0,30x168°	Nozzle
730249	NP-DLLA166S384NP 72	105015-3510				2x0,35+2x0,37	Nozzle
73025	NP-DLLA150S384NP 73	105015-3520				4x0,38x150°	Nozzle
73026	NP-DLLA150S394NP 76	105015-3550				2x0,35+2x0,38	Nozzle
730269	NP-DLLA176S324NP 80	105015-3590				4x0,33x176°	Nozzle
73027	NP-DLLA154S324NP 81	105015-3600				4x0,32x154°	Nozzle
73028	NP-DLLA150S344NP 82	105015-3610				4x0,34x150°	Nozzle
73029	NP-DLLA150S414NP 83	105015-3620				4x0,41x150°	Nozzle
73030	NP-DLLA151S354NP 86	105015-3650				4x0,35x151°	Nozzle
73031	NP-DLLA160S354NP 88	105015-3670				4x0,35x160°	Nozzle
73032	NP-DLLA150S334NP 89	105015-3680				4x0,33x150°	Nozzle
73033	NP-DLLA155S334NP 96	105015-3760				2x0,31+2x0,33	Nozzle
73034	NP-DLLA166S384NP 97	105015-3770				4x0,38x166°	Nozzle
73035	NP-DLLA150S334N 385	105015-3850				4x0,33x150°	Nozzle
73036	NP-DLLA154S284N 393	105015-3930				4x0,28x154°	Nozzle
730361	NP-DLLA144S354N 403	105015-4030				4x0,35x144°	Nozzle
7303611	NP-DLLA160S354N 405	105015-4050				4x0,35x160°	Nozzle
730362	NP-DLLA152S354N 406	105015-4060				4x0,35x152°	Nozzle
730363	NP-DLLA138S364N 409	105015-4090				4x0,36x138°	Nozzle
730364	NP-DLLA150S394N 411	105015-4110				2x0,36+2x0,39	Nozzle
73037	NP-DLLA154S324N 413	105015-4130				4x0,32x154°	Nozzle
730371	NP-DLLA150S374N 414	105015-4140				2x0,34+2x0,37	Nozzle
73038	NP-DLLA137S374N 417	105015-4170				4x0,37x137°	Nozzle
730381	NP-DLLA154S334N 419	105015-4190				4x0,33x154°	Nozzle
73039	NP-DLLA160S295N 422	105015-4220				5x0,29x160°	Nozzle
73040	NP-DLLA154S344N 424	105015-4240				4x0,34x154°	Nozzle
73041	NP-DLLA160S385N 426	105015-4260				5x0,38x160°	Nozzle
730412	NP-DLLA160S424N 427	105015-4270				4x0,42x160°	Nozzle
73042	NP-DLLA146S394N 430	105015-4300				2x0,37+2x0,39	Nozzle
730425	NP-DLLA105S304N 433	105015-4330				4x0,30x105°	Nozzle
73044	NP-DLLA158S325N 437	105015-4370				5x0,32x158°	Nozzle
73045	NP-DLLA154S374N 438	105015-4380				4x0,37x154°	Nozzle
73046	NP-DLLA146S344N 439	105015-4390				4x0,34x146°	Nozzle
730460	NP-DLLA154S324N 451	105015-4510				4x0,32x154°	Nozzle
7304602	NP-DLLA150S394N 452	105015-4520				2x0,36+2x0,38	Nozzle 2 springs
730461	NP-DLLA145S344N 453	105015-4530				4x0,34x145°	Nozzle
730462	NP-DLLA146S394N 455	105015-4550				4x0,39x146°	Nozzle
730463	NP-DLLA155S324N 456	105015-4560				2x0,29+2x0,31	Nozzle
730464	NP-DLLA162S384N 457	105015-4570				2x0,34+2x0,38	Nozzle

<i>Our Ref.</i>	<i>Stamping</i>	<i>Part Number</i>	<i>CP</i>	<i>DLC</i>	<i>D/A</i>	<i>Technical Data</i>	<i>Description</i>
Zexel							
730467	NP-DLLA155S365N 458	105015-4580				5x0,36x155°	Nozzle
73047	NP-DLLA154S424N 459	105015-4590				4x0,42x154°	Nozzle
730478	NP-DLLA150S334N 462	105015-4620				4x0,33x150°	Nozzle
730479	NP-DLLA150S374N 464	105015-4640				2x0,34+2x0,37	Nozzle
73048	NP-DLLA150S355N 467	105015-4670				5x0,35x150°	Nozzle
730480	NP-DLLA155S324N 468	105015-4680				4x0,32x155°	Nozzle
730481	NP-DLLA150S424N 470	105015-4700				2x0,40+2x0,42	Nozzle 2 springs
73049	NP-DLLA154S304N 474	105015-4740				4x0,30x154°	Nozzle
730495	NP-DLLA150S285N 484	105015-4840				5x0,28x150°	Nozzle
73050	NP-DLLA150S424N 493	105015-4930				4x0,42x150°	Nozzle
73051	NP-DLLA103S314N 495	105015-4950				4x0,31x103°	Nozzle
73120	NP-DLLA142S354N 502	105015-5020				4x0,35x142°	Nozzle
73121	NP-DLLA133SN 504	105015-5040				5x0,36x133°	Nozzle
73122	NP-DLLA160S325N 507	105015-5070				5x0,32x160°	Nozzle 2 springs
73123	NP-DLLA155SN 515	105015-5150				5x0,30x155°	Nozzle
73124	NP-DLLA151SN 517	105015-5170				4x0,31x151°	Nozzle
73128	NP-DLLA145SN 523	105015-5230				4x0,29x145°	Nozzle
73132	NP-DLLA155SN 532	105015-5320				5x0,28x155°	Nozzle
73133	NP-DLLA154SN 533	105015-5330				4x0,37x154°	Nozzle 2 springs
73135	NP-DLLA160SN 539	105015-5390				4x0,37x160°	Nozzle 2 springs
73138	NP-DLLA148SN 545	105015-5450				4x0,37x148°	Nozzle 2 springs
73140	NP-DLLA142S344N 547	105015-5470				4x0,34x142°	Nozzle 2 springs
731401	NP-DLLA150SN 548	105015-5480				4x0,40x150°	Nozzle 2 springs
73141	NP-DLLA150SN 555	105015-5550				2x0,37+2x0,40	Nozzle 2 springs
73143	NP-DLLA160SN 564	105015-5640				5x0,29x160°	Nozzle
73145	NP-DLLA160SN 566	105015-5660				4x0,32x160°	Nozzle
73146	NP-DLLA160SN 567	105015-5670				5x0,31x160°	Nozzle
73160	NP-DLLA143SN 580	105015-5800				5x0,37x143°	Nozzle 2 springs
73164	NP-DLLA142SN 582	105015-5820				2x0,33+2x0,35	Nozzle
73166	NP-DLLA154SN 586	105015-5860				4x0,33x154°	Nozzle
73170	NP-DLLA154SN 606	105015-6060				4x0,30x154°	Nozzle
73171	NP-DLLA154SN 607	105015-6070				4x0,32x154°	Nozzle
73175	NP-DLLA150SN 615	105015-6150				5x0,34x150°	Nozzle 2 springs
73177	NP-DLLA150SN 623	105015-6230				5x0,30x150°	Nozzle 2 springs
73178	NP-DLLA154SN 625	105015-6250				4x0,35x154°	Nozzle 2 springs
73180	NP-DLLA140SN 634	105015-6340				5x0,36x140°	Nozzle 2 springs
731801	NP-DLLA155SN 635	105015-6350				4x0,33x155°	Nozzle
73181	NP-DLLA158SN 638	105015-6380				5x0,30x158°	Nozzle
731812	NP-DLLA154SN 640	105015-6400				4x0,31x154°	Nozzle
731816	NP-DLLA144SN 649	105015-6490				5x0,27x144°	Nozzle
73182	NP-DLLA154SN 665	105015-6651				5x0,32x154°	Nozzle 2 springs
731821	NP-DLLA160SN 670	105015-6700				8x0,34x160°	Nozzle
731822	NP-DLLA160SN 671	105015-6710				5x0,31x160°	Nozzle 2 springs
731823	NP-DLLA152SN 681	105015-6810				5x0,36x152°	Nozzle 2 springs
731827	NP-DLLA155SN 687	105015-6870				5x0,31x155°	Nozzle 2 springs
73183	NP-DLLA148SN 693	105015-6930				4x0,37x148°	Nozzle 2 springs
73185	NP-DLLA160SN 698	105015-6980				5x0,30x160°	Nozzle
73186	NP-DLLA150SN 702	105015-7020				5x0,36x150°	Nozzle 2 springs
73188	NP-DLLA142SN 718	105015-7180				5x0,31x142°	Nozzle
73189	NP-DLLA150SN 722	105015-7220				5x0,34x150°	Nozzle
731893	NP-DLLA155SN 727	105015-7270				5x0,30x155°	Nozzle 2 springs
73190	NP-DLLA160SN 731	105015-7310				5x0,32x160°	Nozzle 2 springs
73194	NP-DLLA153SN 736	105015-7360				5x0,30x153°	Nozzle
73195	NP-DLLA150SN 739	105015-7390				2x0,40+2x0,42	Nozzle 2 springs

<i>Our Ref.</i>	<i>Stamping</i>	<i>Part Number</i>	<i>CP</i>	<i>DLC</i>	<i>D/A</i>	<i>Technical Data</i>	<i>Description</i>
Zexel							
73196	NP-DLLA150SN 742	105015-7420				5x0,35x150°	Nozzle 2 springs
731964	NP-DLLA160SN 744	105015-7440				5x0,31x160°	Nozzle 2 springs
73197	NP-DLLA150SN 758	105015-7580				5x0,29x150°	Nozzle 2 springs
73199	NP-DLLA150SN 762	105015-7620				5x0,32x150°	Nozzle 2 springs
73208	NP-DLLA157SN 778	105015-7780				5x0,33x157°	Nozzle
73211	NP-DLLA155SN 789	105015-7890				6X0,32x155°	Nozzle 2 springs
73221	NP-DLLA158SN 821	105015-8210				5x0,29x158°	Nozzle
732216	NP-DLLA163SN 823	105015-8230				5x0,33x163°	Nozzle 2 springs
73223	NP-DLLA148SN 841	105015-8410				1x0,25+6x0,31	Nozzle 2 springs
732238	NP-DLLA150SN 843	105015-8430				6x0,34x150°	Nozzle 2 springs
73224	NP-DLLA160SN 844	105015-8440				5x0,33x160°	Nozzle 2 springs
73228	NP-DLLA157SN 848	105015-8480				5x0,32x157°	Nozzle 2 springs
73230	NP-DLLA150SN 854	105015-8540				1x0,25+6x0,31	Nozzle 2 springs
732308	NP-DLLA155SN 858	105015-8580				5x0,33x155°	Nozzle 2 springs
732309	NP-DLLA150SN 859	105015-8590				5x0,27x150°	Nozzle 2 springs
732326	NP-DLLA150SN 866	105015-8660				5x0,32x150°	Nozzle 2 springs
732329	NP-DLLA150SN 868	105015-8680				5x0,29x150°	Nozzle 2 springs
73233	NP-DLLA158SN 869	105015-8690				5x0,28x158°	Nozzle
73235	NP-DLLA150SN 871	105015-8710				6x0,29x150°	Nozzle 2 springs
73237	NP-DLLA150SN 876	105015-8760				5x0,30x150°	Nozzle
732371	NP-DLLA150SN 877	105015-8770				5x0,36x150°	Nozzle 2 springs
73239	NP-DLLA146SN 886	105015-8860				5x0,34x146°	Nozzle
73242	NP-DLLA150SN 892	105015-8920				6x0,30x150°	Nozzle 2 springs
73243	NP-DLLA160SN 893	105015-8930				5x0,27x160°	Nozzle 2 springs
73248	NP-DLLA155SN 898	105015-8980				5x0,27x155°	Nozzle
73253	NP-DLLA150SN 906	105015-9060				6x0,30x150°	Nozzle 2 springs
732535	NP-DLLA155SN 913	105015-9130				5x0,33x155°	Nozzle 2 springs
73254	NP-DLLA156SN 921	105015-9210				6x0,29x156°	Nozzle 2 springs
73255	NP-DLLA160SN 922	105015-9220				5x0,27x160°	Nozzle
73257	NP-DLLA150SN 953	105015-9530				6x0,27x150°	Nozzle 2 springs
732575	NP-DLLA155SN 955	105015-9551				6x0,31x155°	Nozzle 2 springs
73281	NP-DLLA153SN 7131	105015-7131				2x0,29+2x0,31	Nozzle
73288	NP-DLL130SM 128	105025-1280				6x0,20+6x0,27	Nozzle
732904	NP-DLLA160SM 004	105025-0040				5x0,26x160°	Nozzle 2 springs
73291	NP-DLLA150SM 018	105025-0180				6x0,27x150°	Nozzle 2 springs
73292	NP-DLLA153SM 029	105025-0290				5x0,27x153°	Nozzle
732925	NP-DLLA152SM 043	105025-0430				6x0,27x152°	Nozzle 2 springs
732931	NP-DLLA157SM 051	105025-0510				5x0,27x157°	Nozzle 2 springs
732933	NP-DLLA158SM 053	105025-0530				5x0,29x158°	Nozzle
732934	NP-DLLA157SM 054	105025-054				5x0,25x157°	Nozzle 2 springs
73294	NP-DLLA155SM 061	105025-0610				5x0,29x155°	Nozzle
732945	NP-DLLA152SM 070	105025-0700				6x0,31x152°	Nozzle 2 springs
732947	NP-DLLA158SM 073	105025-0730				5x0,34x158°	Nozzle 2 springs
73295	NP-DLLA160SM 080	105025-0800				5x0,32x160°	Nozzle
732957	NP-DLLA160SM 087	105025-0870				7x0,30x160°	Nozzle
732968	NP-DLLA150SM 116	105025-1160				5x0,29x150°	Nozzle 2 springs
732971	NP-DLLA155SM 157	105025-1570				6x0,25x155°	Nozzle 2 springs
732984	NP-DLLA149SM 304	105025-3040				5x0,26x149°	Nozzle
733019	NP-DLLA150P 9	105017-0750				4x0,31x150°	Nozzle
73303	NP-DLLA140PN 003	105017-0030				2x0,26+2x0,29	Nozzle
73304	NP-DLLA160PN 004	105017-0040				5x0,29x160°	Nozzle
73305	NP-DLLA154PN 005	105017-0051				4x0,26x154°	Nozzle
73306	NP-DLLA154PN 006	105017-0061				4x0,28x154°	Nozzle
73307	NP-DLLA154PN 007	105017-0070				5x0,27x154°	Nozzle

<i>Our Ref.</i>	<i>Stamping</i>	<i>Part Number</i>	<i>CP</i>	<i>DLC</i>	<i>D/A</i>	<i>Technical Data</i>	<i>Description</i>
Zexel							
73309	NP-DLLA152PN 009	105017-0090				4x0,30x152°	Nozzle
73310	NP-DLLA160PN 010	105017-0100				5x0,30x160°	Nozzle
73313	NP-DLLA140PN 013	105017-0130				2x0,27+2x0,29	Nozzle
73314	NP-DLLA152PN 014	105017-0140				4x0,29x152°	Nozzle
73318	NP-DLLA154PN 018	105017-0181				4x0,25x154°	Nozzle
73321	NP-DLLA150PN 021	105017-0210				4x0,34x150°	Nozzle
73325	NP-DLLA154PN 025	105017-0250				4x0,32x154°	Nozzle
73331	NP-DLLA160PN 031	105017-0310				3x0,30+2x0,32	Nozzle
73336	NP-DLLA160PN 036	105017-0360				5x0,30x160°	Nozzle
73344	NP-DLLA150PN 044	105017-0440				4x0,30x150°	Nozzle 2 springs
73349	NP-DLLA154PN 049	105017-0490				4x0,26x154°	Nozzle
73355	NP-DLLA146PN 055	105017-0550				4x0,30x146°	Nozzle
73356	NP-DLLA150PN 056	105017-0560				4x0,29x150°	Nozzle
73357	NP-DLLA155PN 057	105017-0570				3x0,26+2x0,29	Nozzle
73358	NP-DLLA154PN 058	105017-0580				4x0,30x154°	Nozzle
73361	NP-DLLA154PN 061	105017-0610				4x0,31x154°	Nozzle
73362	NP-DLLA154PN 062	105017-0620				4x0,29x154°	Nozzle
73364	NP-DLLA154PN 064	105017-0640				4x0,32x154°	Nozzle
73367	NP-DLLA154PN 067	105017-0670				4x0,26x154°	Nozzle
73368	NP-DLLA154PN 068	105017-0680				4x0,29x154°	Nozzle
73385	NP-DLLA160PN 085	105017-0850				5x0,28x160°	Nozzle
73386	NP-DLLA151PN 086	105017-0861				4x0,30x151°	Nozzle
73387	NP-DLLA154PN 087	105017-0870				4x0,28x154°	Nozzle
73388	NP-DLLA150PN 088	105017-0880				5x0,28x150°	Nozzle
73404	NP-DLLA158PN 104	105017-1040				5x0,31x158°	Nozzle
73409	NP-DLLA161PN 109	105017-1090				4x0,33x161°	Nozzle 2 springs
73416	NP-DLLA154PN 116	105017-1160				4x0,24x154°	Nozzle
73418	NP-DLLA155PN 118	105017-1180				4x0,31x155°	Nozzle
73423	NP-DLLA155PN 123	105017-1230				4x0,30x155°	Nozzle
73435	NP-DLLA160PN 135	105017-1350				5x0,28x160°	Nozzle
73441	NP-DLLA160PN 141	105017-1410				5x0,30x160°	Nozzle
73461	NP-DLLA154PN 161	105017-1610				4x0,25x154°	Nozzle
73477	NP-DLLA153PN 177	105017-1770				5x0,25x153°	Nozzle
73478	NP-DLLA153PN 178	105017-1780				5x0,25x153°	Nozzle
73479	NP-DLLA155PN 179	105017-1790				4x0,31x155°	Nozzle
73485	NP-DLLA154PN 185	105017-1850				5x0,29x154°	Nozzle
73486	NP-DLLA154PN 186	105017-1860				5x0,27x154°	Nozzle
73509	NP-DLLA158PN 209	105017-2090	CP			5x0,21x158°	Nozzle
73510	NP-DLLA146PN 218	105017-2181	CP			6x0,23x146°	Nozzle 2 springs
73511	NP-DLLA145PN 238	105017-2380	CP			5x0,215x145°	Nozzle 2 springs
73515	NP-DLLA143PN 265	105017-2650	CP			5x0,22x143°	Nozzle 2 springs
73517	NP-DLLA154PN 270	105017-2700	CP			5x0,205x154°	Nozzle 2 springs
73519	NP-DLLA155PN 276	105017-2760	CP			5x0,25x155°	Nozzle
73526	NP-DLLA148PN 306	105017-3060	CP			6x0,19x148°	Nozzle 2 springs
73535	NP-DLLA143PN 325	105019-1470	CP			5x0,25x143°	Nozzle 2 springs
73538	NP-DLLA145PN 357	105017-3570	CP			5x0,185x145°	Nozzle
73554	NP-DSLA154PN 114	105017-1140				4x0,30x154°	Nozzle 2 springs
73563	NP-DSLA149PN 903	105017-9030	CP			5x0,26x149°	Nozzle
NZX10128	DL130T328NP20	105011-0070				8x0,32x130°	Nozzle
NZX10162	DL150T268NP22	105011-9340				8x0,26x150°	Nozzle
NZX10168	DL150T288NP22	105011-9330				8x0,28x150°	Nozzle
NZX10178	DL150T348NP20	105011-9270				8x0,34x150°	Nozzle
NZX10184	DL150T388NP20	105011-9250				8x0,38x150°	Nozzle
NZX10196	DL160T306NP1	105011-2310				6x0,30x160°	Nozzle

<i>Our Ref.</i>	<i>Stamping</i>	<i>Part Number</i>	<i>CP</i>	<i>DLC</i>	<i>D/A</i>	<i>Technical Data</i>	<i>Description</i>
NZX10199	DL160T3310NP34	105018-0470				10x0,33x160°	Nozzle
NZX10205	DL160T3510NP40	105018-0450				10x0,35x160°	Nozzle
NZX10214	DL145TE324.284N4	105018-0290				4x0,28+4x0,32	Nozzle
NZX12228	DL150U428NP9	105012-0570				8x0,42x150°	Nozzle
NZX12980	DLL137TE2610					10x0,26x137°	Nozzle
NZX129801	DLL137TE2610					10x0,26x137°	Nozzle
NZX12990	DLL137TE2810					10x0,28x137°	Nozzle
NZX129901	DLL137TE2810					10x0,28x137°	Nozzle
NZX12993	DLL137TE3010					10x0,30x137°	Nozzle
NZX129931	DLL137TE3010					10x0,30x137°	Nozzle
NZX12996	DLL137TE3210					10x0,32x137°	Nozzle
NZX129961	DLL137TE3210					10x0,32x137°	Nozzle
NZX13000	DLL140TE288					8x0,28x140°	Nozzle
NZX14044	DLL140UE4410N2					10x0,44x140°	Nozzle
NZX14046	DLL140UE4610N2					10x0,46x140°	Nozzle
NZX15202	DLF130TB328N17	105011-7240				8x0,32x130°	Nozzle
NZX15204	DLF140TB304-264N3	105011-7980				4x0,30/4x0.26x140°	Nozzle
NZX15218	DLF145TB308N20	105011-6350				8x0,30x145°	Nozzle
NZX15220	DLF148TB338					8x0,33x148°	Nozzle
NZX15221	DLF145TB328					8x0,32x145°	Nozzle
NZX15223	DLF150TB268	105011-7680				8x0,26x150°	Nozzle
NZX15228	DLF150TB308	105011-7020				8x0,30x150°	Nozzle
NZX15238	DLF150TB328N23 C	105011-7450				8x0,32x150°	Nozzle
NZX15250	DLF150TB348N17	105011-7260				8x0,34x150°	Nozzle
NZX15268	DLF150TB368N27	105011-7740				8x0,36x150°	Nozzle
NZX15289	DLF150TB388N17	105011-7250				8x0,38x150°	Nozzle
NZX15306	DLF160TB306N8	105011-6640				6x0,30x160°	Nozzle
NZX15340	DLF140TE2810N6 C	105011-8460				10x0,28x140°	Nozzle
NZX153401	DLF140TE2810	105011-8460				10x0,28x140°	Nozzle
NZX15344	DLF140TE3010	105011-8470				10x0,30x140°	Nozzle
NZX153441	DLF140TE3010					10x0,30x140°	Nozzle
NZX15347	DLF140TE3210	105011-8480				10x0,32x140°	Nozzle
NZX153471	DLF140TE3210					10x0,32x140°	Nozzle
NZX15358	DLF145TE308N1 C	105011-8090				8x0,30x145°	Nozzle
NZX15364	DLF145TE324.284N3	105011-8200				4x0,32+4x0,28	Nozzle
NZX15370	DLF145TE328N1	105011-8110				8x0,32x145°	Nozzle
NZX16079	DLF150UB479N9	105012-5630				9x0,47x150°	Nozzle
NZX16152	DLF150UB52.9					9x0,49x150°	Nozzle
NZX16344	DLF150UE4410N3C					10x0,44x150°	Nozzle
NZX20100	N/P-2010-0211					13x0,39x82°	Nozzle
NZX201001	N/P-2010-0211					13x0,39x82°	Nozzle



In April 2011 we got the
UNI EN ISO 9001 approval
Seven Diesel SpA is now officially a certified company!

ISO 9001 is the internationally recognised standard for the **quality management** of businesses and it is one of the standards in the ISO 9000 family.

The ISO 9000 family of standards represents an international consensus on good quality management practices. The ISO 9001 standard provides a tried and tested framework for taking a systematic approach to managing the organization's processes so that they consistently turn out a product that satisfies customers' expectations.

We got our certification with **SGS**, the world's leading inspection, verification, testing and certification company. It's a Swiss company recognized as the global benchmark for quality and integrity, they employ more than 64,000 people and operate a network of over 1,250 offices and laboratories around the world.

Our certificate number is: IT11/0255

Certificate N. IT11/0255



The quality management system of

SEVEN DIESEL S.p.A.

Via XXV Aprile, 53 - 25038 ROVATO (BS) - Italy

has been assessed and certified as meeting the requirements of

ISO 9001 / UNI EN ISO 9001:2008

For the following activities

Design and manufacturing of injectors for diesel engines.

EA Sector: 17

This certificate is valid from 30/03/2011 until 30/03/2014 and remains valid subject to satisfactory surveillance audits.
Re certification audit due before 22/03/2014.
Issue.1. Certified since 30/03/2011.

Further clarifications regarding the scope of this certificate and the applicability of ISO 9001:2008 requirements may be obtained by consulting the organization.



Authorized by
Stefano Bertoncini

SGS ITALIA S.p.A. - Systems & Services Certification
Via G. Gozzi, 1/A 20129 MILANO - Italy
t +39 02 73 93 1 f +39 02 70 10 94 89 www.sgs.com

Page 1 of 1



This document is issued by the Company subject to its General Conditions of Certification Services accessible at www.sgs.com/terms_and_conditions.htm. Attention is drawn to the limitations of liability, indemnification and jurisdictional issues established therein. The authenticity of this document may be verified at http://www.sgs.com/clients/certified_clients.htm. Any unauthorized alteration, forgery or falsification of the content or appearance of this document is unlawful and offenders may be prosecuted to the fullest extent of the law.

graphic design atelier roger pland printed by swiss kassli security printing ltd switzerland

PRODUCT UPDATE - September 2010 (last update 30.11.2013)



Nozzles and spare parts for Denso® Common Rail Injectors suitable for many Japanese vehicles

In late 1995, Denso® launched its first common rail system and it continues to develop and improve it. In fact Denso® introduced in the European market in June 2002 a 1800-bar common rail system. Denso®'s common rail system achieved a high injection pressure and five-time multiple injections at a high accuracy. This system comfortably cleared Euro 4 emission regulations without a diesel particulate filter.

In Europe, many vehicles like Primera, Almera, Tino, and X-Trail of Nissan®, MPV and Mazda 6 of Mazda® and Avensis of Toyota® are equipped with this system. In Japan and in many other countries Hilux and Prado of Toyota® and light truck ELF of Isuzu® are equipped with this system.

Check out our nozzles for these injectors.

COMMON RAIL NOZZLES

Seven Code	Stamping	Part Number	DLC	Injector No.	Main Applications
73810	ND-DLLA155P 683	093400-6830			
73811	ND-DLLA155P 706	093400-7060			
73812	ND-DLLA154P 717	093400-7170			
738121	ND-DLLA154P 717		DLC		
73815	ND-DLLA144P 720	093400-7200			
73818	ND-DLLA145P 748	093400-7480			
73821	ND-DLLA143P 761	093400-7610		095000-056#	Komatsu
73823	ND-DLLA148P 763	093400-7630			
73824	ND-DLLA148P 764	093400-7640			
738241	ND-DLLA148P 765	093400-7650		095000-051#	Nissan 16600-8H800
73825	ND-DLLA147P 788	093400-7880		095000-094#	Toyota Hilux 23670-30030
738251	ND-DLLA147P 788		DLC		
738253	ND-K03-905				Ford Transit CX7016-9K546-AA
73826	ND-K11-766				
73829	ND-DLLA142P 793	093400-7930			
73837	ND-DLLA155P 807	093400-8070			Toyota 23670-30060
738371	ND-DLLA155P 807		DLC		
73840	ND-DLLA148P 817	093400-8170		095000-508#	Opel Combo, Corsa and Meriva 8-97313861#
738401	ND-DLLA148P 817		DLC		
738409	ND-DLLA158P 834	093400-8340	DLC	095000-522#	FIAT Ducato 2.2L 6C1Q-9K546-AC
73841	ND-DLLA150P 835	093400-8350	DLC	095000-521#	Hino P11C
738417	ND-DLLA155P 840	093400-8400	DLC		
73842	ND-DLLA155P 842	093400-8420	DLC	095000-659#	Hino J08
73843	ND-DLLA158P 844	093400-8440		095000-636#	Isuzu
73844	ND-DLLA155P 848	093400-8480	DLC	095000-635#	Hino J05
73845	ND-DLLA142P 852	093400-8520		095000-121#	Isuzu D-Max 3.0L
738454	ND-DLLA158P 854	970950-0547		095000-547#	Isuzu 4HK1/6HK1
7384541	ND-DLLA158P 854		DLC		

DLC (Diamond-Like Carbon) = needle with special black coating

COMMON RAIL NOZZLES

Seven Code	Stamping	Part Number	DLC	Injector No.	Main Applications
73846	ND-DLLA157P 855	093400-8550		095000-545#	Mitsubishi 6M60
738491	ND-DLLA152P 862	093400-8620			Isuzu 8-98055862-0
7384911	ND-DLLA152P 862		DLC		
738493	ND-DLLA155P 863	093400-8630		095000-592#	Toyota Hilux
7384931	ND-DLLA155P 863		DLC		
738494	ND-DLLA145P 864	093400-8640		095000-588# 095000-593#	Toyota Hilux 2KD 23670-09060
7384941	ND-DLLA145P 864		DLC		
738495	ND-DLLA152P 865	093400-8650		095000-551#	Isuzu 6WF1-TC
738496	ND-DLLA150P 866	093400-8660	DLC		
738497	ND-DLLA145P 870	093400-8700		095000-560#	Mitsubishi L200 1465A041
7384971	ND-DLLA145P 870		DLC		
738498	ND-DLLA148P 872	093400-8720	DLC		Nissan Navara Euro 3
738499	ND-DLLA145P 875	093400-8750			
7384991	ND-DLLA145P 875		DLC		
73851	ND-DLLA153P 884	093400-8840		095000-580#	Peugeot
738510	ND-DLLA153P 884		DLC		
738511	ND-DLLA153P 885	093400-8850	DLC		
73852	ND-DLLA139P 887	093400-8870	DLC		
73855	ND-DLLA156P 905	093400-9050			
738551	ND-DLLA156P 905		DLC		
73856	ND-DLLA150P 906	093400-9060			
73857	ND-DLLA148P 915	093400-9150			
738571	ND-DLLA148P 915		DLC		
73858	ND-DLLA150P 927	093400-9270		095000-594# 095000-622#	Wuxi Diesel 6DL1
738581	ND-DLLA150P 927		DLC		
738583	ND-DLLA148P 932	093400-9320			
7385831	ND-DLLA148P 932		DLC		
73859	ND-DLLA127P 944	093400-9440			

DLC (Diamond-Like Carbon) = needle with special black coating

COMMON RAIL NOZZLES

Seven Code	Stamping	Part Number	DLC	Injector No.	Main Applications
738593	ND-DLLA152P 947	093400-9470	DLC	095000-625#	Nissan Navara and Pathfinder 16600-EC00#
738595	ND-DLLA151P 955	093400-9550		095000-662#	Ford Transit 3.2L 7C16-9K546-AB
7385951	ND-DLLA151P 955		DLC		
738609	ND-DLLA155P 964	093400-9640		095000-679#	Shanghai Diesel 6114
73861	ND-DLLA155P 965	093400-9650		095000-670# 095000-801#	Sino Truck China
738611	ND-DLLA155P 965		DLC		
73862	ND-DLLA150P 966	093400-9660			Toyota Hiace
738621	ND-DLLA150P 966		DLC		
73867	ND-DLLA153P 977	093400-9770		095000-708#	
73870	ND-DLLA152P 980	093400-9800	DLC		Isuzu DMAX
73871	ND-DLLA152P 981	093400-9810	DLC		Isuzu DMAX
73873	ND-DLLA150P 991	093400-9910	DLC	095000-717#	
73876	ND-DLLA145P 1024	093400-1024	DLC		Toyota Hilux 2.5L D-4D
738761	ND-DLLA155P 1025	093400-1025	DLC	095000-829#	Toyota Hilux 23670-30280
738768	ND-DLLA155P 1044	093400-1044	DLC	095000-652#	
73877	ND-DLLA145P 1049	093400-1049	DLC	095000-801#	
73881	ND-DLLA150P 1052	093400-1052	DLC	095000-810#	
73882	ND-DLLA155P 1062	093400-1062	DLC		Toyota Hilux 3.0L D-4D
73890	ND-DLLA155P 1090	093400-1090	DLC	095000-679#	
73896	ND-DLLA158P 1096	093400-1096	DLC	095000-890# 095000-837#	
73961	G3S6		DLC		Toyota 23670-30400
73968	G3S33		DLC		Toyota 23670-0L110

DLC (Diamond-Like Carbon) = needle with special black coating

COMMON RAIL CONTROL VALVES AND PLUNGERS



Injector No.	Control Valve Seven Code	Plunger Seven Code	Main Applications
095000-057#	12057	14057	Toyota Avensis Verso, Previa and RAV4 23670-27030
095000-064#	12064	14064	Toyota Corolla Verso 23670-27020
095000-508#	12508	14508	Opel Combo, Corsa and Meriva 8-97313861#
095000-522#	12522	14522	FIAT
095000-547#	12547	14547	Isuzu N-Series 8-97329703-1
095000-560#	12560	14560	Mitsubishi L200 1465A041
095000-576#	12576	14576	Mitsubishi Montero and Pajero 1465A054
095000-578#	12578	14578	Mazda 3, 5 and 6 RF7J13H50
095000-580#	12580	-	Toyota
095000-593#	12593	14593	Toyota Hiace and Hilux 23670-09060
095000-602#	12602	14602	Nissan X-Trail 16600-ES60
095000-613#	12613	14613	Opel Astra, Meriva and Zafira 8-97376270#
095000-623#	12623	14623	Toyota RAV4 23670-09140
095000-635#	12635	14635	
095000-691#	12691	14691	Toyota Corolla Verso and RAV4 23670-09210

COMMON RAIL SPACERS AND PLUNGERS



Injector No.	Control Valve Seven Code	Plunger Seven Code	Main Applications
095000-697#	12697	14697	Toyota Auris, Corolla, Corolla Verso and RAV4 23670-09190
095000-703#	12703	14703	Toyota Hilux and Land Cruiser 23670-39185
095000-728#	12728	14728	Toyota Corolla Verso and RAV4 23670-09210
095000-733#	12733	14733	Toyota Auris, Corolla, Corolla Verso and RAV4 23670-09230
095000-739#	12739	14739	Toyota Hiace and Hilux 23670-39235
095000-741#	12741	14741	Toyota Hilux and Land Cruiser 23670-39215
095000-753#	12753	14753	Toyota Land Cruiser 23670-59025
095000-764#	12764	14764	Toyota Corolla Verso and RAV4 23670-09290
095000-769#	12769	14769	Toyota Auris, Corolla and RAV4 23670-09270
095000-771#	12771	14771	Toyota Land Cruiser 200 23670-59035
095000-776#	12776	14776	Toyota Hiace and Hilux 23670-39275
095000-778#	12778	14778	Toyota Hilux and Land Cruiser 23670-39315
095000-789#	12789	14789	Subaru Forester, Impreza, Legacy and Outback 16613AA020

NOW AVAILABLE!



BUTTERFLY SHUTTER (our ref. 33700)
HEMISPHERE (our ref. 33701)

PRODUCT UPDATE – March 2009 (last update 30.11.2013)

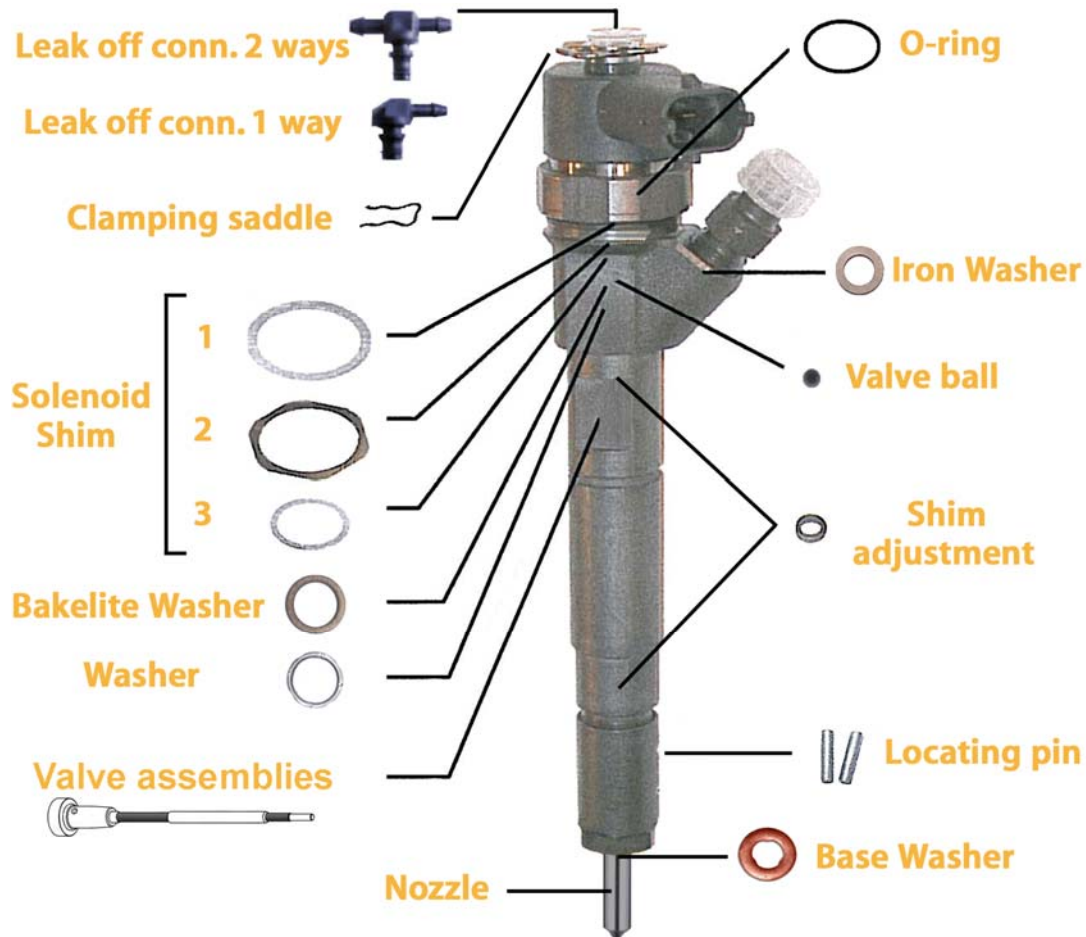

Nozzles and spare parts for Bosch® Common Rail Injectors for traditional and multijet injectors

We actually have in our line **90 nozzles** suitable for Bosch® Common Rail systems and we are now ready to offer also a wide range of spare parts for repairing injectors.

Common Rail is the present and the future and will also break through in the emerging markets in Asia as a result of increasingly strict emissions standards. Modern Common Rail diesel engines use up to 30 per cent less fuel while emitting up to 25 per cent less carbon dioxide (CO₂).

Check out in next pages our **new Common Rail products**.

COMMON RAIL NOZZLES

Seven Code	Stamping	Part Number	Main Applications
718962	DLLA155P 822	0433 171 562	Renault 420 Premium
718970	DLLA156P 889/	0433 171 594	Mercedes Sprinter 208, 308 and 408 CDI
718974	DLLA145P 926	0433 171 616	BMW 330, 530, 730 and X5
718975	DLLA145P 926+		See 718974
7190038	DLLA150P1011/	0433 171 654	Hyundai Accent, Elantra, Matrix, Santa Fe and Trajet KIA Carens II and XTREK
7190069	DLLA144P 1050	0433 171 681	Renault
719007	DLLA140P 1051	0433 171 682	Renault Midlum 150, 180, 210 and 260
7190098	DLLA160P 1063+	0433 171 690	BMW
719010	DLLA148P 1067	0433 171 693	Agrale-Deutz Furgovan and Marrua Chevrolet Blazer and S10 Marco Polo Volare V5 and V6 Nissan Frontier and X Terra Volkswagen LT 28, 35, 46
719011	DLLA150P 1076	0433 171 699	Renault 370 Kerax, 370 Premium, 470 Kerax and 470 Premium
719014	DLLA156P 1107	0433 171 712	Mercedes Sprinter, E320, S320, C200, C220, C270, CLK270, E200, E220 and E270 CDI
719016	DLLA156P 1114	0433 171 719	Hyundai H1 and Starex CRDi KIA Sorento CRDi
719021	DLLA150P 1197/		Hyundai Santa Fe CRDi-VGT
719024	DLLA148P 1221	0433 171 771	Alfa Romeo 147, 156, 166 and GT JTD FIAT Stilo JTD and Lancia Thesis JTD
719026	DLLA153P 1246++	0433 171 788	Mercedes Sprinter 316, 416 CDI, Vito and Viano CDI
719038	DLLA146P 1339	0433 171 831	MAN TGA
71904	DLLA156P 1368	0433 171 848	Hyundai Libero and Starex CRDi KIA Sorento CRDi
719041	DLLA156P 1368/		
719044	DLLA158P 1385	0433 171 860	ISUZU
71905	DLLA143P 1404	0433 171 870	Volkswagen Constellation and Volksbus
719050	DLLA146P 1405/	0433 171 871	
719051	DLLA144P 1417	0433 171 878	MAN TGA
7190551	DLLA155P 1493	0433 171 921	Mazda BT50
71905523	DLLA144P 1565	0433 171 964	KHD engine for Volvo excavator
71905526	DLLA146P 1581	0433 171 968	KHD engine for Volvo excavator
71905535	DLLA146P1610	0433 171 984	
7190554	DLLA150P 1622	0433 171 991	FAW J6 and Golden Dragon GDR1
7190556	DLLA145P 1647	0433 172 010	VM Motori
7190558	DLLA142P 1654	0433 172 015	WDEW Weichai Power Co. FOTON Auman 9.7D and Shanqi Delong 9.7D
7190559	DLLA145P 1655	0433 172 016	Weichai, CNHTC, Shanqi, JAC, FOTON
719056	DLLA151P 1656	0433 172 017	FAW
7190566	DLLA150P 1666	0433 172 022	Great Wall
7190568	DLLA82P 1668	0433 172 024	

Seven Code	Stamping	Part Number	Main Applications
719057	DLLA155P 1674	0433 172 026	BAW Fenix 3.2 FAW LD Truck 3TCK
7190578	DLLA145P 1686	0433 172 033	Weichai WP6 (or Deutz 226B)
719058	DLLA148P 1688	0433 172 034	Yuchai
7190582	DLLA152P 1690	0433 172 036	King Long
7190583	DLLA118P 1691	0433 172 037	Ford Cargo and Volkswagen Constellation
71905836	DLLA143P 1696	0433 172 039	Weichai WEC2 11.6L Eu3
71905837	DLLA118P 1697	0433 171 984	Cummins
7190586	DLLA144P 1707	0433 172 045	Dongfeng DFL/DFZ 8.9D
7190584	DLLA142P 1709	0433 172 047	Cummins ISLe
7190585	DLLA150P 1712	0433 172 049	
7190588	DLLA153P 1721	0433 172 056	
719059	DLLA146P 1724	0433 172 058	
7190591	DLLA146P 1725	0433 172 059	Weichai
719060	DLLA152P 1768	0433 172 078	Weichai
7190611	DLLA150P 1781	0433 172 088	Weichai
7190615	DLLA154P 1795	0433 172 094	Mann (Mann & Hummel)
719063	DLLA148P 1815	0433 172 108	Yuchai
7190634	DLLA152P 1819	0433 172 111	Weichai
7190637	DLLA150P 1827	0433 172 115	Yuchai 6JA Eu3
7190638	DLLA150P 1828	0433 172 116	Yuchai 6G Eu3
7190643	DLLA150P 2123	0433 172 123	Yuchai 6J Eu4
7190645	DLLA146P 2145	0433 172 145	Dodge 6.7L
71906456	DLLA141P 2146	0433 172 146	Cummins (Avalon)
7190646	DLLA143P 2155	0433 172 155	Dodge 6.7L
719065	DLLA149P 2166	0433 172 166	FAW
7190652	DLLA145P 2168	0433 172 168	Cummins (Fire Fox)
719066	DLLA148P 2221	0433 172 221	Weichai WP12 Eu4
7190662	DLLA150P 2259	0433 172 259	Yuchai
7190663	DLLA142P 2262	0433 172 262	Cummins ISDe
7190665	DLLA144P 2273	0433 172 146	Cummins ISLe Eu3
719068	DLLZ157P 964	0433 171 638	
719832	DSLA156P 736	0433 175 163	Mercedes C200, C220, C270, CLK270, E200, E220, E270, V200, V220, Sprinter and Vito CDI
719833	DSLA156P 737	0433 175 164	Mercedes A160 and A170
719835	DSLA145P 763	0433 175 175	Alfa Romeo 145, 146, 156, and 166 JTD FIAT Brava, Bravo, Marea, Marengo and Multipla JTD Lancia Kappa and Lybra JTD
719836	DSLA145P 763+		See 719835
719852	DSLA142P 795	0433 175 196	Chevrolet Tracker Citroen Berlingo, Evasion, Jumpy, Xantia and Xsara HDi FIAT Scudo and Ulysse JTD Lancia Zeta JTD Peugeot 206, 306, 406, 806, Expert and Partner HDI Suzuki Grand Vitara Tdi

Seven Code	Stamping	Part Number	Main Applications
7198544	DSLA136P 804	0433 175 203	Citroen Jumper HDi FIAT Ducato JTD Iveco Cityclass, Daily and Scudato Peugeot Boxer HDI Renault Mascott 110, 130, 140 and 150
719855	DSLA136P 804/	0433 175 203	See 7198544
719866	DSLA140P 862+	0433 175 230	Nissan Primastar dCi Opel Movano and Vivaro CDTI/DTI Renault Laguna I & II, Megane, Scenic, Trafic and Espace IV
719875	DSLA143P 970	0433 175 271	Agrale-Deutz MA and MT E-tronic Dongfeng King Long Ford Cargo C Electronic and F250 Iveco 65, 75, 80, 90, 100, 120, 130, 140, 150, 170, 180 and 320 New Holland T7060 Paz Pavlovo 3237 Volkswagen Constellation
719876	DSLA144P 971+	0433 175 272	Citroen C8, Evasion and Jumpy HDi Peugeot 806, 807 and Expert HDi
719878	DSLA144P 973+	0433 175 274	FIAT Punto JTD
719879	DSLA158P 974+	0433 175 275	GMC Isuzu
719892	DSLA144P 1021	0433 175 288	Alfa Romeo 147, 156 and 166 JTD FIAT Brava, Bravo, Doblo, Marea, Marengo and Multipla JTD Lancia Lybra JTD
7198939	DSLA140P 1033/	0433 175 297	FIAT Ducato and Daily JTD
719894	DSLA154P 1034	0433 175 298	Mercedes Sprinter 208, 211, 213, 216, 308, 311, 313, 316, 408, 411, 416 and 616
71990	DSLA143P 1058	0433 175 309	Cummins
719914	DSLA145P 1091	0433 175 318	Nissan Primastar and Interstar dCi Opel Movano and Vivaro CDTI Renault Master and Trafic DCI
719930	DSLA154P 1129/	0433 175 333	See 719956
719931	DSLA140P 1131	0433 175 334	Renault Kangoo, Megane and Scenic
719941	DSLA144P 1213	0433 175 363	FIAT Palio Weekend, Punto and Strada JTD
719951	DSLA144P 1295	0433 175 386	Alfa Romeo 147, 156 and 166 JTD FIAT Doblo, Marea, Marengo, Multipla and Stilo JTD Lancia Lybra and Thesis JTD
719954	DSLA124P 1309	0433 175 390	Cummins
719956	DSLA154P 1320	0433 175 395	Jeep Grand Cherokee CRD Mercedes Sprinter, V200, V220 and Vito
719980	DSLA142P 1474	0433 175 431	Citroen C5, Jumper, Jumpy and Xsara FIAT Scudo JTD Peugeot 206, 306, 307, 406, 607, Boxer, Expert and Partner

Seven Code	Stamping	Part Number	Main Applications
719982	DSLA128P 1510	0433 175 449	Cummins and CDC
719989	DSLA124P 1659	0433 175 470	Cummins
719993	DSLA140P 1723	0433 175 481	Dongfeng Cummins Engine Company DCEC
719997	DSLA124P 5516	0433 175 516	Dodge 5.9L
719998	DSLA143P 5519	0433 175 519	Dodge 5.9L

COMMON RAIL INJECTOR SPARE PARTS

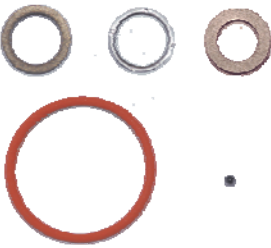
Common Rail Injector Parts Set	Seven Code	Description
	17000	with Bakelite Washer + Washer + O-ring + Iron washer + Valve ball (F00VC05001)
	17002	with Bakelite Washer + Washer + O-ring + Iron washer + Valve ball (F00VC05006)
	17004	with Bakelite Washer + Washer + O-ring + Iron washer + Valve ball (F00VC05008)

Valve Ball	Seven Code	Description
	17010	Steel - \varnothing 1,34 mm - 50 pcs. Suitable for F00VC05001
	17012	Extra strong - \varnothing 1,50 mm - 50 pcs. Suitable for F00VC05006
	17014	Silicon carbide - \varnothing 1,34 mm - 50 pcs. Suitable for F00VC05008
	17015	Extra strong - \varnothing 1,50 mm - 50 pcs. Suitable for F00VC05009

	Seven Code	17020
	Description	Parts Set with Bakelite Washer + Washer
	Suitable for	F00VC99002

	Seven Code	17030
	Description	Locating pin
	Suitable for	2433 201 024

COMMON RAIL INJECTOR SPARE PARTS

	Seven Code	17032
	Description	Iron Washer
	Suitable for	F00VC17002

	Seven Code	17034
	Description	Clamping saddle
	Suitable for	F00VC22003

	Seven Code	17036 Leak off connector 1 way
	Seven Code	17038 Leak off connector 2 ways

Description		Seven Code	
	Base washer	Total pcs. 1032 - Total items 15 (2 items are the leak off connectors 17036 and 17038)	17050
	Shim adjustment	Set \varnothing 5,43 mm - Hole \varnothing 3,40 mm - Total items 240 pcs. - 24 shims size from 1,20 to 1,70 (cut 0,02)	17060
	Solenoid shim	Type 1: Set \varnothing 23,50 mm - Hole \varnothing 19,00 mm - Total items 110 pcs. - 11 shims size from 1,00 to 1,10 mm (cut 0,01)	17070
		Type 2: Set \varnothing 22,00 mm - Hole \varnothing 19,00 mm - Total items 110 pcs. - 11 shims size from 1,00 to 1,10 mm (cut 0,01)	17071
		Type 3: Set \varnothing 15,70 mm - Hole \varnothing 10,50 mm - Total items 110 pcs. - 11 shims size from 1,20 to 1,30 mm	17072

Applications: Mercedes Sprinter, Citroen/Peugeot Hdi, FIAT Ulysse/Marea/Isuzu/VM, Ford Focus, Renault Dci/Peugeot Hdi, BMW/FIAT/SAAB 9.3, Renault Scenic, Iveco Eurocargo Tector, BMW 3.0d, Mazda 6, Citroen/Peugeot Hdi 1.4.

COMMON RAIL CRIN VALVE ASSEMBLIES

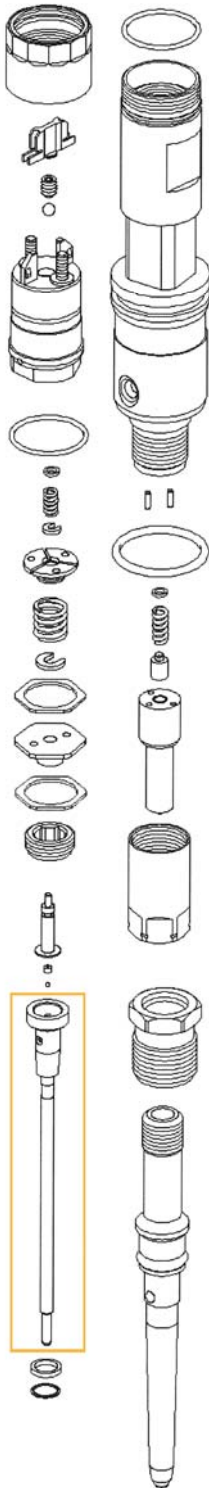

Seven Code	Suitable for	Injector No.
180005	F 00R J00 005	0445 120 002
180339	F 00R J00 339	0445 120 007/018/032/079/103
180399	F 00R J00 399	0445 120 009/010/014/015/019/020/084/085
180995	F 00R J00 995	0445 120 031
181176	F 00R J01 176	0445 120 036/119
181218	F 00R J01 218	0445 120 030/061/100
181451	F 00R J01 451	0445 120 064/065/074/136/137/138/139
181657	F 00R J01 657	0445 120 078/124
181692	F 00R J01 692	0445 120 130/149/150/169/170/191/200/ 214/227/228
181714	F 00R J01 714	0445 120 071/161/177/184/185/187/188/ 193/204
181865	F 00R J01 865	0445 120 098/099/147/148
181941	F 00R J01 941	0445 120 037/070/097/112/115/120/121/ 122/125/140/144
182005	F 00R J02 005	0445 120 008
182035	F 00R J02 035	0445 120 117/145/146/158/160/192/215
182056	F 00R J02 056	0445 120 106/142
182073	F 00R J02 073	0445 120 128/131/196
182130	F 00R J02 130	0445 120 059/060/123/132/152/209/211/212
182246	F 00R J02 246	0445 120 073
182266	F 00R J02 266	0445 120 126
182410	F 00R J02 410	0445 120 179/180/197/201/202/220/229
182454	F 00R J02 454	0445 120 025
182466	F 00R J02 466	0445 120 217/218/219

COMMON RAIL CRI VALVE ASSEMBLIES

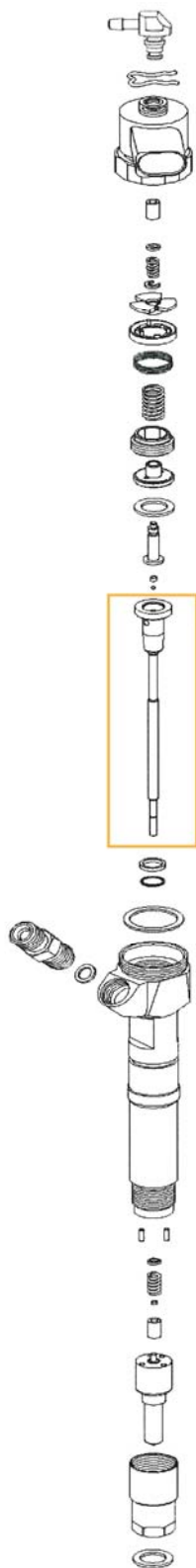

Seven Code	Suitable for	Injector No.
191001	F 00V C01 001	0445 110 003/004/010/012/015/025/035/045/ 046/069/071/073/093/094
191007	F 00V C01 007	0445 110 022/023
191015	F 00V C01 015	0445 110 059
191022	F 00V C01 022	0445 110 084/087/102/141/184
191033	F 00V C01 033	0445 110 091/092/185/186/279/283/306
191037	F 00V C01 037	0445 110 112/187
191045	F 00V C01 045	0445 110 095/099/100/104/106/107/120/121/ 151/152/170/171
191051	F 00V C01 051	0445 110 181/189/199/201/205/207/208/ 224/225
191057	F 00V C01 057	0445 110 031
191301	F 00V C01 301	0445 110 077/078/349/350
191306	F 00V C01 306	0445 110 085/142/143/153/154/214/215
191312	F 00V C01 312	0445 110 134/229
191315	F 00V C01 315	0445 110 136/188/220/239/259/271/282/285
191317	F 00V C01 317	0445 110 150/228/230
191324	F 00V C01 324	0445 110 162/163/184/193/295
191328	F 00V C01 328	0445 110 137/139/155/176/177/180/192/ 235/263/264
191334	F 00V C01 334	0445 110 183/260/309/310/316/322/331
191341	F 00V C01 341	0445 110 237/238
191346	F 00V C01 346	0445 110 253/254/257/258/269/270/329/330
191352	F 00V C01 352	0445 110 274/275/277/278
191358	F 00V C01 358	0445 110 291/358/359/366/367/386/396
191359	F 00V C01 359	0445 110 293/305/313/332/335/343/346/355/ 357/364/365/379/380/392/395
191363	F 00V C01 363	0445 110 304/317/348/370
191367	F 00V C01 367	0445 110 318/361/384/385
191368	F 00V C01 368	0445 110 321/389/390
191371	F 00V C01 371	0445 110 333/334/360/372/383

INJECTOR → NOZZLE

INJECTOR No.	NOZZLE	
	Seven Code	Stamping
0445 110 001	719835	DSLA145P 763
0445 110 002	719835	DSLA145P 763
0445 110 003	719832	DSLA156P 736
0445 110 004	719832	DSLA156P 736
0445 110 005	719833	DSLA156P 737
0445 110 006	719833	DSLA156P 737
0445 110 008	719852	DSLA142P 795
0445 110 009	719832	DSLA156P 736
0445 110 010	719832	DSLA156P 736
0445 110 011	719832	DSLA156P 736
0445 110 014	719833	DSLA156P 737
0445 110 015	719833	DSLA156P 737
0445 110 019	719941	DSLA144P 1213
0445 110 020	719852	DSLA142P 795
0445 110 021	719866	DSLA140P 862+
0445 110 024	719832	DSLA156P 736
0445 110 025	719832	DSLA156P 736
0445 110 034	718970	DLLA156P 889/
0445 110 035	718970	DLLA156P 889/
0445 110 044	719852	DSLA142P 795
0445 110 047	718974	DLLA145P 926
0445 110 057	719876	DSLA144P 971+
0445 110 064	7190038	DLLA150P1011/
0445 110 068	719892	DSLA144P 1021
0445 110 069	719894	DSLA154P 1034
0445 110 070	719894	DSLA154P 1034
0445 110 071	719832	DSLA156P 736
0445 110 072	719832	DSLA156P 736
0445 110 076	719980	DSLA142P 1474
0445 110 080	7190098	DLLA160P 1063+
0445 110 081	719010	DLLA148P 1067
0445 110 087	719914	DSLA145P 1091
0445 110 091	719016	DLLA156P 1114
0445 110 092	719016	DLLA156P 1114
0445 110 095	719014	DLLA156P 1107
0445 110 096	719014	DLLA156P 1107
0445 110 101	7190038	DLLA150P1011/
0445 110 105	719956	DSLA154P 1320
0445 110 106	719956	DSLA154P 1320
0445 110 107	719956	DSLA154P 1320
0445 110 108	719956	DSLA154P 1320
0445 110 109	719931	DSLA140P 1131
0445 110 111	719024	DLLA148P 1221
0445 110 119	719951	DSLA144P 1295

INJECTOR No.	NOZZLE	
	Seven Code	Stamping
0445 110 120	719014	DLLA156P 1107
0445 110 121	719014	DLLA156P 1107
0445 110 122	7190098	DLLA160P 1063+
0445 110 131	7190098	DLLA160P 1063+
0445 110 137	719026	DLLA153P 1246++
0445 110 138	719026	DLLA153P 1246++
0445 110 144	719931	DSLA140P 1131
0445 110 146	719866	DSLA140P 862+
0445 110 162	719026	DLLA153P 1246++
0445 110 163	719026	DLLA153P 1246++
0445 110 170	719956	DSLA154P 1320
0445 110 171	719956	DSLA154P 1320
0445 110 181	719956	DSLA154P 1320
0445 110 182	719956	DSLA154P 1320
0445 110 186	71904	DLLA156P 1368
0445 110 189	719956	DSLA154P 1320
0445 110 190	719956	DSLA154P 1320
0445 110 191	719026	DLLA153P 1246++
0445 110 192	719026	DLLA153P 1246++
0445 110 201	719014	DLLA156P 1107
0445 110 202	719014	DLLA156P 1107
0445 110 231	719010	DLLA148P 1067
0445 110 240	719980	DSLA142P 1474
0445 110 250	7190551	DLLA155P 1493
0445 110 266	718974	DLLA145P 926
0445 110 279	71904	DLLA156P 1368
0445 110 287	7190556	DLLA145P 1647
0445 110 290	719021	DLLA150P 1197/
0445 110 291	719057	DLLA155P 1674
0445 110 293	7190566	DLLA150P 1666
0445 110 305	7190568	DLLA82P 1668
0445 110 306	719016	DLLA156P 1114
0445 110 336	719010	DLLA148P 1067
0445 110 337	719010	DLLA148P 1067
0445 110 376	7190652	DLLA145P 2168
0445 120 002	7198544	DSLA136P 804
0445 120 003	718962	DLLA155P 822
0445 120 004	718962	DLLA155P 822
0445 120 006	719068	DLLZ157P 964
0445 120 007	719875	DSLA143P 970
0445 120 008	719879	DSLA158P 974+
0445 120 011	7198939	DSLA140P 1033/
0445 120 012	7190069	DLLA144P 1050
0445 120 013	7190069	DLLA144P 1050

INJECTOR → NOZZLE

INJECTOR No.	NOZZLE	
	Seven Code	Stamping
0445 120 016	719007	DLLA140P 1051
0445 120 017	719007	DLLA140P 1051
0445 120 018	71990	DSLA143P 1058
0445 120 019	719011	DLLA150P 1076
0445 120 020	719011	DLLA150P 1076
0445 120 024	719051	DLLA144P 1417
0445 120 027	719044	DLLA158P 1385
0445 120 030	719038	DLLA146P 1339
0445 120 032	719954	DSLA124P 1309
0445 120 040	719050	DLLA146P 1405/
0445 120 043	71905	DLLA143P 1404
0445 120 044	719051	DLLA144P 1417
0445 120 059	719982	DSLA128P 1510
0445 120 066	71905523	DLLA144P 1565
0445 120 067	71905526	DLLA146P 1581
0445 120 078	7190554	DLLA150P 1622
0445 120 080	71905535	DLLA146P 1610
0445 120 081	719056	DLLA151P 1656
0445 120 083	7190582	DLLA152P 1690
0445 120 084	719011	DLLA150P 1076
0445 120 086	7190559	DLLA145P 1655
0445 120 087	7190558	DLLA142P 1654
0445 120 103	719989	DSLA124P 1659
0445 120 106	7190588	DLLA153P 1721
0445 120 113	71990	DSLA143P 1058
0445 120 114	719989	DSLA124P 1659
0445 120 117	7190585	DLLA150P 1712
0445 120 120	7190583	DLLA118P 1691
0445 120 121	7190584	DLLA142P 1709
0445 120 122	7190586	DLLA144P 1707
0445 120 123	719993	DSLA140P 1723
0445 120 125	71905837	DLLA118P 1697
0445 120 127	71905836	DLLA143P 1696
0445 120 129	7190591	DLLA146P 1725
0445 120 130	719059	DLLA146P 1724
0445 120 134	71906456	DLLA141P 2146
0445 120 147	7190615	DLLA154P 1795
0445 120 149	719060	DLLA152P 1768
0445 120 150	7190611	DLLA150P 1781
0445 120 156	719063	DLLA148P 1815
0445 120 161	7190646	DLLA143P 2155
0445 120 163	7190638	DLLA150P 1828
0445 120 164	7190637	DLLA150P 1827
0445 120 165	7190643	DLLA150P 2123
0445 120 169	719060	DLLA152P 1768

INJECTOR No.	NOZZLE	
	Seven Code	Stamping
0445 120 170	7190634	DLLA152P 1819
0455 120 193	7190645	DLLA146P 2145
0445 120 200	7190591	DLLA146P 1725
0445 120 204	7190646	DLLA143P 2155
0445 120 213	719060	DLLA152P 1768
0445 120 214	719060	DLLA152P 1768
0445 120 215	719065	DLLA149P 2166
0445 120 218	719038	DLLA146P 1339
0445 120 221	7190591	DLLA146P 1725
0445 120 223	7190591	DLLA146P 1725
0445 120 225	7190662	DLLA150P 2259
0455 120 238	719997	DSLA124P 5516
0445 120 244	7190611	DLLA150P 1781
0445 120 255	719998	DSLA143P 5519
0445 120 265	719066	DLLA148P 2221
0445 120 289	7190663	DLLA142P 2262
0445 120 304	7190665	DLLA144P 2273

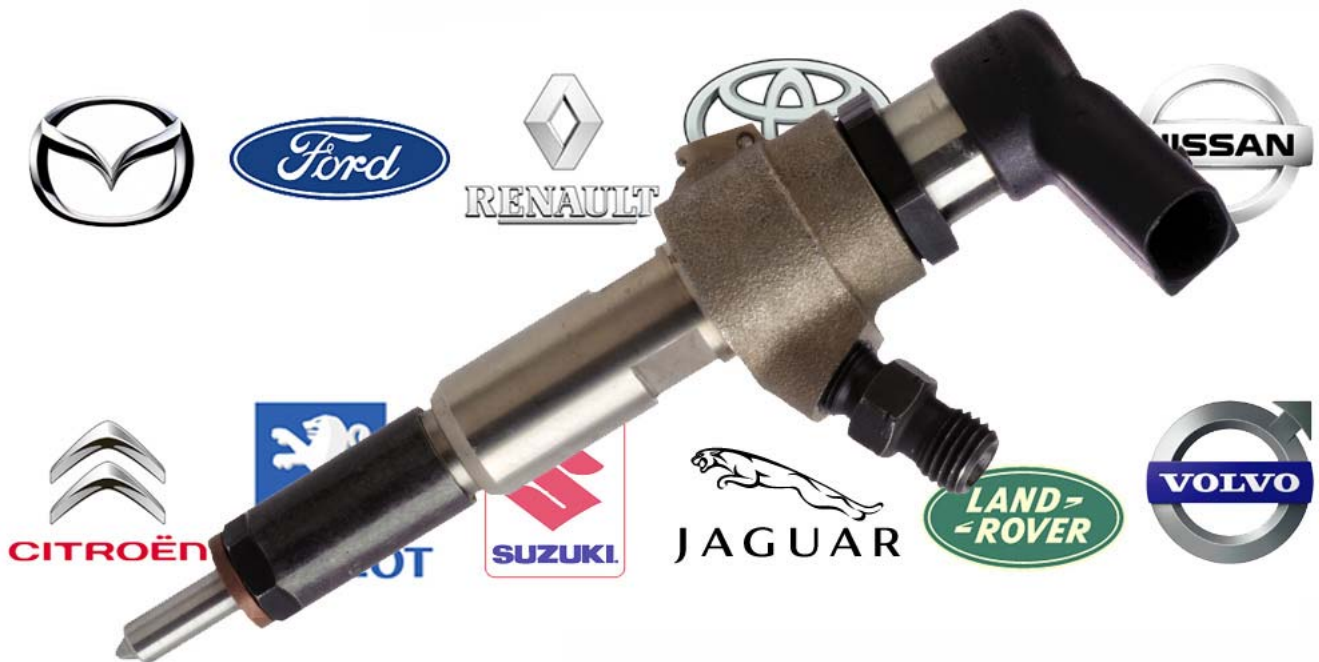

Nozzles and spares for Piezo Common Rail Injectors suitable for Continental® system (ex Siemens VDO®)

The worldwide first high-pressure diesel injection system with Piezo injectors was the forerunner Continental® Common Rail Diesel System.

The Piezo Common Rail direct injection system, the first of its kind in the automotive industry, takes common rail technology a step further by advancing the efficiency and power of diesel engines. In 2007 Continental® bought Siemens® VDO Automotive AG becoming one of the top 5 companies in the automotive industry.

These systems are very popular on Citroën®, Ford®, Jaguar®, Land Rover®, Mazda®, Nissan®, Peugeot®, Renault®, Suzuki®, Toyota®, Volvo®.

Check out our parts for these injectors.

COMMON RAIL NOZZLES

Seven Code	Stamping	Part Number	Injectors
76503	M0003P153		5WS40156-Z e 4Z
76505	M0011P162		
765053	M0019P140	CP1200946415	
76506	M0502P147.6		
76510	M0604P142		5WS40149-Z
76511	M1001P152		
76512	M1003P152		
76515	M1600P150	CP0520564718	
76520	V0600P142	CP0427353596	5WS40000-Z
76530	V0605P144	CP0412591548	5WS40148-Z
76550	V0802P150	CP0307950949 6L	
765503	V0802P150	CP0425746441 6L	
765506	V0802P150	CP0734984167 6L	
76553	V0203P152		

AVAILABLE SPARE PARTS (upon request)

Clamping saddle	Part number
	X11-800-001-001Z
	X11-800-001-002Z
	X11-800-001-003Z

Base washer	Dimensions	Note
	Ø est x Ø int x thickness	
	13,6 x 7 x 1,8	Pcs. 50
	15 x 7,3 x 1,5	Pcs. 50
	15,5 x 7,3 x 2,5	Pcs. 100
	15 x 7,3 x 2	Pcs. 50

ENGINE PCR 2.0 DW 10 TD 2.0l 64kW 2 valves	ENGINE PCR 2.0 DV 4 TD 1.4l 50kW Euro 3/4	ENGINE C3PCR 2.0 DW 10 BTED 2.0l 100kW 4 valves
<p>PUMP 5WS40018-Z</p> <p>INJECTOR 5WS40000-Z</p> <p>APPLICATIONS</p> <ul style="list-style-type: none"> • Citroën Berlingo • Citroën C5 • Citroën Xsara • Peugeot 307 • Peugeot 406 • Peugeot 407 • Peugeot Partner • Suzuki Vitara 	<p>PUMP 5WS40008-Z</p> <p>INJECTOR EURO 3 ⇒ 5WS40148-Z EURO 4 ⇒ 5WS40149-Z EURO 4 (Kyocera) ⇒ A2C59511612</p> <p>APPLICATIONS</p> <ul style="list-style-type: none"> • Citroën C1/C2/C3 • Ford Fiesta • Ford Fusion • Mazda 2 • Peugeot 107/1007 • Peugeot 307 • Toyota Aygo 	<p>PUMP 5WS40019-Z VOLVO ⇒ 5WS40163Z VOLVO NEW ⇒ A2C59511600</p> <p>INJECTOR CLASS 4 ⇒ 5WS40156-4Z CLASS 5 ⇒ 5WS40156-Z CLASS 6 ⇒ A2C59511601 DW10U-MFMA ⇒ A2C59511602 MFMA ⇒ A2C59511603</p> <p>APPLICATIONS</p> <ul style="list-style-type: none"> • Citroën C4/C5/C8 • Citroën Picasso • Ford C-Max/S-Max • Ford Galaxy • Ford Mondeo • Peugeot 307/407/607/807 • Volvo C30/S40/V50

ENGINE PCR Lion V6 2.7l 4 valves Euro 3/4	ENGINE PCR K9K 1.5l 66kW 85kW	ENGINE Lynx 1.8l 85kW 92kW
<p>PUMP A2C59511314</p> <p>INJECTOR EURO 3 ⇒ A2C59511315 EURO 4 ⇒ A2C59511316 Land Rover ⇒ A2C59511364</p> <p>APPLICATIONS</p> <ul style="list-style-type: none"> • Citroën C6 • Jaguar XJ/S-type • Land Rover Discovery • Peugeot 407/607 • Range Rover Sport 	<p>PUMP A2C59511605</p> <p>INJECTOR A2C59511606</p> <p>APPLICATIONS</p> <ul style="list-style-type: none"> • Nissan Qashqai • Renault Clio • Renault Megane • Renault Modus • Renault Scenic 	<p>PUMP A2C59511609</p> <p>INJECTOR A2C59511610 V227 ⇒ A2C59511611</p> <p>APPLICATIONS</p> <ul style="list-style-type: none"> • Ford C-Max/S-Max • Ford Connect • Ford Galaxy • Ford Mondeo

PRODUCT UPDATE - September 2012 (update 30.11.2013)



Nozzles and spare parts for Delphi® Common Rail Injectors

Since the first Delphi®-equipped Common Rail vehicle was launched in 2001, demand for these high-pressure direct injection vehicles has continued to expand. There are over 5 million Delphi® Common Rail-equipped vehicles currently on the roads. Delphi® supply the worlds largest vehicle manufacturers, including Renault®, Ford® and Kia®.

Check out in next pages our Common Rail products.

COMMON RAIL NOZZLES

Seven Code	Stamping	Part Number	Main Applications
703716	L087 PBD	C14238	
703722	L097 PBD	D2183	Hyundai Terracan, KIA Carnival and Sedona
703729	L121 PBD	L121 PBD	Ford Focus, Tourneo and Transit Connect
703733	L133 PBD	22655E	Ford Mondeo
703734	L135 PBD	L135 PBD	
70380	L087 PRD	L087 PRD	

ALSO AVAILABLE
DELPHI® CONTROL VALVE
9308-621C
 (our ref. 199621)

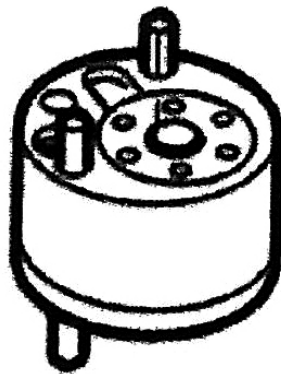

ORIGINAL DELPHI®

PRODUCT UPDATE – April 2009 (update 31.08.2011)



Gasket Kits for Common Rail Pumps suitable for Bosch®, Delphi®, Denso®, Continental® systems

Common Rail is the present and the future and will also break through in the emerging markets as a result of increasingly strict emissions standards. Modern Common Rail diesel engines use up to 30 per cent less fuel while emitting up to 25 per cent less carbon dioxide (CO₂).

We increased our line including gasket kits to repair **Common Rail Pumps**.
Our kits are equivalent to OEM and our quality standard is very high.
All our kits are made in Europe.

Check out our parts for Common Rail pumps.

COMMON RAIL PUMPS GASKET KITS

7 Code	Stamping		Suitable for	Main Applications
30601	F01M 100 275	for CP1 pump	Bosch	Alfa Romeo, FIAT, Lancia
30602	F01M 100 275S with two oil seals	for CP1 pump	Bosch	Mercedes
30603	F01M 100 276	for CP1 pump	Bosch	BMW, FIAT, Iveco, Mercedes, Peugeot, Renault
30604	F01M 100 277	for CP1 pump	Bosch	BMW, FIAT, Iveco, Mercedes, Peugeot, Renault
30605	F01M 100 278	for DRV	Bosch	
30620	F00N 201 973	for CP3 pump	Bosch	Audi, BMW, Iveco, Mercedes, Opel, Renault, VW
30621	F00N 201 974	for CP3 pump	Bosch	Audi, BMW, Iveco, Mercedes, Opel, Renault, VW
30622	F00N 201 975	for CP3 pump	Bosch	Audi, BMW, Iveco, Mercedes, Opel, Renault, VW
30623	F00N 201 976	for CP3 pump	Bosch	Audi, BMW, Iveco, Mercedes, Opel, Renault, VW
30624	F00N 201 977	for CP3 pump	Bosch	Audi, BMW, Iveco, Mercedes, Opel, Renault, VW
30625	F00N 201 978	for CP3 pump	Bosch	Audi, BMW, Iveco, Mercedes, Opel, Renault, VW
30626	F00N 201 979	for CP3 pump	Bosch	Audi, BMW, Iveco, Mercedes, Opel, Renault, VW
36601	X39-800-300-001Z		Continental	Citroën, Peugeot
36619	X39-800-300-019Z		Continental	Citroën, Ford, Mazda, Peugeot, Toyota
36620	X39-800-300-020Z		Continental	Citroën, Ford, Peugeot, Volvo
20722	7135-479A		Delphi	Citroën (C3), Ford (Focus), Nissan (Almera, Micra, XTrail)
33290	094040-0010	for HP0 pump	Denso	Mitsubishi
33295	094040-0030	for HP0 pump	Denso	John Deere tractor series 20
33601	097490-0010	for HP2 pump	Denso	Toyota (Avenis, Corolla, Previa, RAV4)
33650	294009-0030	for HP3 pump	Denso	Nissan (Almera, Primera)
33651	294009-0031	for HP3 pump	Denso	
33660	294009-0050/51	for HP4 pump	Denso	John Deere tractor series 30

PRODUCT UPDATE – February 2010 (last update 30.11.2013)

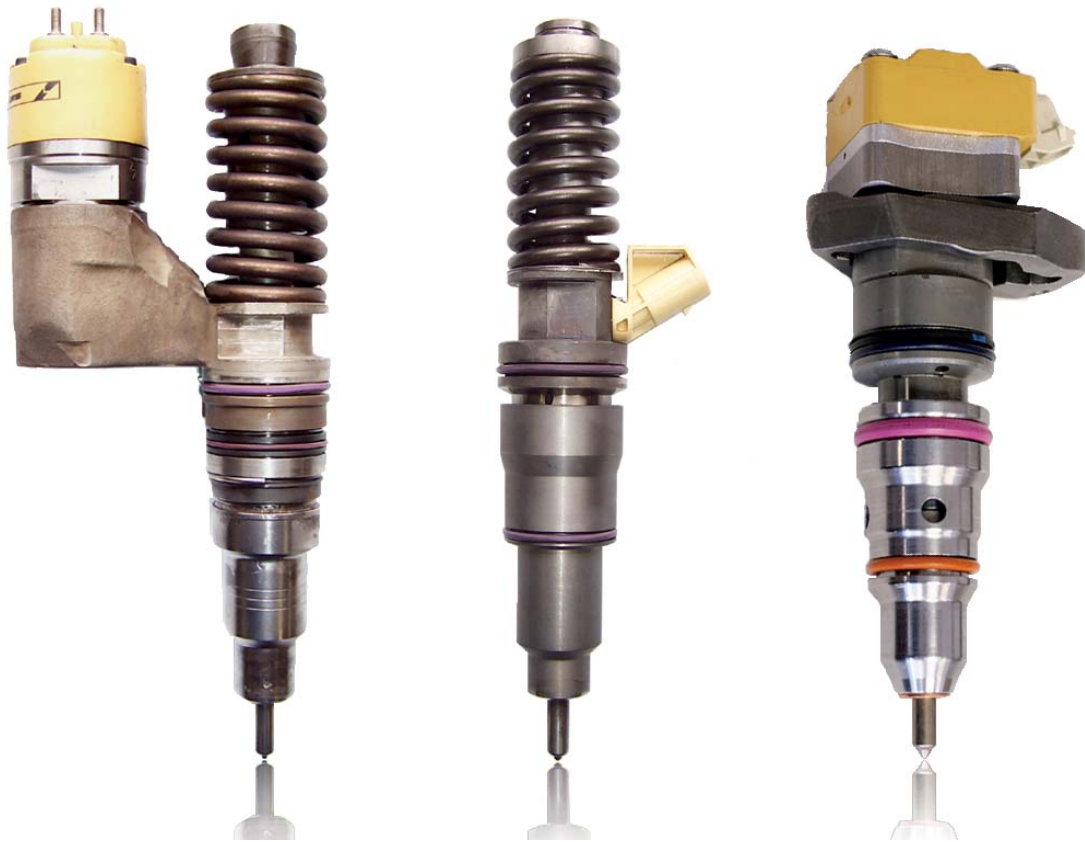

Nozzles and spare parts for Electronic Injectors EUI/EUP/HEUI Suitable for Delphi®, CAT® and Navistar® systems

The **Electronic Unit Injector (EUI)** system was developed by Delphi® in the 1990s, for use in large diesel engines, to meet the challenge posed by increasingly stringent emissions legislation. The **Electronic Unit Pump (EUP)** system is essentially the same technology as EUI but designed specifically for engines with camshafts situated within the cylinder block. The **Hydraulic Electronic Unit Injector (HEUI)** is an electronically controlled unit injector hydraulically actuated.

These systems are very popular on CAT®, John Deere® and Volvo® vehicles.

Check out our new parts for Electronic Unit Injectors.

EUI/EUP NOZZLES (suitable for DELPHI®)

Seven Code	Stamping	Part Number	Main Applications	Similar to*
70350	L010 PBB	L010 PBB	John Deere	
70351	L011 PBB	L011 PBB	John Deere	
70354	L014 PBB	L014 PBB	Volvo	
70357	L017 PBB	L017 PBB	Volvo	
70358	L018 PBB	L018 PBB		
70360	L024 PBB	L024 PBB		
70361	L029 PBB	L029 PBB		
70370	L025 PBC	L025 PBC	Volvo	L221 PBC
703702	L028 PBC	L028 PBC	Volvo	L222 PBC
703703	L045 PBC	L045 PBC	Hyundai	
7037036	L048 PBC	L048 PBC	Hyundai	
703704	L051 PBC	L051 PBC		L210 PBC
7037041	L053 PBC	L053 PBC		
7037044	L193 PBC	L193 PBC		
7037045	L194 PBC	L194 PBC		
7037046	L195 PBC	L195 PBC		
7037049	L209 PBC	L209 PBC		L050 PBC
703705	L210 PBC	L210 PBC	Renault	L051 PBC
7037052	L211 PBC	L211 PBC		
7037055	L215 PBC	L215 PBC		
703706	L216 PBC	L216 PBC	Volvo	
703708	L221 PBC	L221 PBC	Volvo	
7037082	L222 PBC	L222 PBC	Volvo	
703709	L225 PBC	L225 PBC	Volvo	L031 PBC
703710	L226 PBC	L226 PBC		L039 PBC
703711	L234 PBC	L234 PBC		
7037114	L322 PBC	L322 PBC		
7037115	L325 PBC	L325 PBC		
70374	LP004 B	LP004 B	Volvo	

* Not interchangeable. Different Volvo series.

HEUI NOZZLES (suitable for FORD-NAVISTAR® and CAT®)

Seven Code	Stamping	Part Number	Main Applications
7641005	BC - BE	Navistar DT466E/I530E	Ford-Navistar
7641006	BG - BJ	Navistar DT466E/I530E	Ford-Navistar
7641007	AA-AB-AC-AD-AE-AF	Navistar T444E	Ford-Navistar
7641015	BB	Navistar DT466E/I530E	Ford-Navistar
7641016	BI	Navistar DT466E/I530E	Ford-Navistar
7641025	BA	Navistar DT466E/I530E	Ford-Navistar
7641026	BN	Navistar DT466E/I530E	Ford-Navistar
7641035	BD	Navistar DT466E/I530E	Ford-Navistar
7641036	BP	Navistar DT466E/I530E	Ford-Navistar
7641045	BF	Navistar DT466E/I530E	Ford-Navistar
76440	106-7056		Caterpillar
7941006	OR 9348	CAT. HI300	Caterpillar
7941016	OR 9349	CAT. HI300	Caterpillar
7941026	OR 9350	CAT. HI300	Caterpillar
7941036	10R0781	CAT. HI300	Caterpillar
7941046	10R0782 + 10R1262	CAT. HI300	Caterpillar

GASKET KITS AND SPARES

Seven Code	Stamping	Part Number	Suitable for	Note
20723	7135-486	for EUI Delphi	Delphi	Actuator Kit (without actuator)
20724	7135-487	for EUI Delphi	Delphi	Adaptor plate Kit
20725	7135-488	for EUI Delphi	Delphi	Overhaul Kit
20830	7169-539	Spring for Volvo FH12 with LP004B, L014PBB or L017PBB	Delphi	Spring for Volvo FH12 with LP004B, L014PBB or L017PBB

PRODUCT UPDATE – December 2009 (last update 30.05.2013)



Nozzles and spare parts for Unit Injectors UIS/UPS suitable for Bosch® systems

The **Unit Injector System (UIS)**, also known as the pump-nozzle system, is a diesel injection system developed in 1994 by Bosch®, combining the injection pump and the injector nozzle in a single component. The **Unit Pump System (UPS)** was introduced in 1995, the feature of the UPS is that each engine cylinder has a unit pump of its own.

These systems are very popular on Audi-VW®, Iveco®, Mercedes®, Scania® and Volvo®.

Check out our parts for Unit Injectors.

UNIT INJECTOR NOZZLES

Seven Code	Stamping	Part Number	Main Applications
71887	DLLA155P 572/	0433 171 433	Volvo
718872	DLLA155P 572/+		See 71887
718882	DLLA145P 580/	0433 171 439	Irankhodro Diesel Mercedes Axor, Citaro and Travego
71891	DLLA150P 635	0433 171 470	Scania
718955	DLLA155P 765	0433 171 545	See 718969
718963	DLLA140P 826	0433 171 564	Iveco Cursor 10
718967	DLLA150P 847	0433 171 575	Scania
718968	DLLA150P 848	0433 171 576	Scania
718969	DLLA155P 872	0433 171 584	Volvo BH12, FH12, FL12, FM12 and NH12
7189691	DLLA155P 872+		See 718969
718971	DLLA143P 894/	0433 171 596	Iveco Cursor 8
718972	DLLA152P 903	0433 171 600	Volvo FH12 and FM12
718988	DLLA140P 947	0433 171 631	Iveco
71905514	DLLA145P 1534	0433 171 946	Iveco Stralis
7190552	DLLA145P 1540	0433 171 950	Iveco Stralis and Trakker
719843	DSLA150P 783	0433 175 189	Audi, Seat, Skoda and VW
719853	DSLA150P 800/		Audi, Seat, Skoda and VW
719897	DSLA150P 1042	0433 175 303	Audi, Ford, Seat, Skoda and VW
719898	DSLA150P 1043	0433 175 304	Audi, Seat, Skoda and VW
719935	DSLA150P 1156	0433 175 343	VW
719947	DSLA150P 1247	0433 175 367	Audi, Seat, Skoda and VW
7199471	DSLA150P 1248	0433 175 368	VW
719950	DSLA152P 1287++	0433 175 379	VW
719959	DSLA146P 1409+	0433 175 414	
719963	DSLA146P 1440	F002 C40 586	

UNIT INJECTOR SPARE PARTS

Seven Code	Stamping	Part Number / Description	Main Applications
301276	1417 010 996	for UIS	Audi, Mitsubishi, Skoda and VW
301277	1417 010 997	for UIS	Audi, Seat, Skoda and VW
304499	F018 B06 804	nozzle spacer for UIS	
30584	F00H N37 069	for UIS	Kässbohrer and Mercedes (012 071 00 01)
305841	F00H N37 070	for UIS	Freightliner and Mercedes (012 071 01 01)
30586	F00H N37 925	for UIS	Iveco Cursor 8 and Scania (1728288)
305861	F00H N37 926	for UIS	Volvo (3883796) (includes pressure pin F00Z B20 001 and spring 2434 614 040)
305862	F00H N37 927	for UIS	Scania
305863	F00H N37 928	for electrovalve UIS	Iveco Cursor 8, Scania and Volvo FH12-FM12-NH12
305886	F00V X99 886	part set piston for UIS	
305887	F00V X99 887	part set piston for UIS	
305892	F00V X99 992	for UIS	Volvo (276935)
305894	F00V X99 994	part set piston for UIS	Scania
305895	F00V X99 995	for UIS	Case New Holland, DTC and Iveco
305896	F00V X99 996	for UIS	Case New Holland, DTC and Iveco
305898	F00V X99 998	for UIS	Volvo
30590	F00V X99 999	for UIS	Scania (1398810 and 1422564)



304499



305886



305887



305894

PISTON VALVES

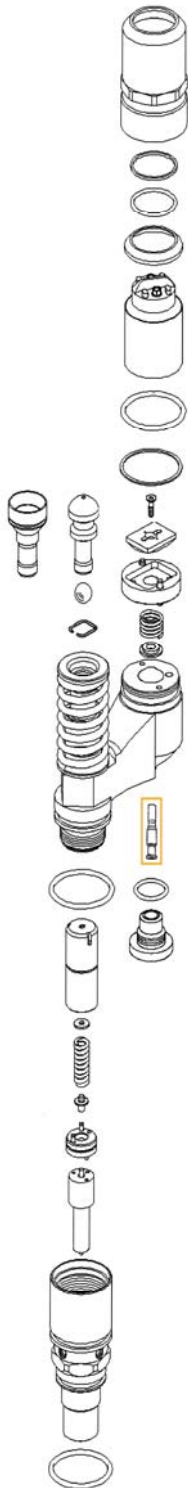

←←← UNIT INJECTOR

Seven Code	Description
307000	Ø 7,000
307005	Ø 7,005
307010	Ø 7,010
307015	Ø 7,015
307020	Ø 7,020
307025	Ø 7,025
307030	Ø 7,030

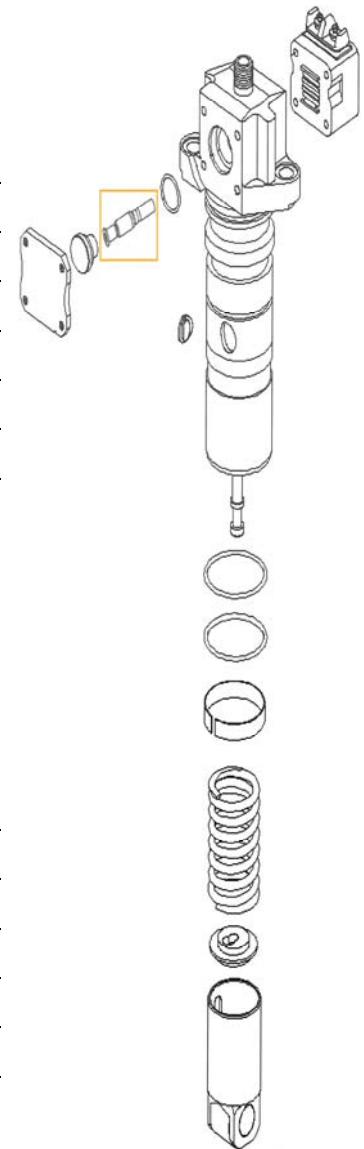

UNIT PUMP →→→

Seven Code	Description
307100	Ø 7,000
307105	Ø 7,005
307110	Ø 7,010
307115	Ø 7,015
307120	Ø 7,020
307125	Ø 7,025

Injector No.	Opening Pressure (bar)	Nozzle		Repair Kit	
0414 700 002		718882	DLLA145P 580/	305861*	F00H N37 926
0414 700 003 / 004		718971	DLLA143P 894/	305861*	F00H N37 926
0414 700 005		718963	DLLA140P 826	305861*	F00H N37 926
0414 700 006		7190552	DLLA145P 1540		
0414 701 004		71887	DLLA155P 572/	305861*	F00H N37 926
0414 701 005		71891	DLLA150P 635	305861*	F00H N37 926
0414 701 006 / 021		718963	DLLA140P 826	305861*	F00H N37 926
0414 701 007 / 020		718967	DLLA150P 847	305861*	F00H N37 926
0414 701 008 / 019		718968	DLLA150P 848	305861*	F00H N37 926
0414 701 013 / 022		718988	DLLA140P 947	305861*	F00H N37 926
0414 701 017		71891	DLLA150P 635	305861*	F00H N37 926
0414 702 002 / 003 / 005 / 010		718969	DLLA155P 872 (old DLLA155P 765)	305861*	F00H N37 926
0414 702 006		718972	DLLA152P 903	305861*	F00H N37 926
0414 720 035 / 022 / 007	288	719843	DSLA150P 783	301277	1417 010 997
0414 720 037 / 025 / 015	288	719853	DSLA150P 800/	301277	1417 010 997
0414 720 039 / 028 / 021 / 013	288	719898	DSLA150P 1043	301277	1417 010 997
0414 720 210	292	719935	DSLA150P 1156	301277	1417 010 997
0414 720 214 / 209 / 204	292	719897	DSLA150P 1042		
0414 720 215 / 213 / 208 / 206 / 202	292	719947	DSLA150P 1247	301277	1417 010 997
0414 720 231 / 216 / 131	292	7199471	DSLA150P 1248	301277	1417 010 997
0414 720 401 / 402 / 403 / 404		719950	DSLA152P 1287++		

* 305861 includes pressure pin F00Z B20 001 and spring 2434 614 040.

PRODUCT UPDATE – September 2009 (last update 15.02.2011)

For
Common
Rail



IVECO



CITROËN



RENAULT



PEUGEOT



HYUNDAI



Mercedes-Benz



SUZUKI

Pressure regulators (DRV valve) suitable for Bosch® Common Rail Pumps for all main applications

We added in our line 11 pressure regulators for **Bosch® Common Rail pumps**. The pressure regulator is attached to the body of the high pressure pump and its function is to regulate and maintain the pressure depending on the load condition of the engine. It is controlled electronically by EDC module.

Check out in next pages our **new** Common Rail products.

COMMON RAIL PRESSURE REGULATORS



Seven Code	SR2241
Suitable for	0281 002 241
Cross Reference	Mercedes Benz 611 0780 149
Main Applications	Mercede Benz A160, A170, C270, CLK270, E270, E320, G270, ML270, S320, Sprinter (208...616)



Seven Code	SR2284
Suitable for	0281 002 284
Cross Reference	-
Main Applications	Citroen Berlingo 2.0 HDI Peugeot 206, 306, 406, 806, Expert and Partner all vehicles 2.0 HDI



Seven Code	SR2445
Suitable for	0281 002 445
Cross Reference	Hyundai 31402-27000 KIA 16938
Main Applications	Hyundai Trajet 2.0 CRDi



Seven Code	SR2480
Suitable for	0281 002 480
Cross Reference	BMW 13517787537
Main Applications	BMW 330D, 330XD, 525D, 530D, 730D, X5

COMMON RAIL PRESSURE REGULATORS



Seven Code	SR2483
Suitable for	0281 002 483
Cross Reference	Renault 7701052268
Main Applications	Renault Espace III 2.2 DCi



Seven Code	SR2488
Suitable for	0281 002 488
Cross Reference	FIAT 717 184 45 or 608 166 59
Main Applications	Alfa Romeo 156 1.9 JTD, 156 2.4 JTD FIAT Brava, Bravo, Doblò, Multipla, Palio Weekend and Punto all vehicles 1.9 JTD



Seven Code	SR2493
Suitable for	0281 002 493 (replaced by 0281 002 872)
Cross Reference	PSA 1399 25 or 1933 25 Suzuki 15610-67G00
Main Applications	Citroen, Peugeot, Suzuki



Seven Code	SR2500
Suitable for	0281 002 500
Cross Reference	FIAT 9949317 IVECO 504016314 or 42538165
Main Applications	FIAT Ducato 2.8 JTD IVECO Daily 2.8 JTD Renault Mascotte

COMMON RAIL PRESSURE REGULATORS



Seven Code	SR2698
Suitable for	0281 002 698 (699)
Cross Reference	Mercedes Benz 611 078 05 49
Main Applications	Mercedes Benz A160, A170, C200, C220, C270, CLK270, E200, E220, E270, E320, E400, G270, G400, ML270, ML400, S320, S400, V200, V220, Vaneo 1.7, Vito and Sprinter (208...616)



Seven Code	SR2718
Suitable for	0281 002 718
Cross Reference	Hyundai 31402-27010
Main Applications	Hyundai Accent, Elantra, Getz, Matrix, Santa Fe, Trajet and Tucson



Seven Code	SR2872
Suitable for	0281 002 872
Cross Reference	PSA 1399 25 or 1933 25 Suzuki 15610-67G00
Main Applications	Citroen, Peugeot, Suzuki

Also available the **gasket kit for DRV valve** suitable for Bosch P/N **F01M 100 278** (our code 30605).



Inside the gasket kit: F00V D38 009 + F00V D38 011 + O-ring + F00R 0P1 466



SEVEN DIESEL defends the true "made in Italy"

Italian and European laws state that a product can be defined as "made in Italy" only if the design, drawing, manufacturing and packing phases of production are carried out entirely in Italy. The "made in Italy" marking gives the end user the ability to recognize the origin of the goods they purchased and protects those people who invest, manufacture and create jobs in Italy.

We at Seven Diesel respect this law by marking our products "made in Italy" and give our customers the certainty they are purchasing items with "made in Italy" quality standards.

"Made in Italy" quality is not random. "Made in Italy" quality means experience, know how and modern, technological machinery. "Made in Italy" quality equals our pride, our effort, our satisfaction to be able to manufacture quality products.

"Made in Italy" quality represents the history of Italy.

Please choose the real made in Italy, choose Seven Diesel products



We present
our new packing for nozzles
more environmentally friendly and anti-counterfeiting



We studied a double security system to avoid the counterfeiting of our products. An hologram label is used to seal the boxes, in case of removal the word "VOID" remains on the box, and the label cannot be used anymore. On the front label the word "SEVEN" is printed with a security ink which creates a light polarisation effect that can be seen through a special double filter.

All our new packing are completely recyclable. We are also introducing a new label manufactured with 100% recovered fibres.

This paper has been awarded the NAPM and Blue Angel recycled mark, because it is chlorine free and made without harmful chemical.



NEW LABEL

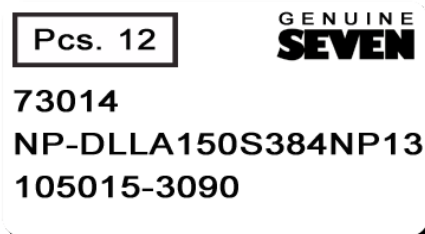

Security ink with polarisation effect visible with special filter



Our labels are 100% recycled



HOLOGRAM



VOID pattern is revealed on the label permanently if the label is tampered with and removed.

It is impossible to reuse the label once the VOID pattern is revealed.



It has recently been brought to our attention that some Chinese companies are selling low quality products and passing them off as Seven Diesel parts. We know exactly who they are and we will do all we can to stop the selling of our counterfeited products. The Seven Diesel brand is recognised in the World as a quality alternative to the genuine parts; they are trying to make profit from our brand and we can not accept that. Where practical, we also registered our trademarks, Seven® and the Seven logo®, worldwide (also in China) and they may not be used without our written permission. Any illegal use will be prosecuted.



It's now possible to pay via
Credit Card
 Easy, fast, safe!

As of September 1st, we accept credit card payments. It is easy, fast and we grant the highest security standards. All you need to do is send us the following information: type of card (we accept: VISA, AMEX, MAESTRO, MASTER CARD, DINERS), card holder name, card holder I.D. copy, credit card number, expiry date, CVV number (as shown in the picture). Please provide your credit card data per FAX or PHONE. For security reasons, we recommend that you do NOT email your credit card data.



Any further information you might require, just please feel free to ask.



**Our renewed website is online!
New life for SEVENDIESEL.IT
New features available!**



Complete online new database for an easy search of our products!



Brand new page for Seven catalogues with all our updated publications!



You can now follow us on our Official Page on Facebook and Twitter!



We have two new mini-websites for our Chinese and Spanish language friends!



All the information about the upcoming trade shows around the world where you can meet us!



All the fresh news about Seven in our homepage!

Our social links: [facebook.com/sevendiesel](https://www.facebook.com/sevendiesel) + [twitter.com/SevenDieselSpA](https://www.twitter.com/SevenDieselSpA)
Any further information you might require, just please feel free to ask.

DECEMBER, 2013

SEVEN DIESEL S.p.A. – via XXV APRILE 53, 25038 ROVATO (BS) ITALY
PHONE +39 030 7721778 – FAX +39 030 7722973 – WWW.SEVENDIESEL.IT